



SCOOBY-DOO!

75904



 [LEGO.com/scoobydoo](https://www.LEGO.com/scoobydoo)



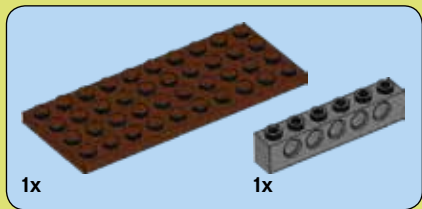
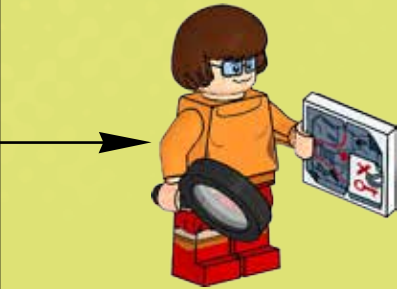
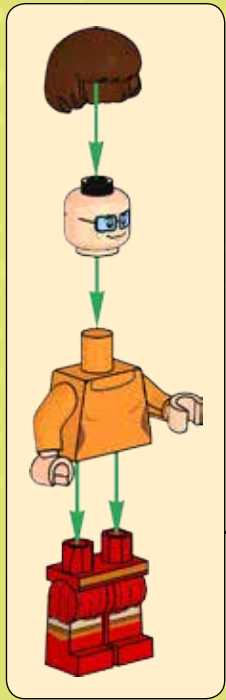
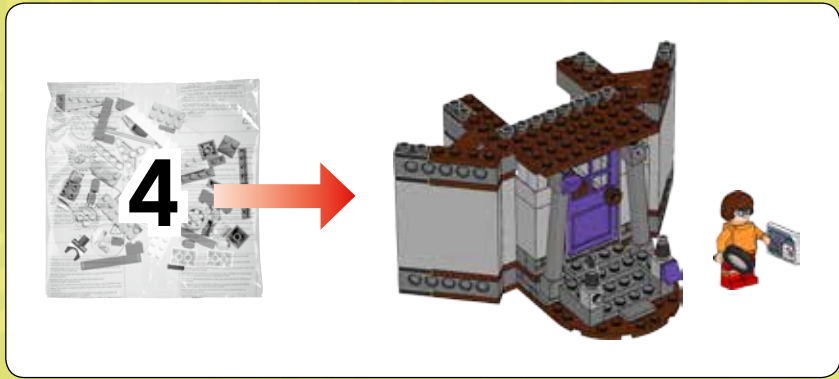

1



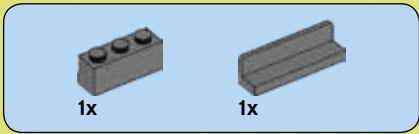

2

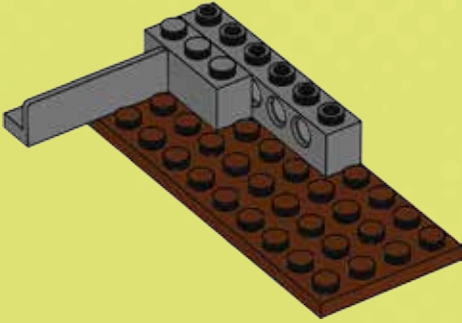

3

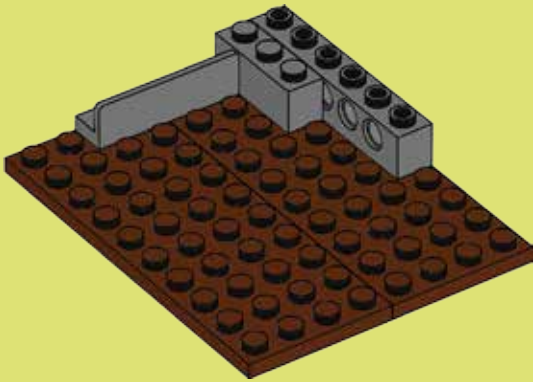

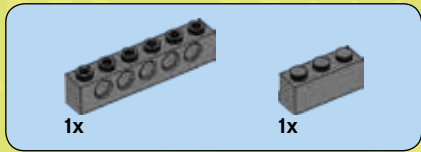

4

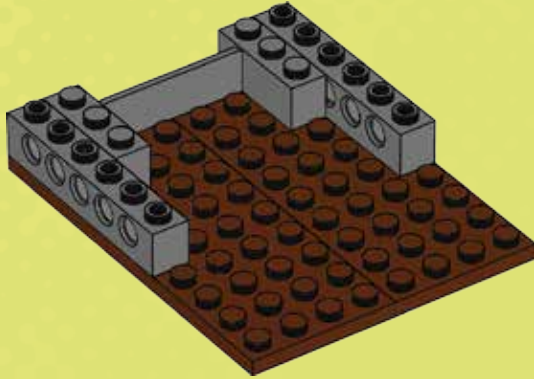

5

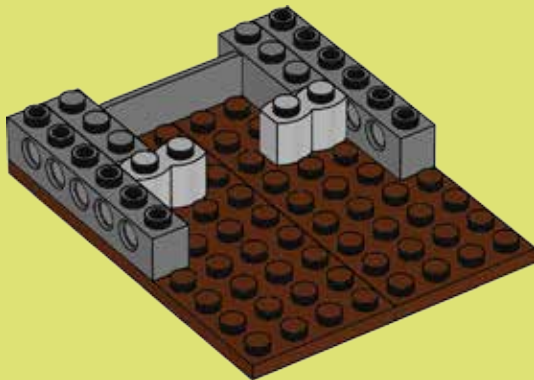

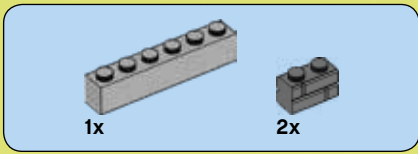

6

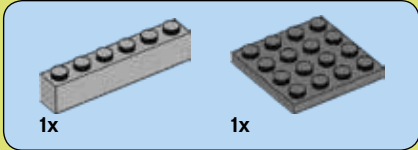
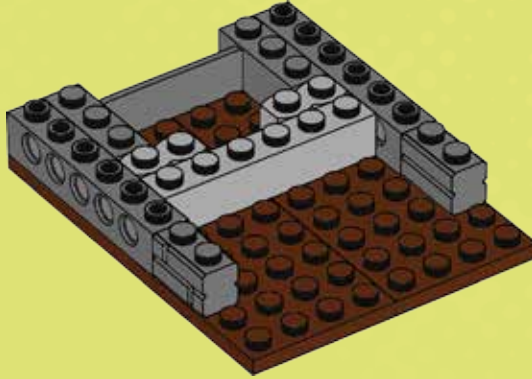

7

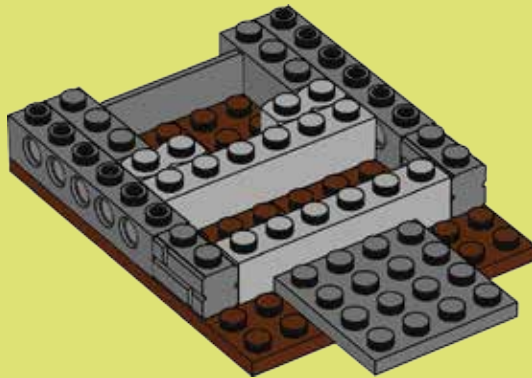



2x

8

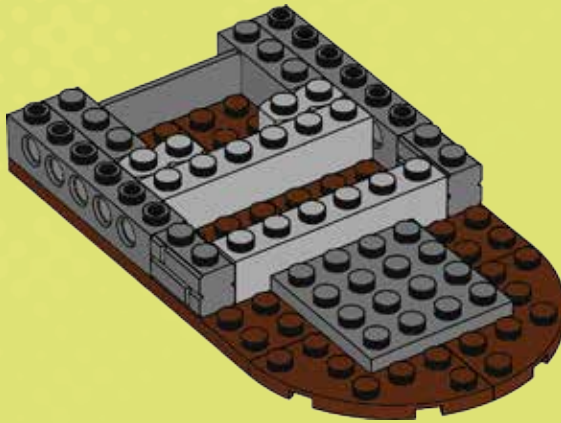

2x



1x



2x

9

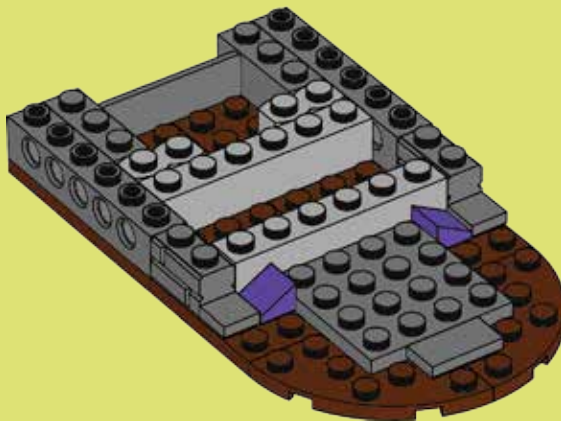

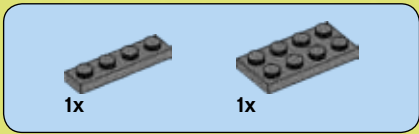

10

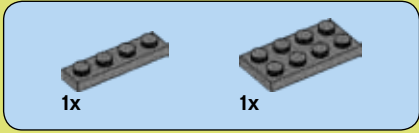
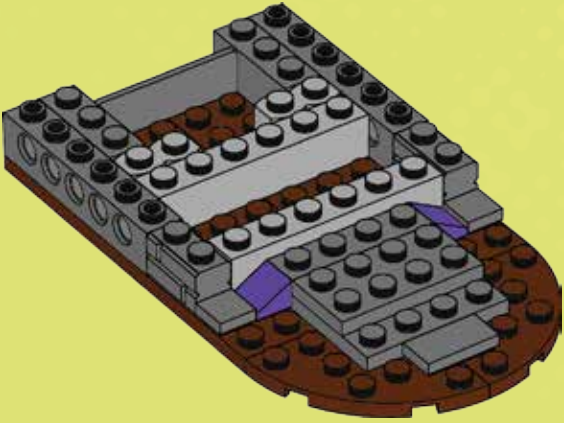

11

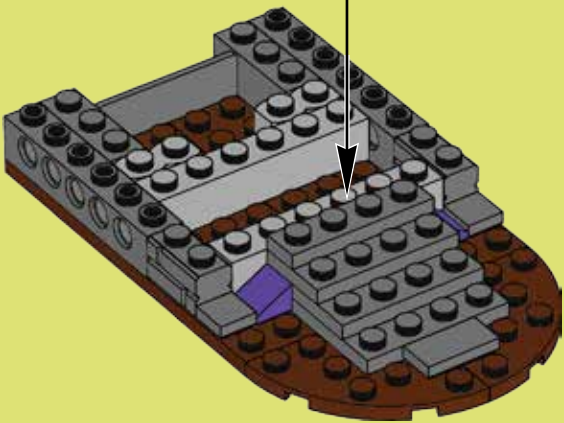
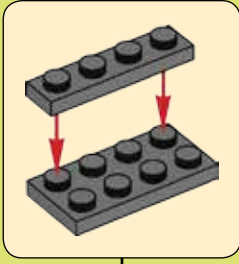



2x

12

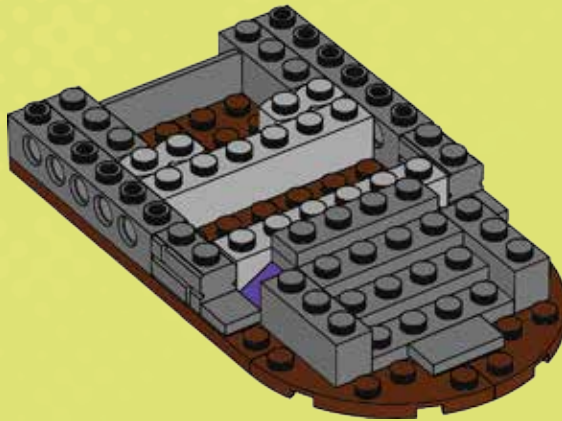

4x

13

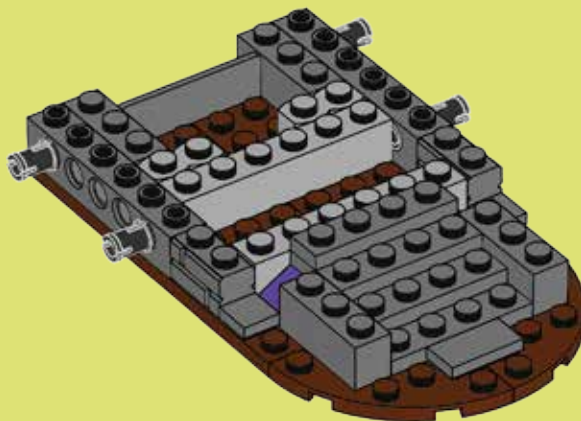

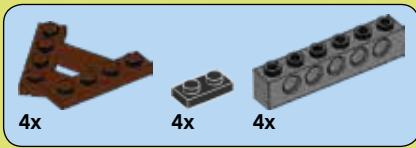

14

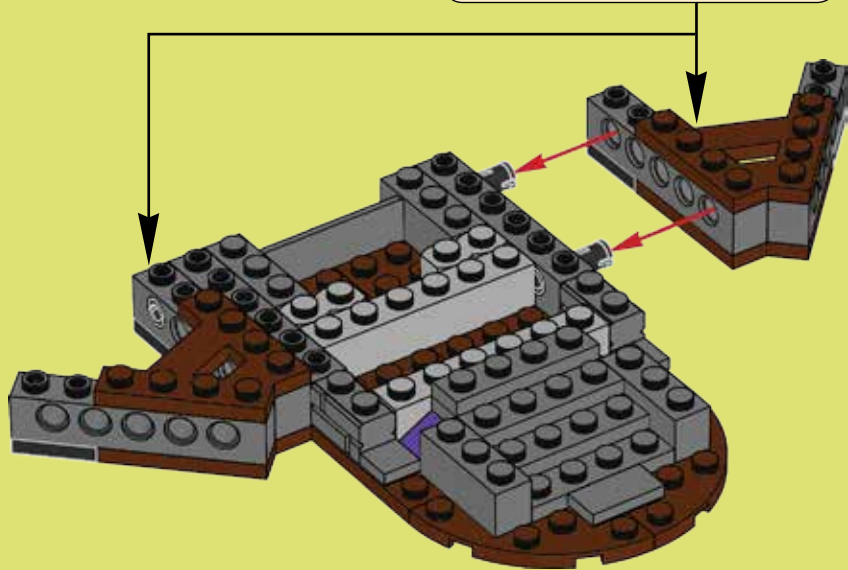
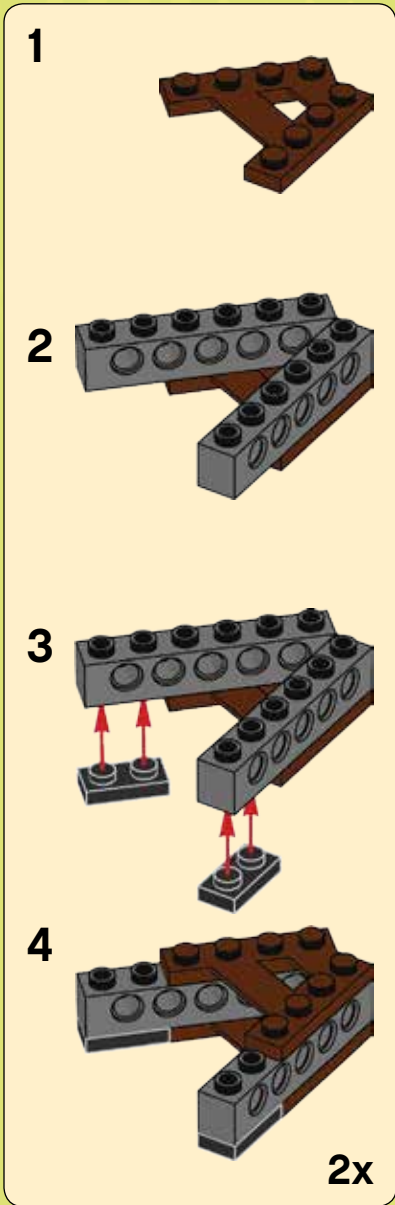

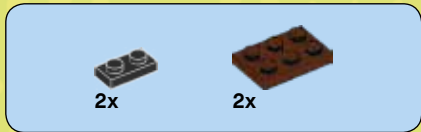

15

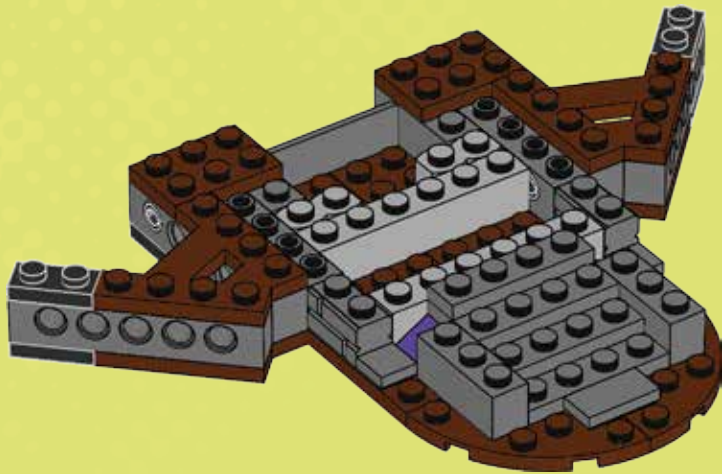

16





17

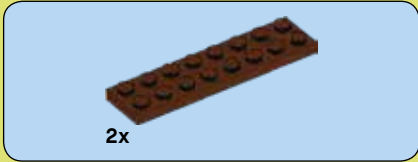
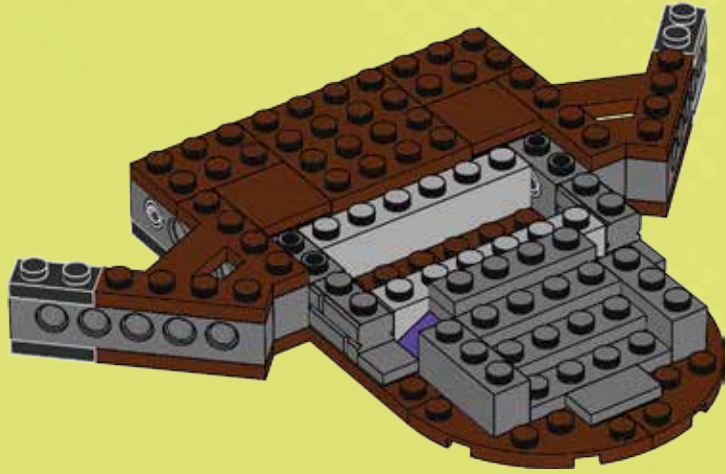

18





4x

19

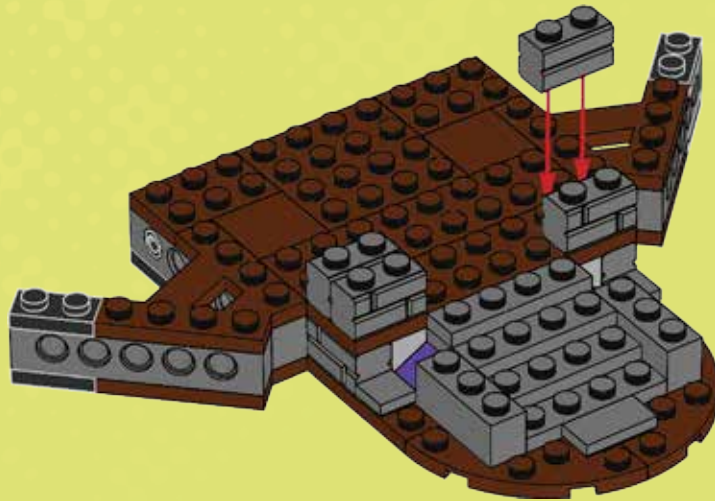

2x

20

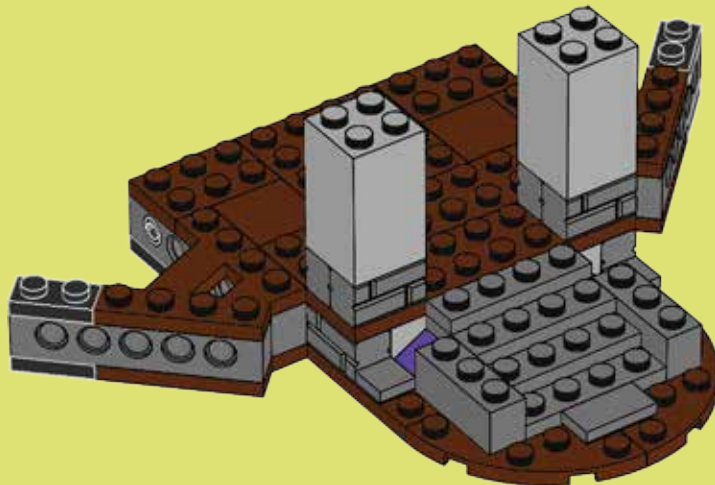



2x



2x

21

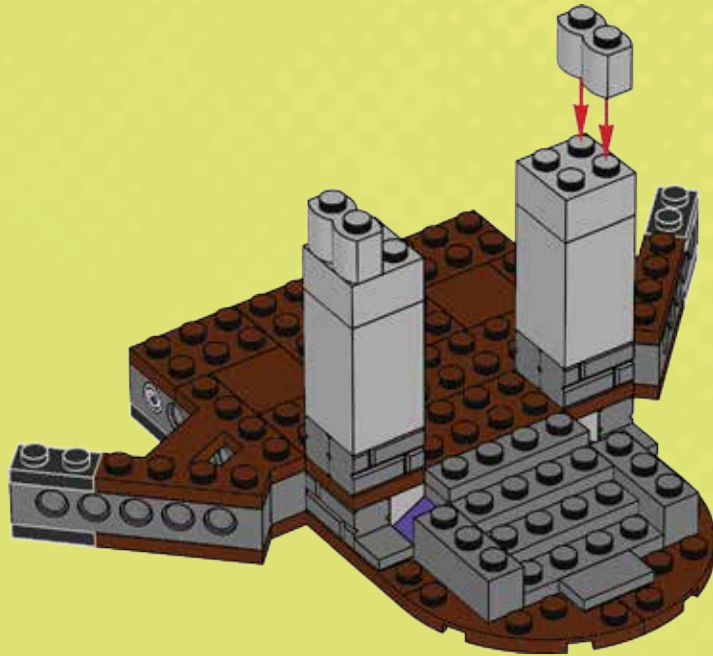

2x



2x

22

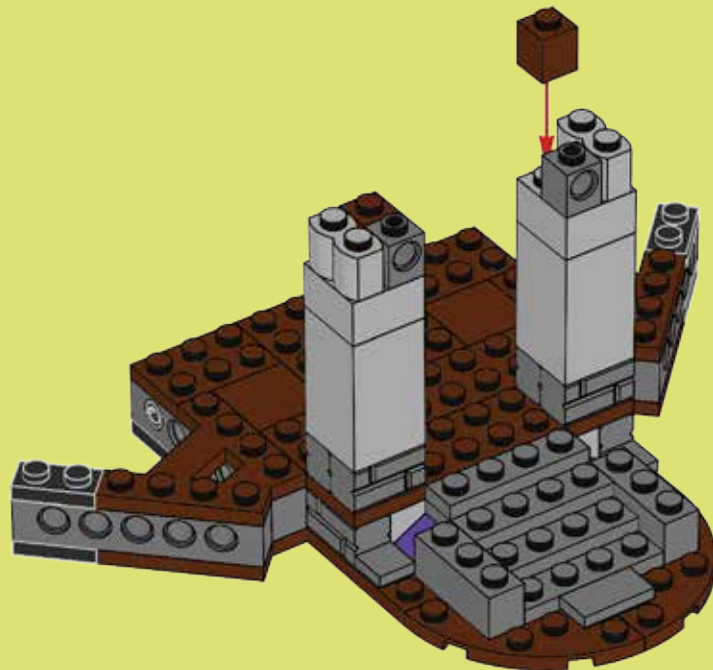

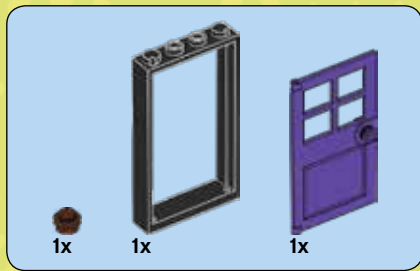

23

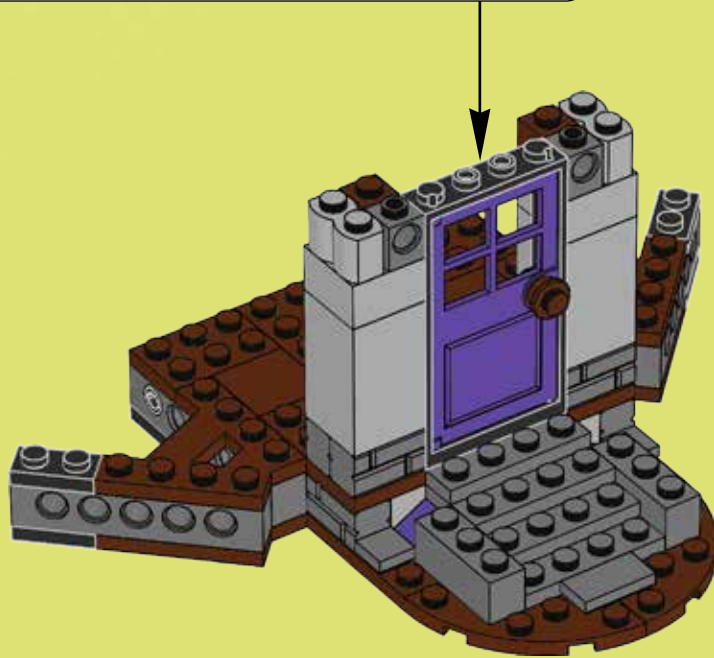
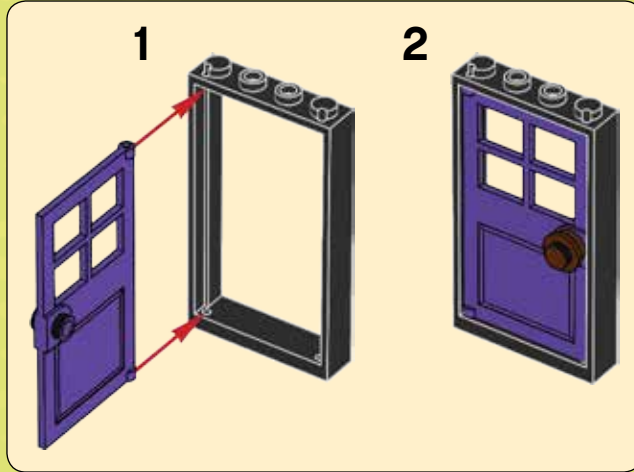

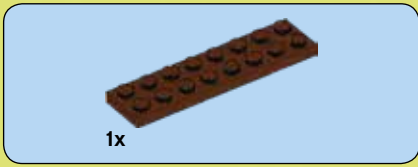

24

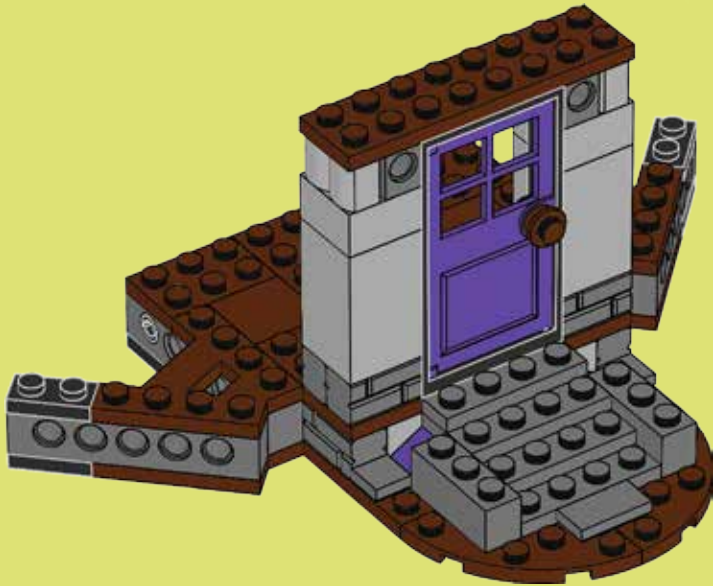

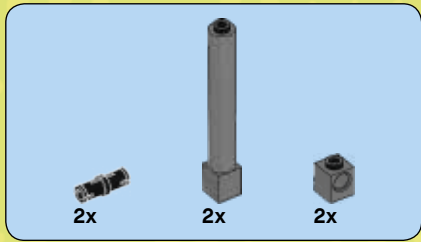

25

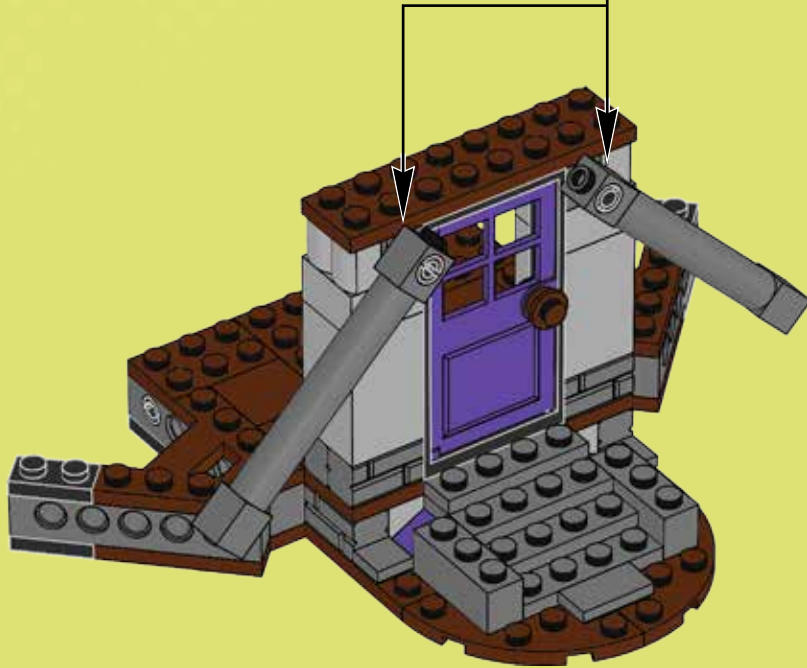
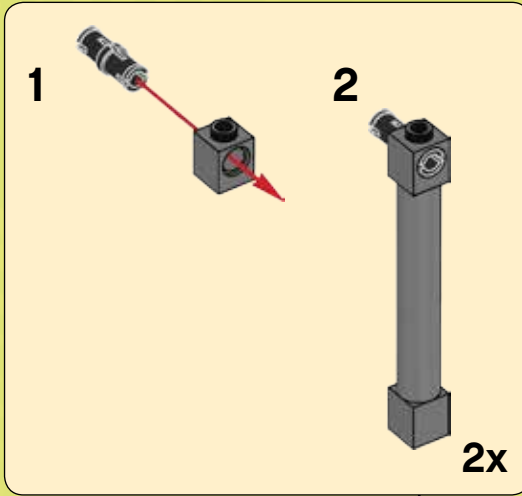

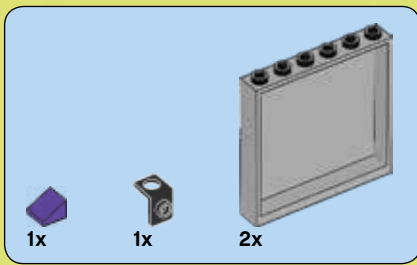

26

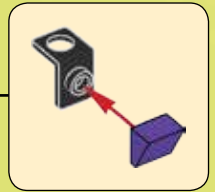
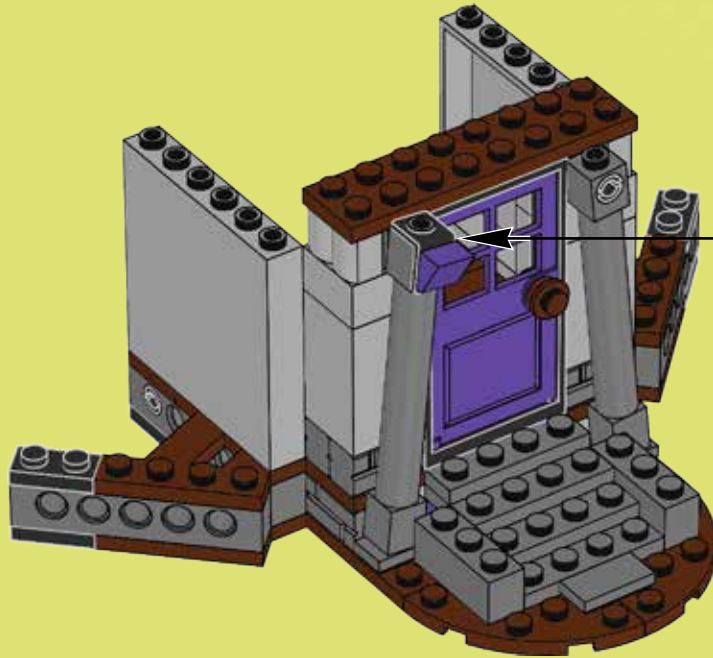

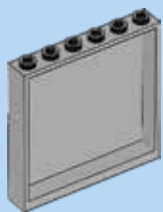

2x

27

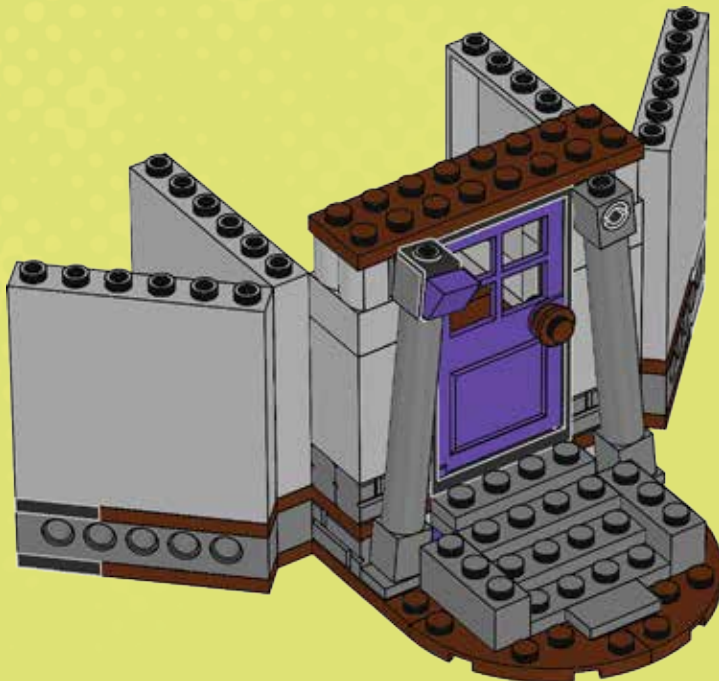

2x

28

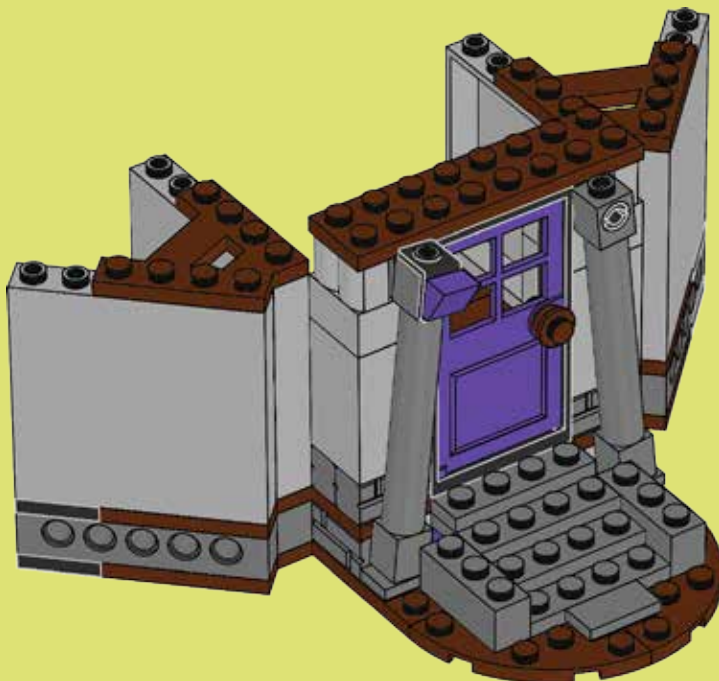



4x

29

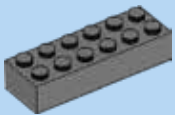
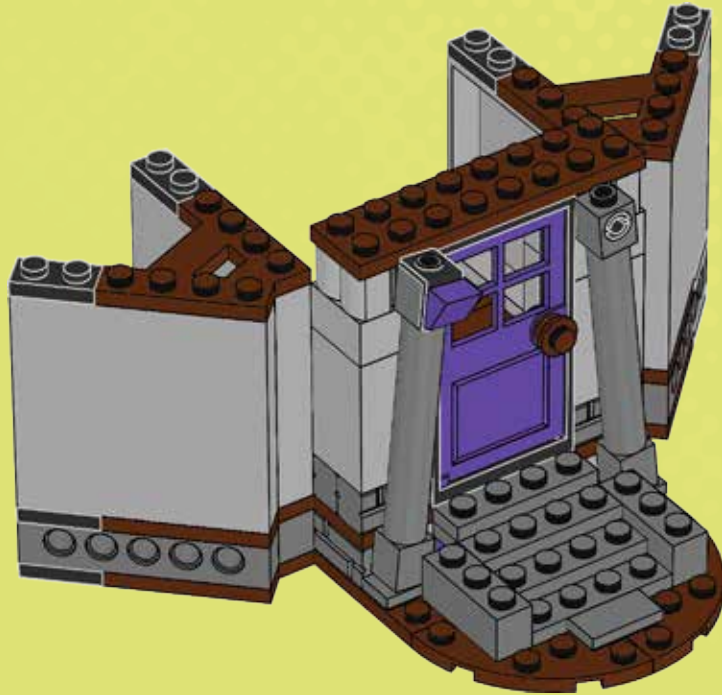

2x



2x

30

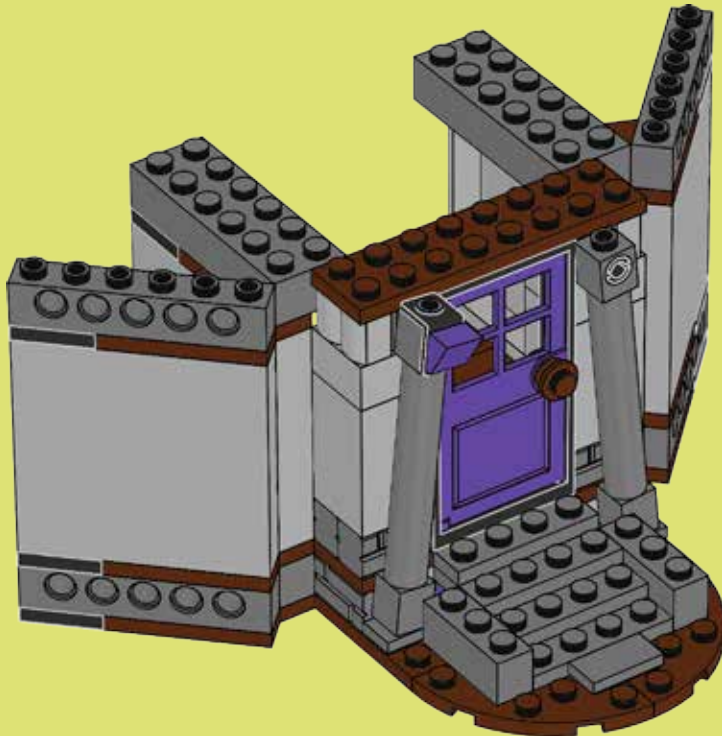



2x

31

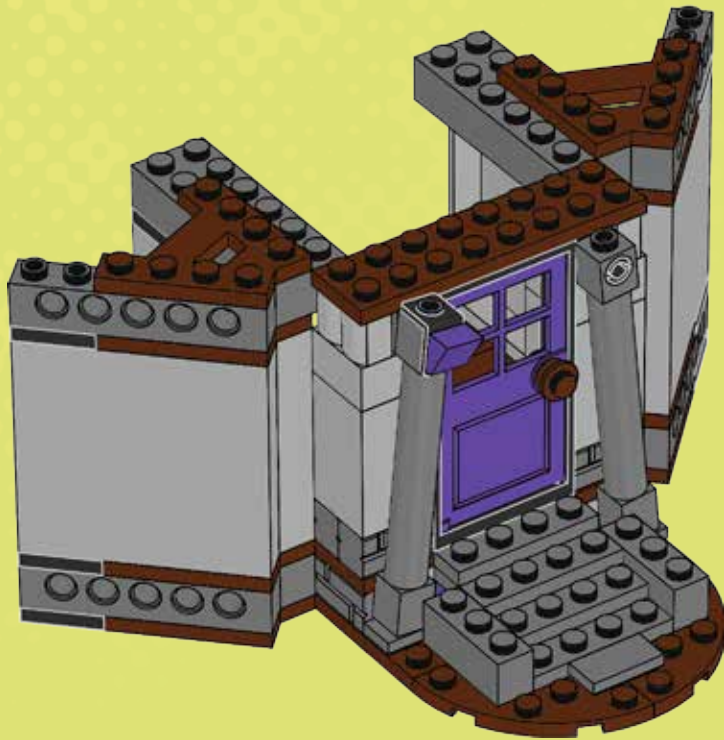

4x

32

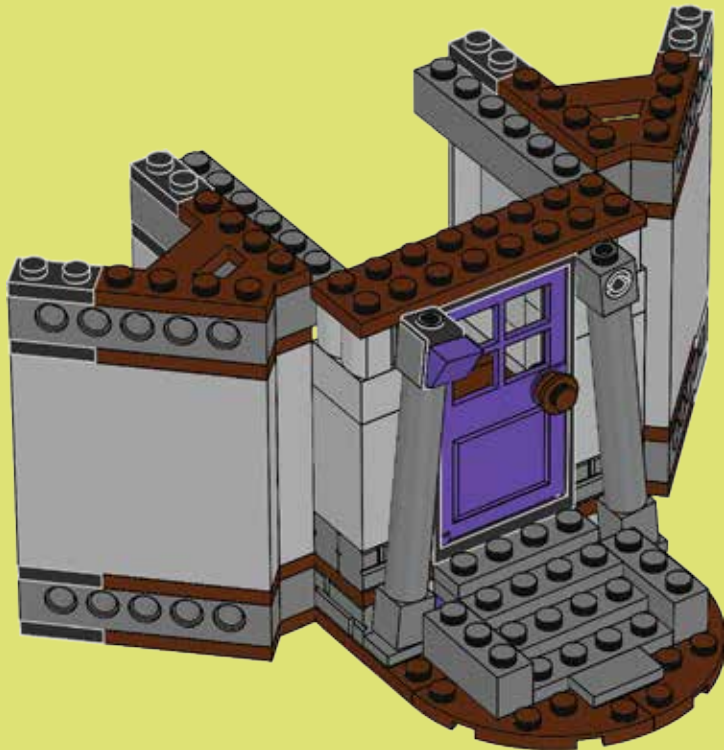

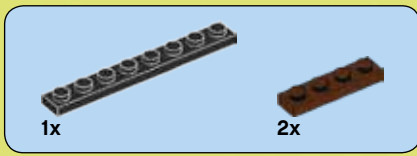

33

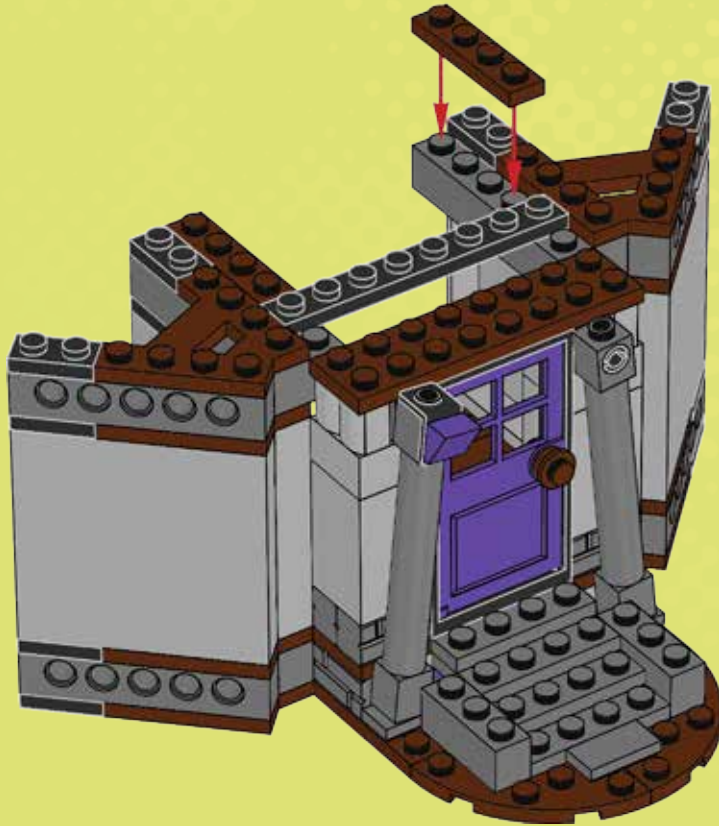

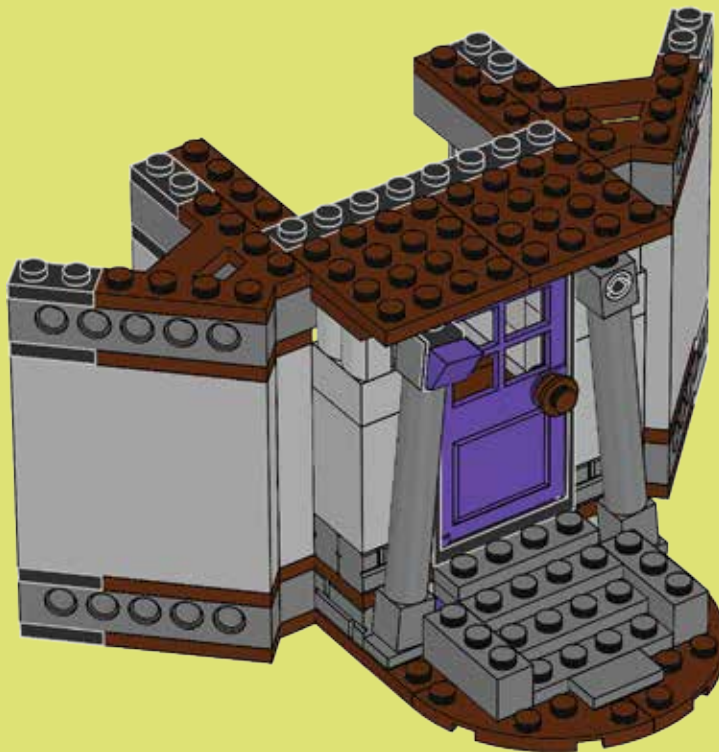

34

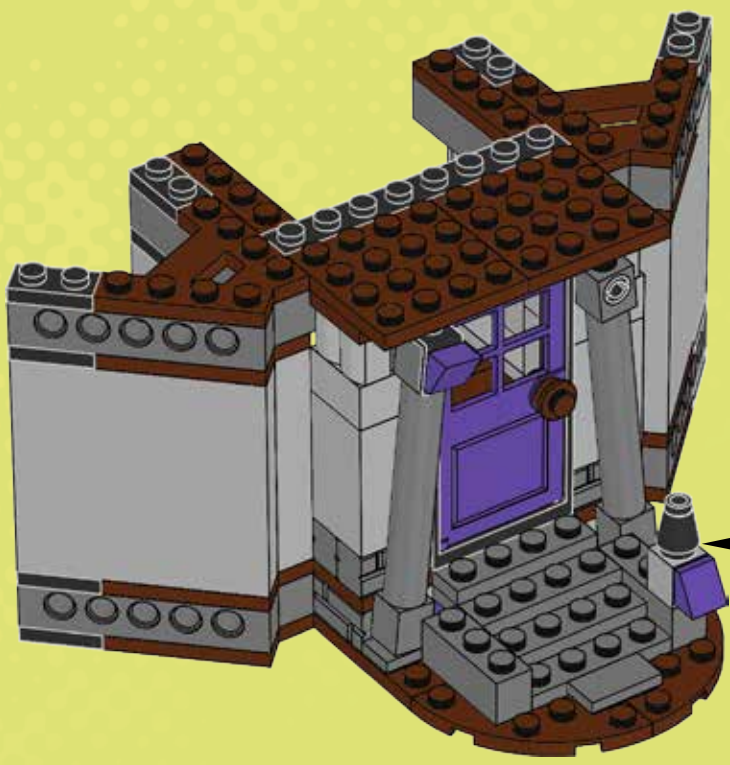

- 1x 
- 1x 
- 1x 

35





- 1 
- 2 

- 1x 
- 1x 
- 1x 

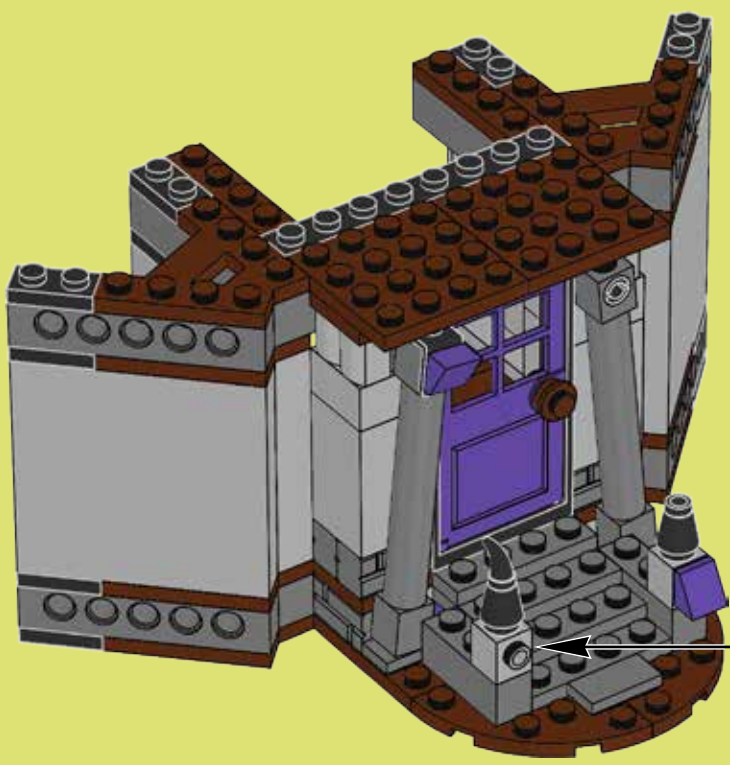
36



- 1 
- 2 

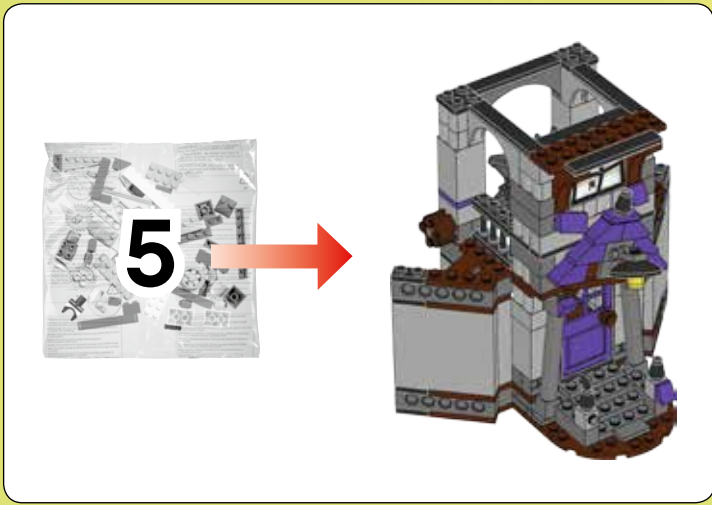

37

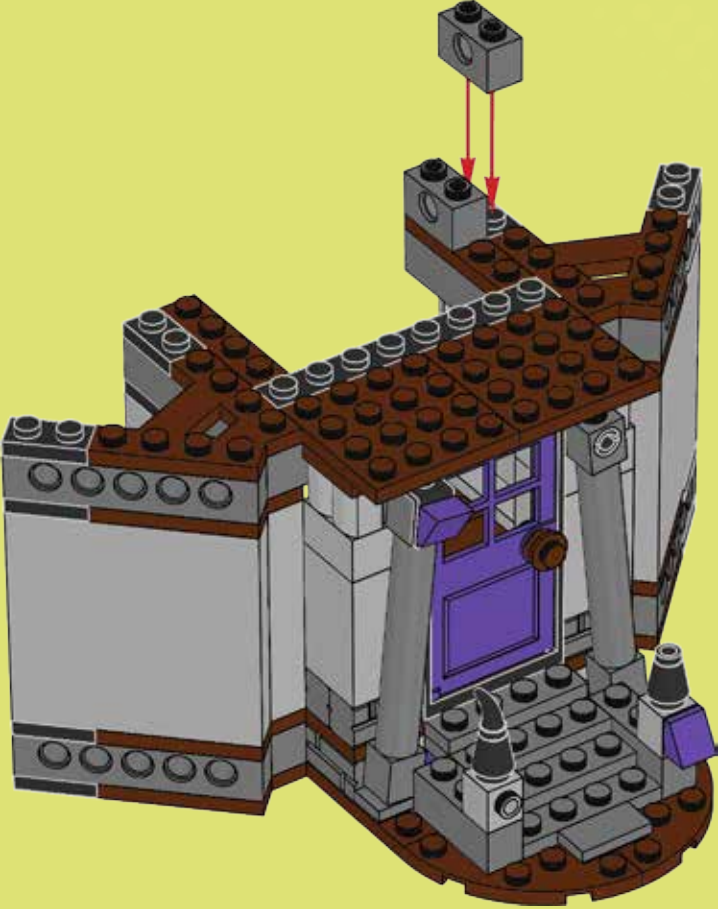

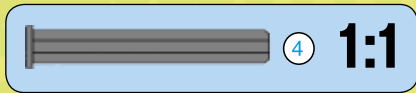

38

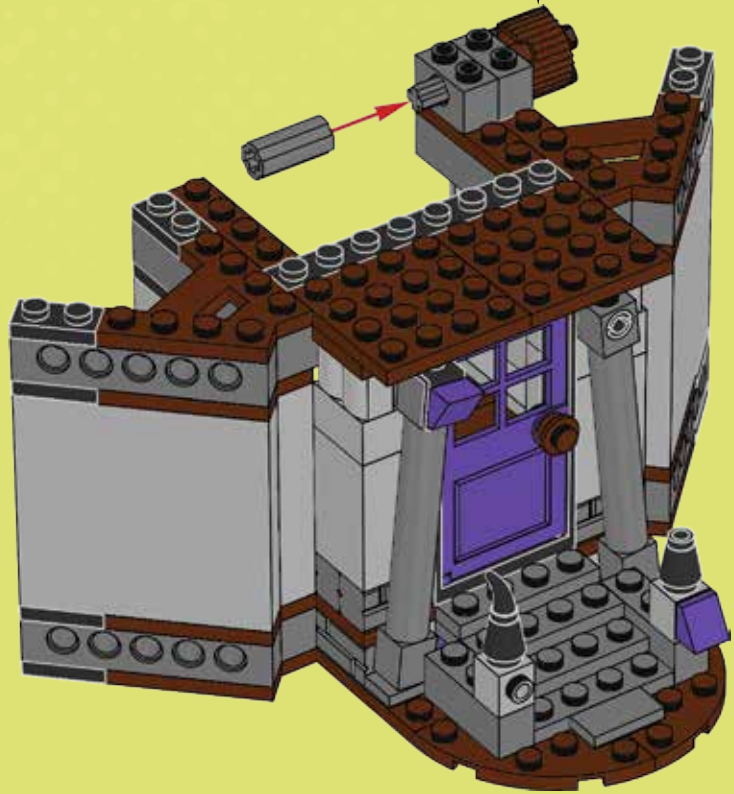
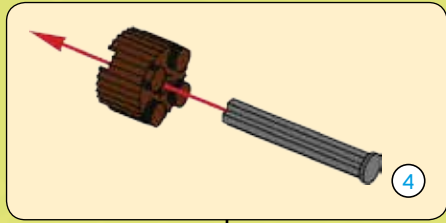

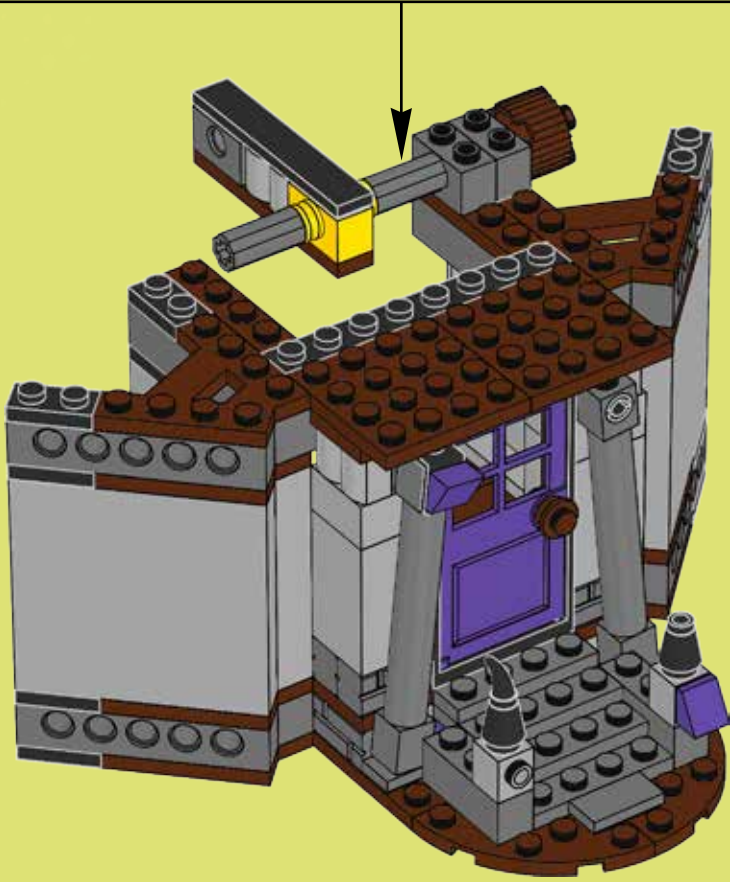
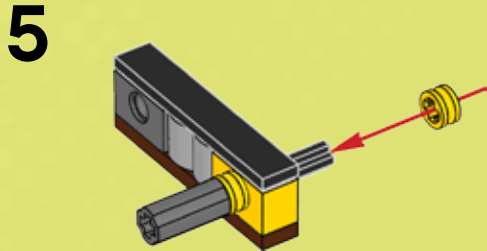
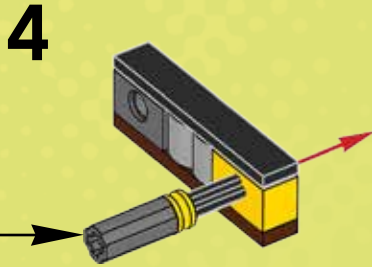
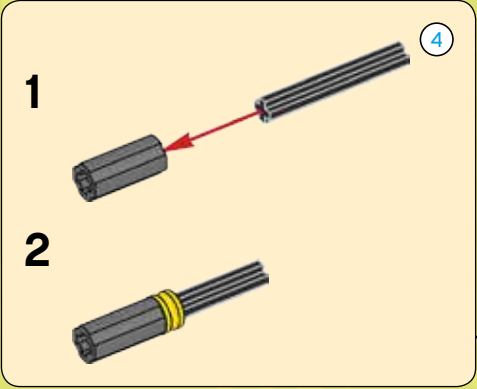



2x

40

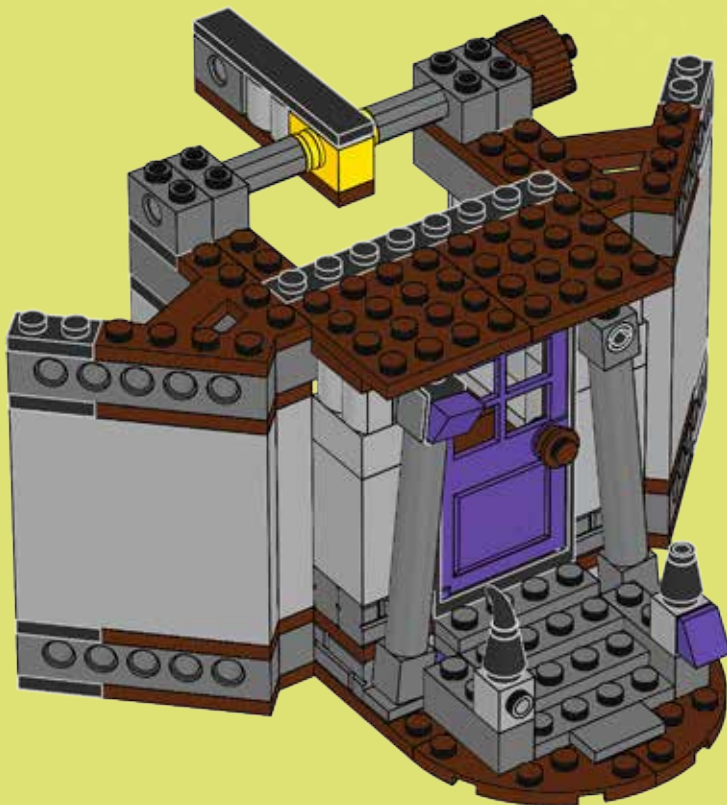

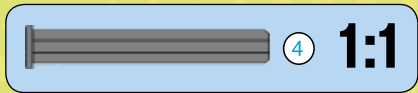
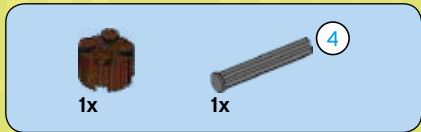

41

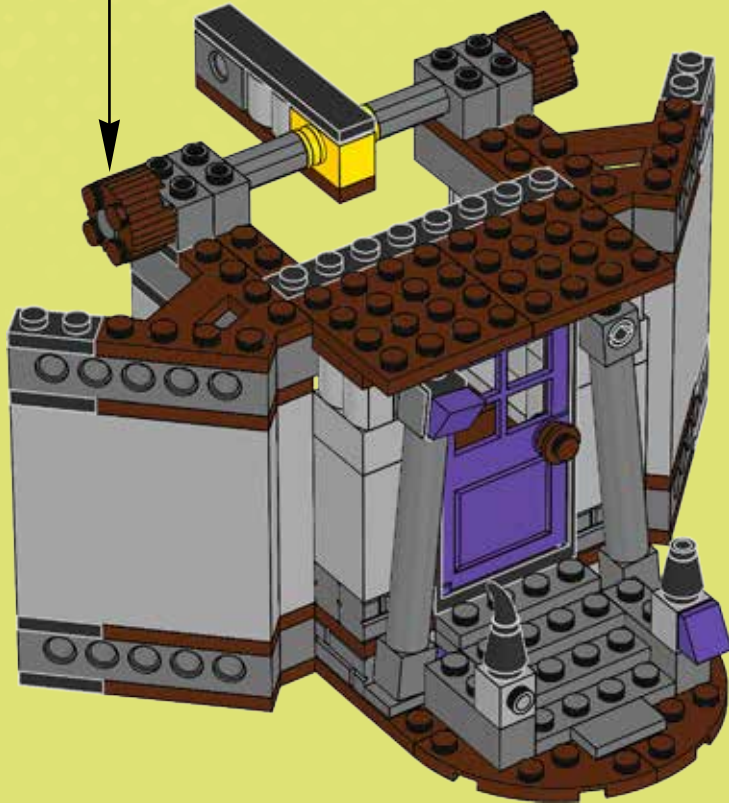
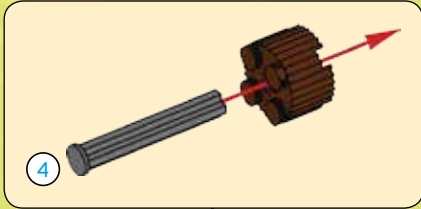

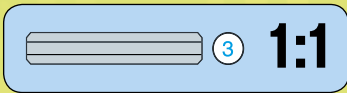
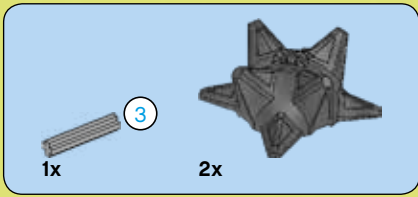

42

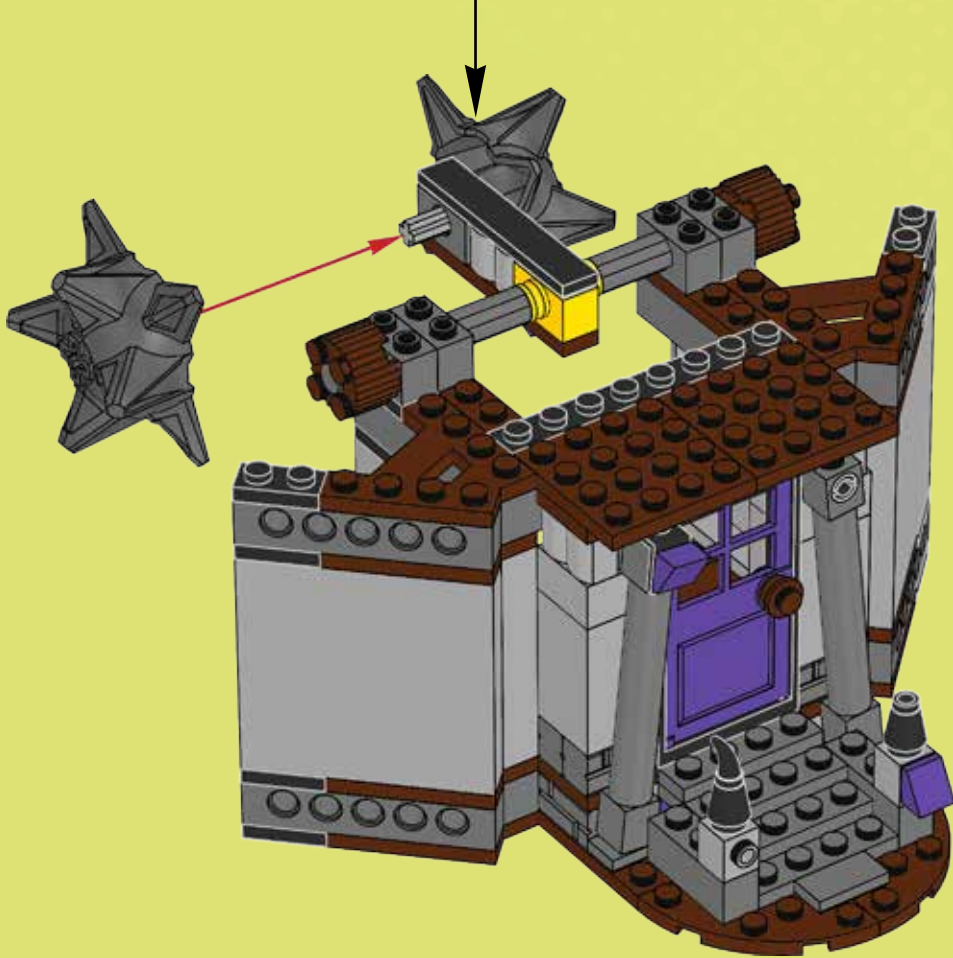
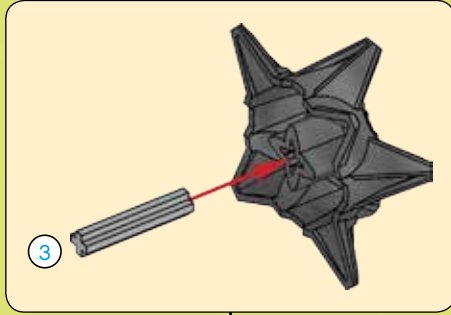

43

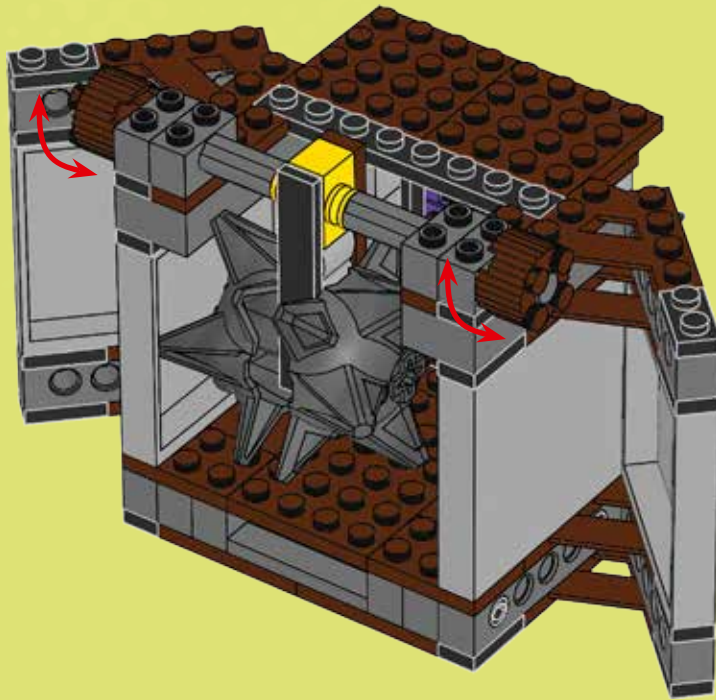

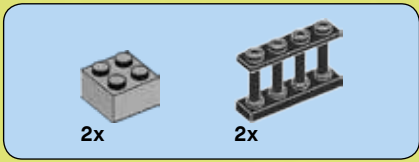

44

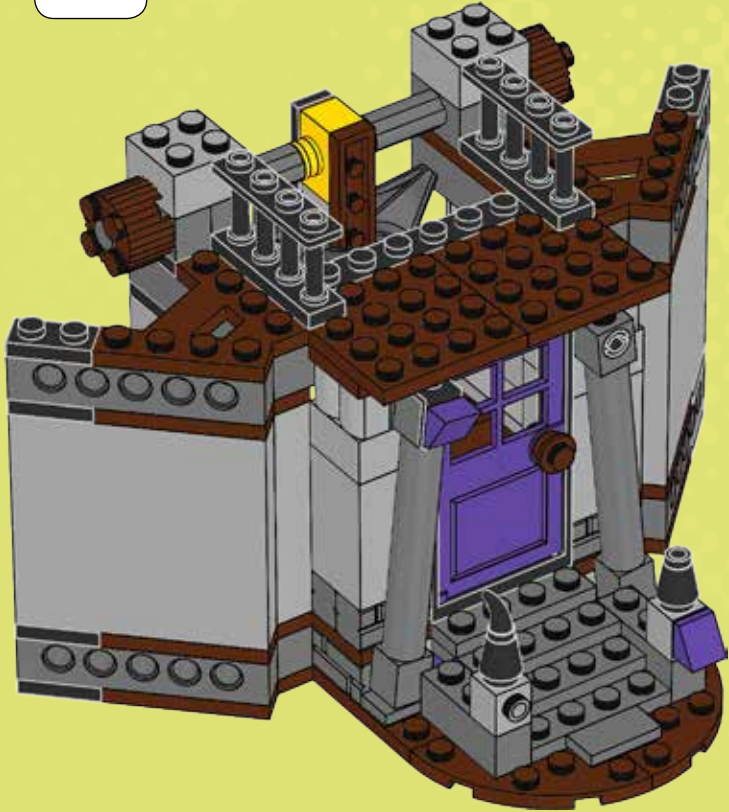

45

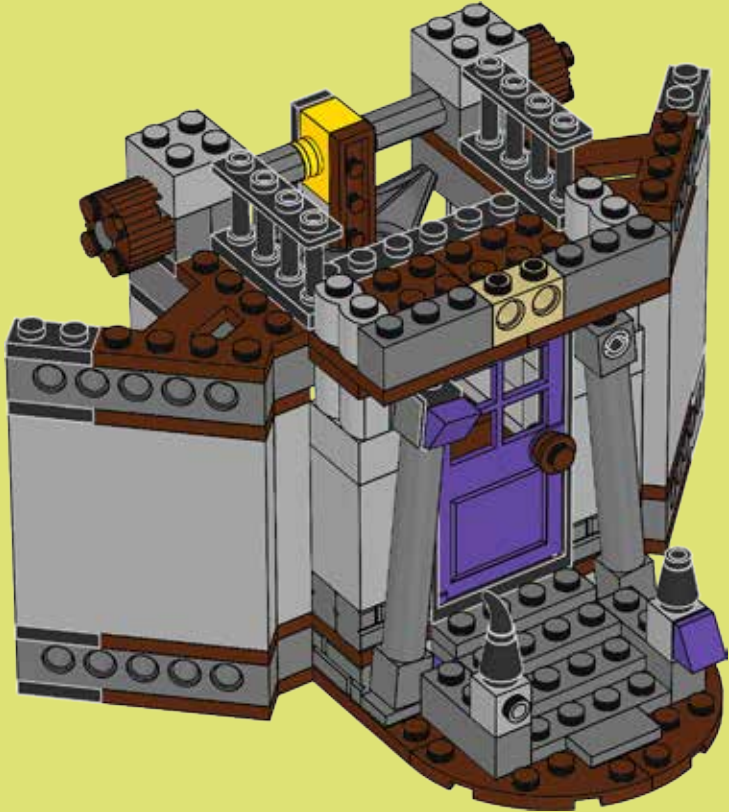

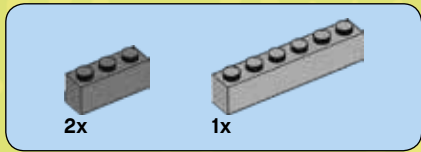

46

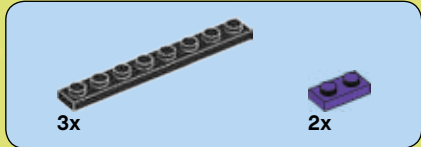
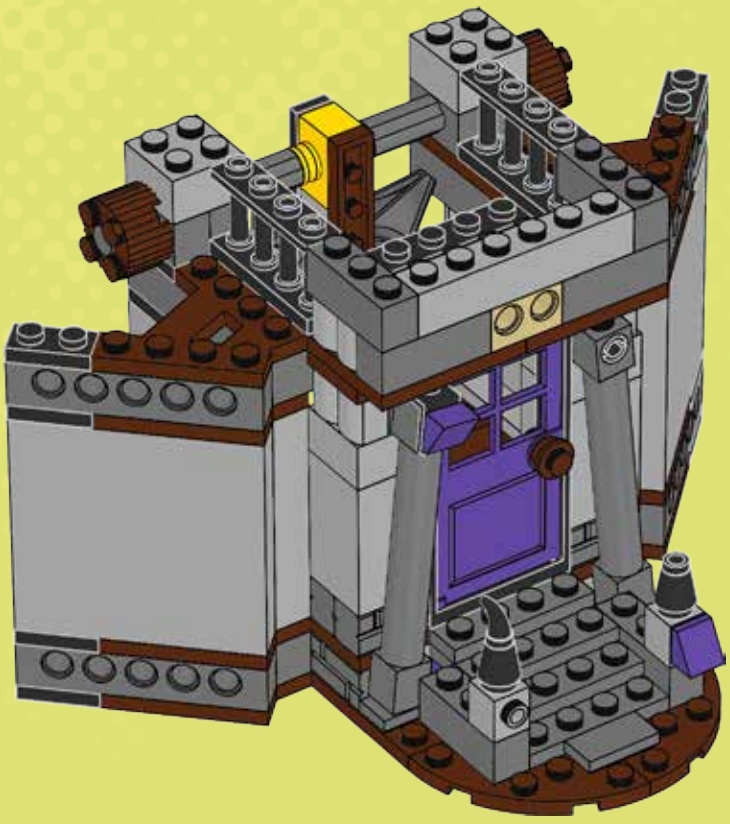

47

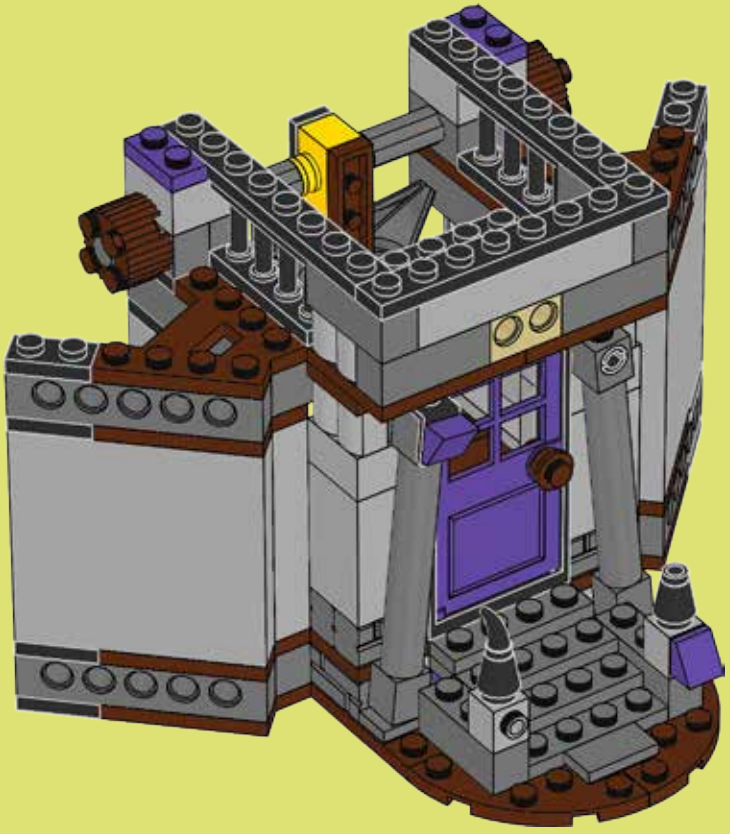

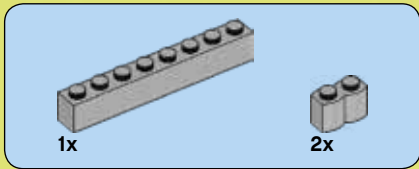

48

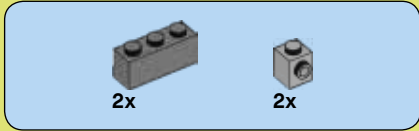
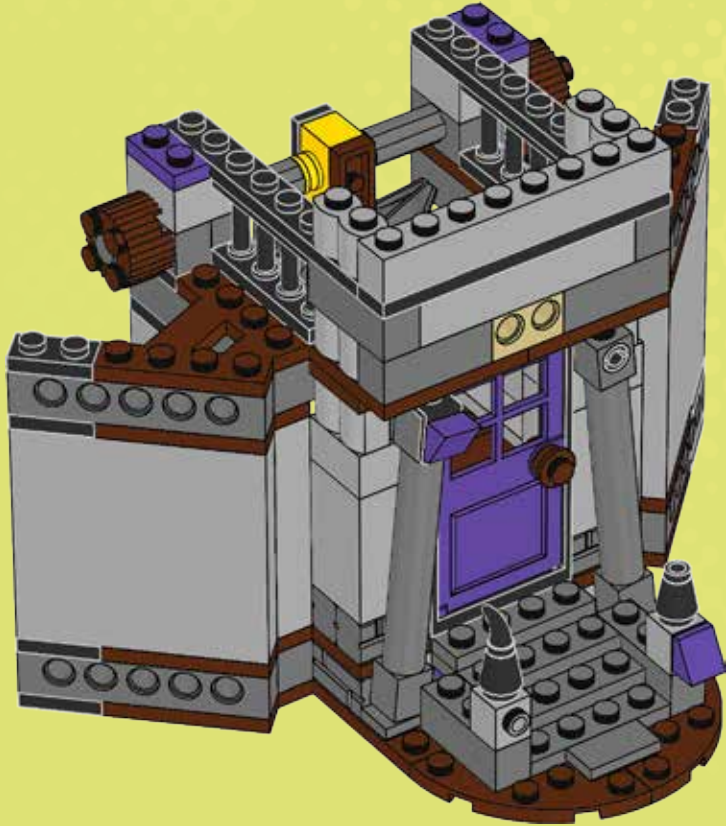

49

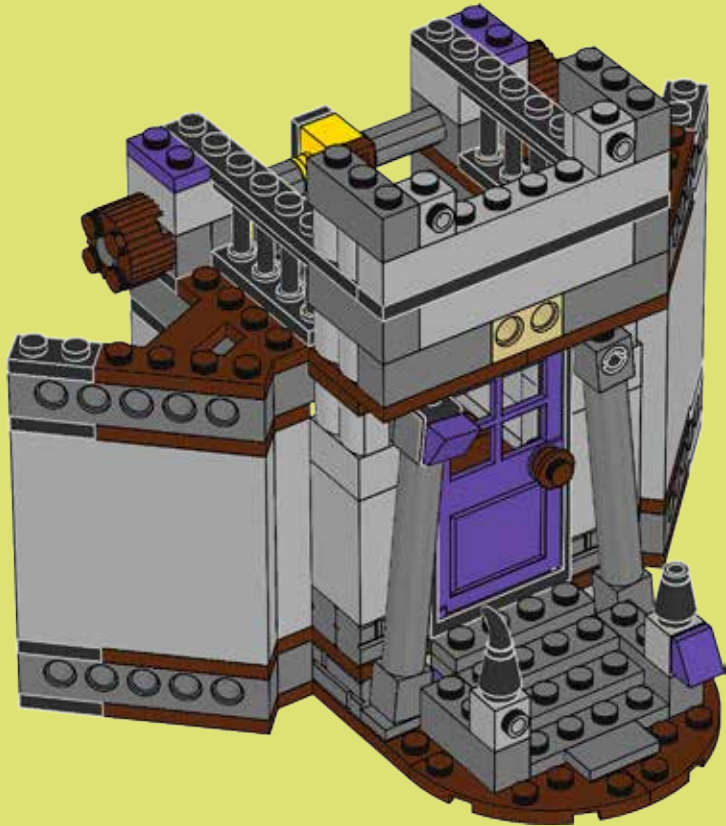



1x



2x

50

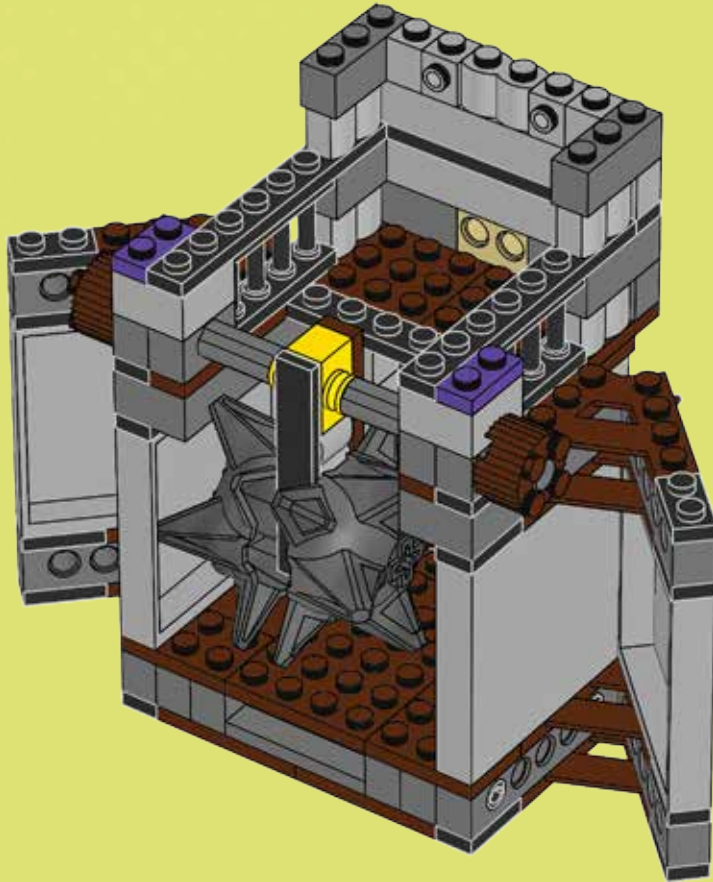

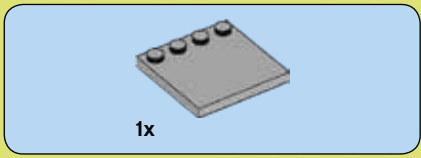

51

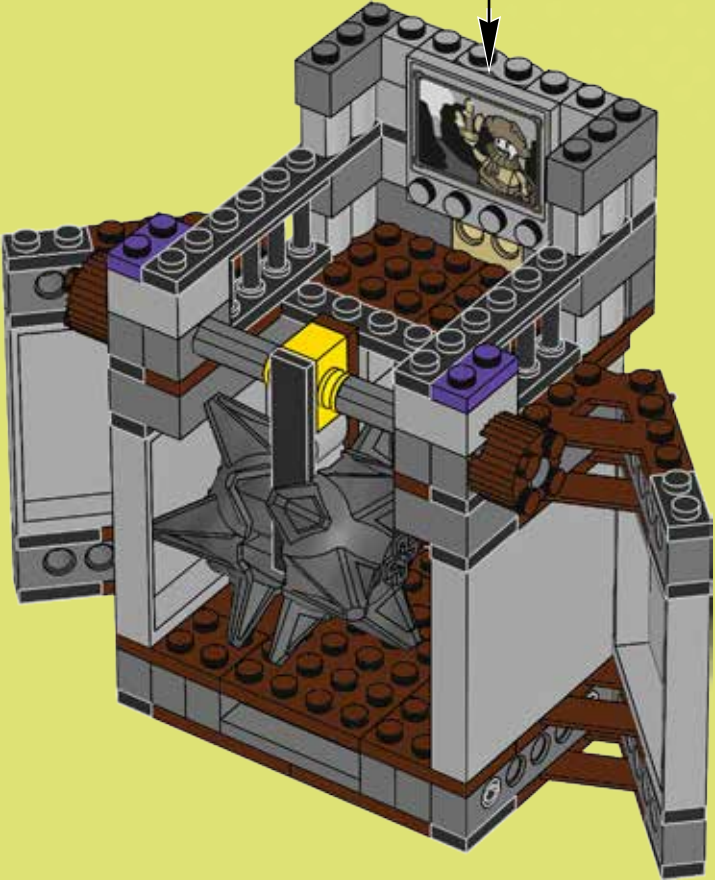
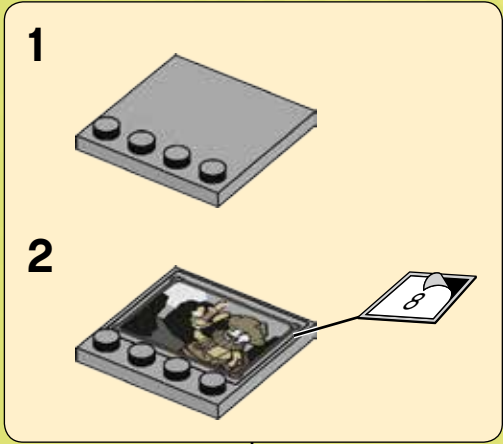

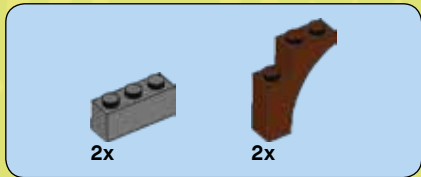

52

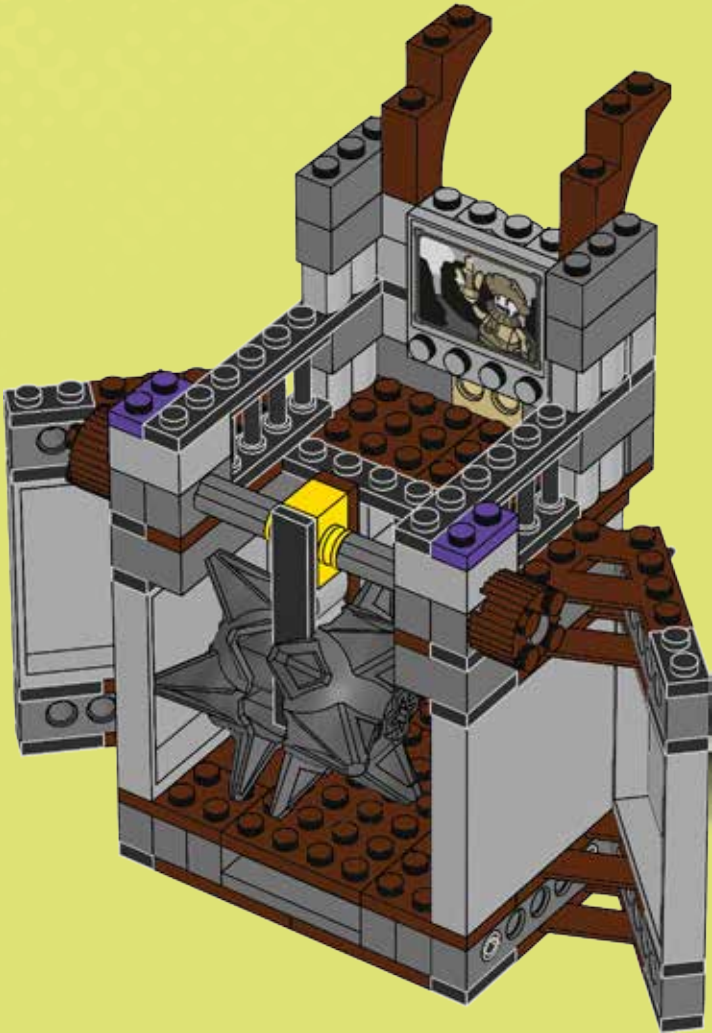

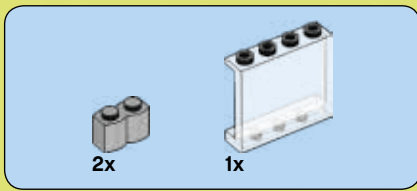

53

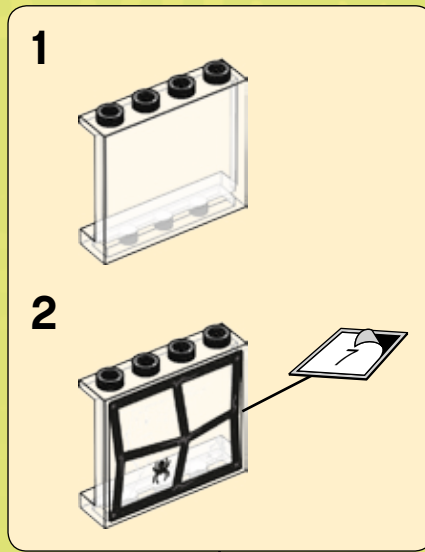

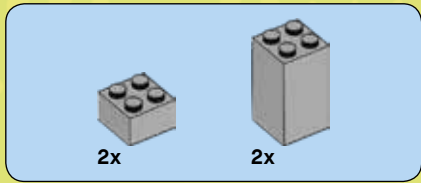

54



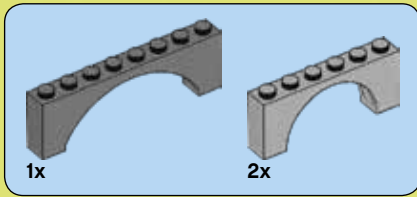

55

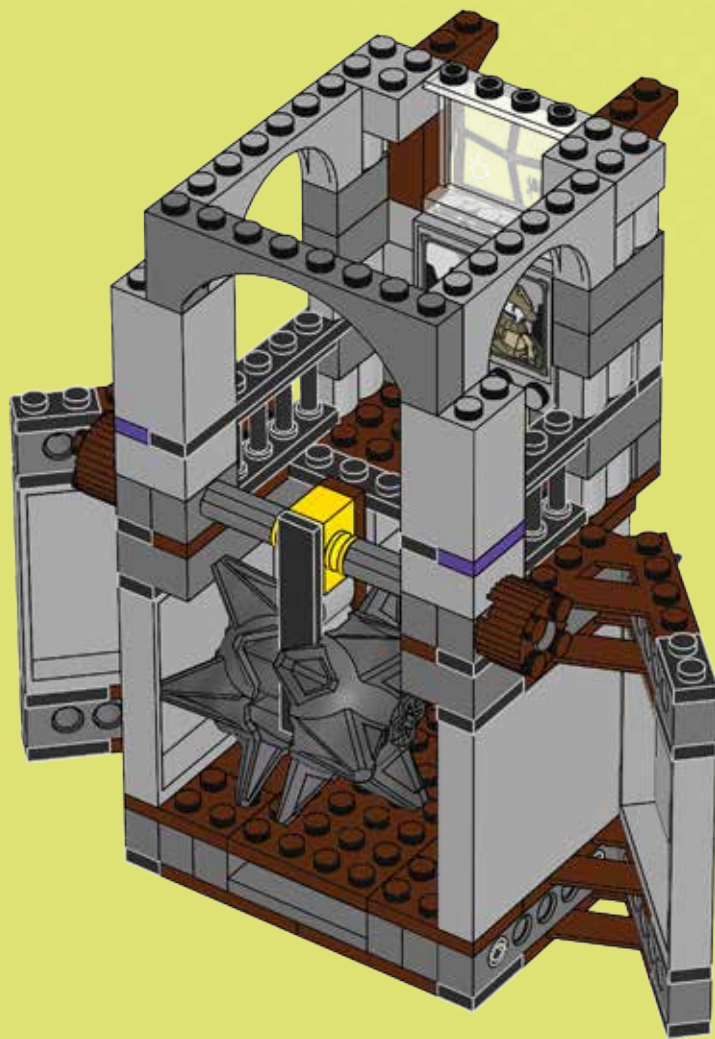



4x

56

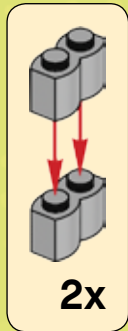

2x

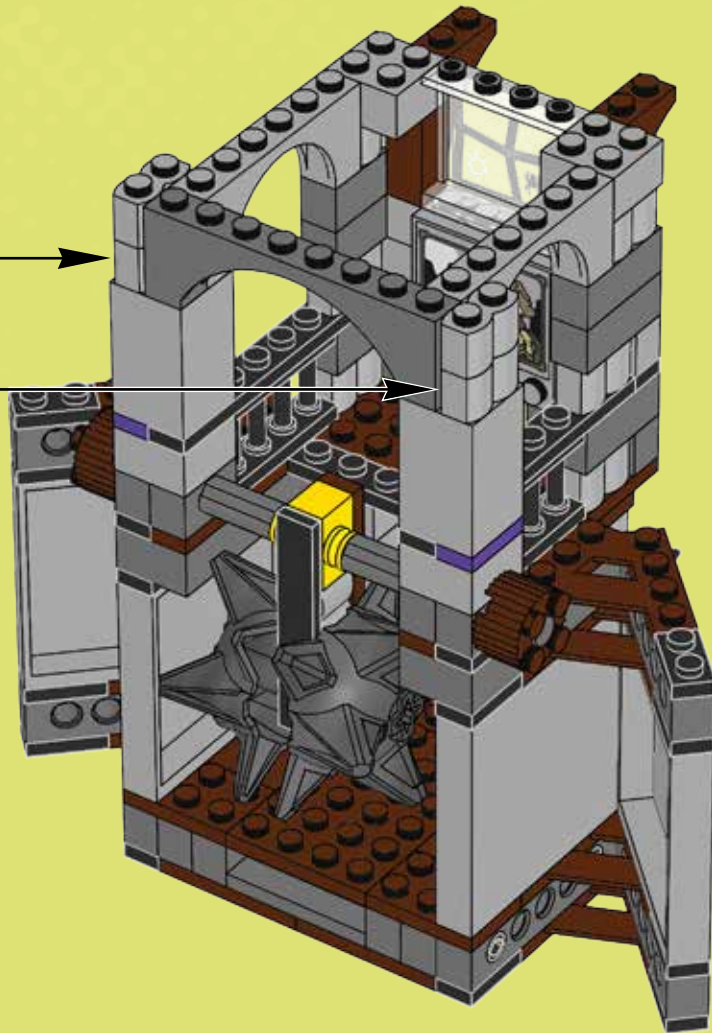

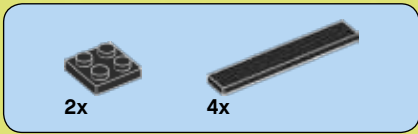

57

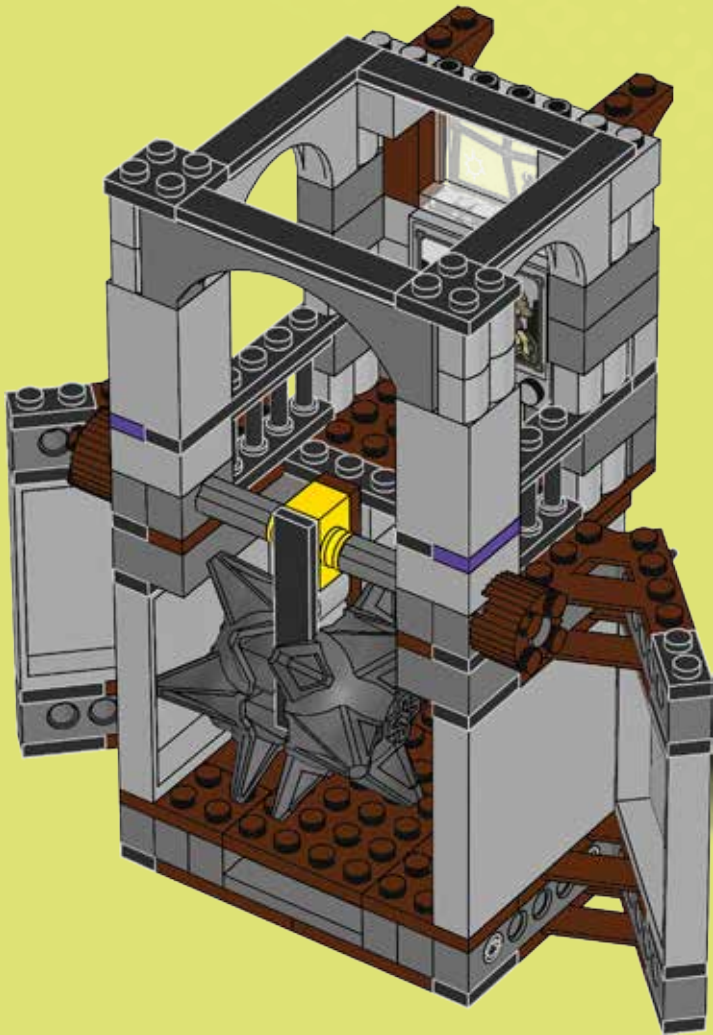

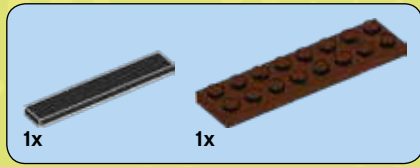

58

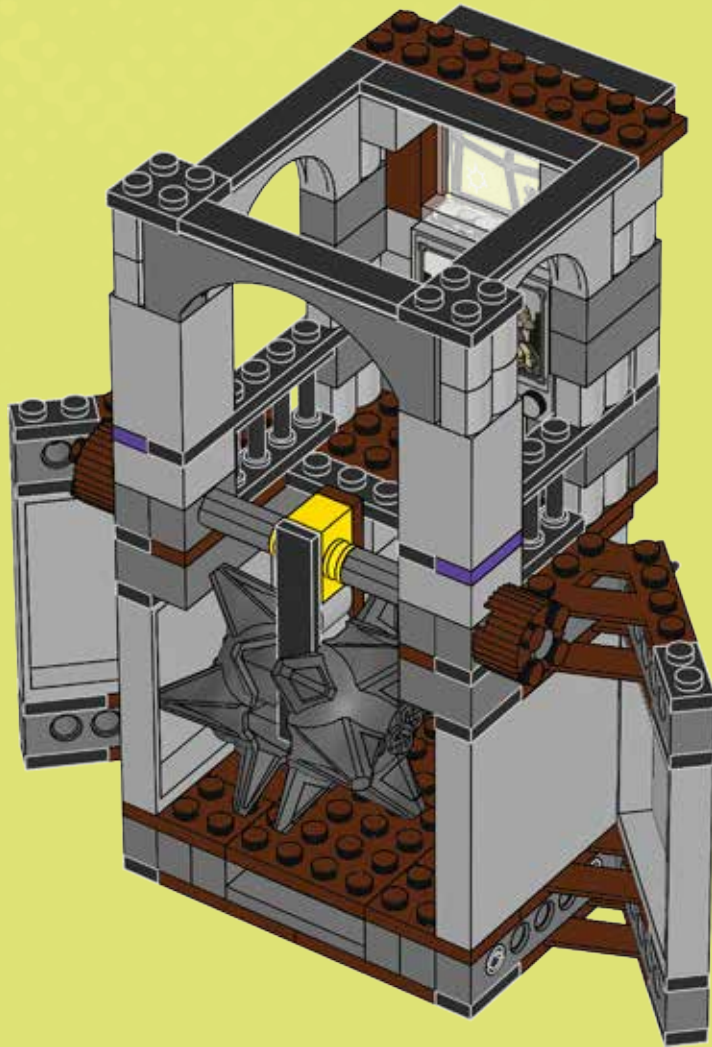



59

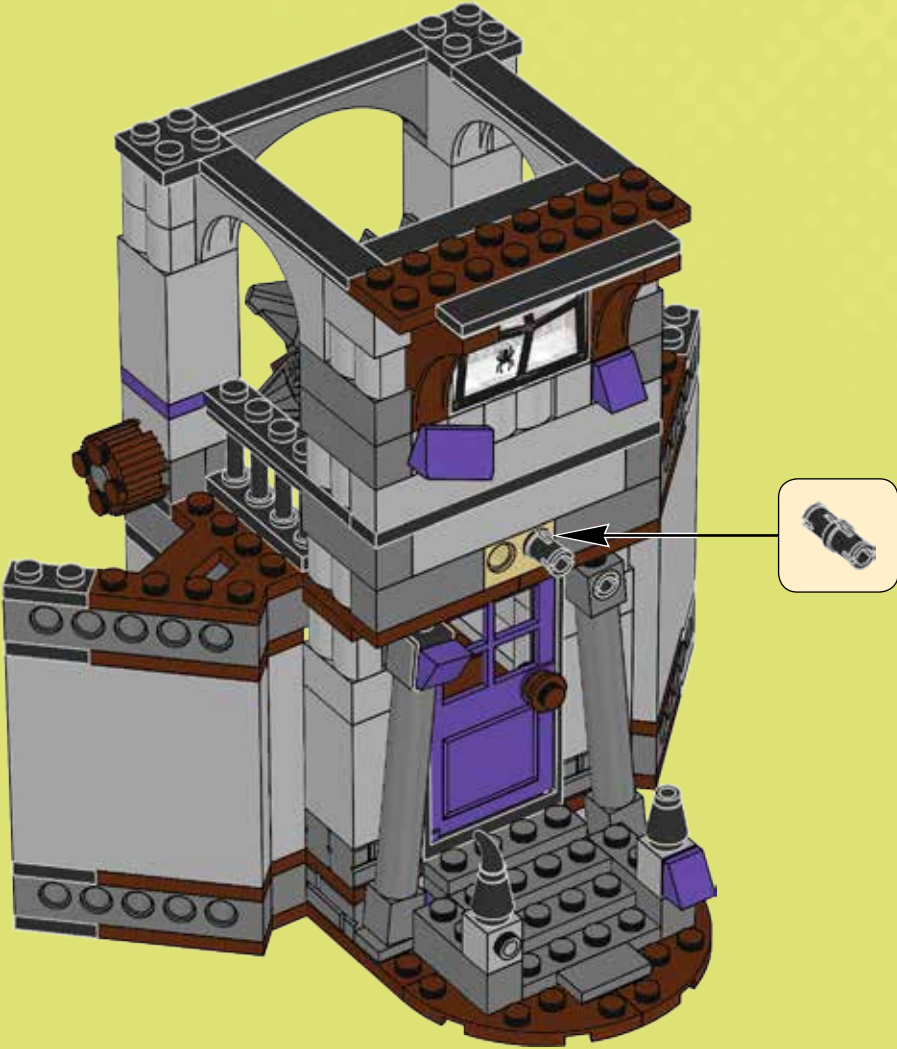



1

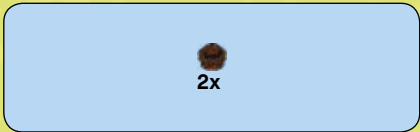

2



3

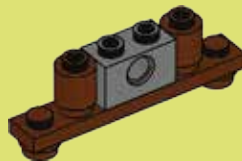

4

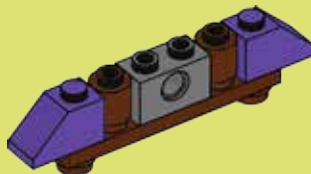



1x



2x

5

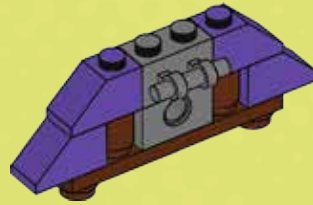

2x

6

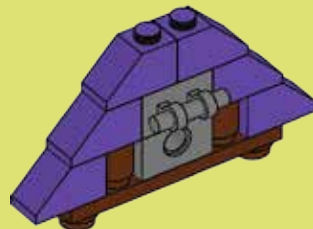

1x



1x

7

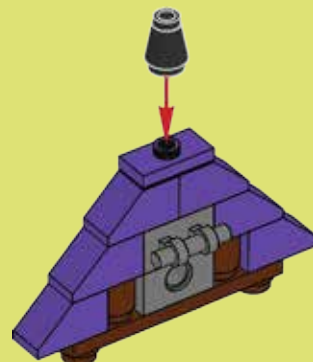



8

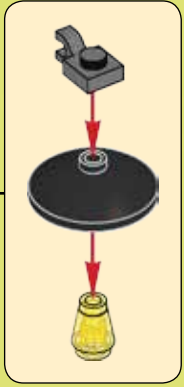
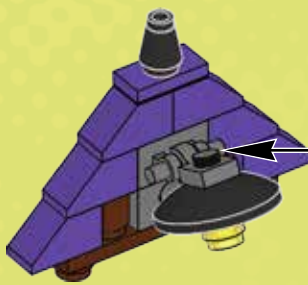

60

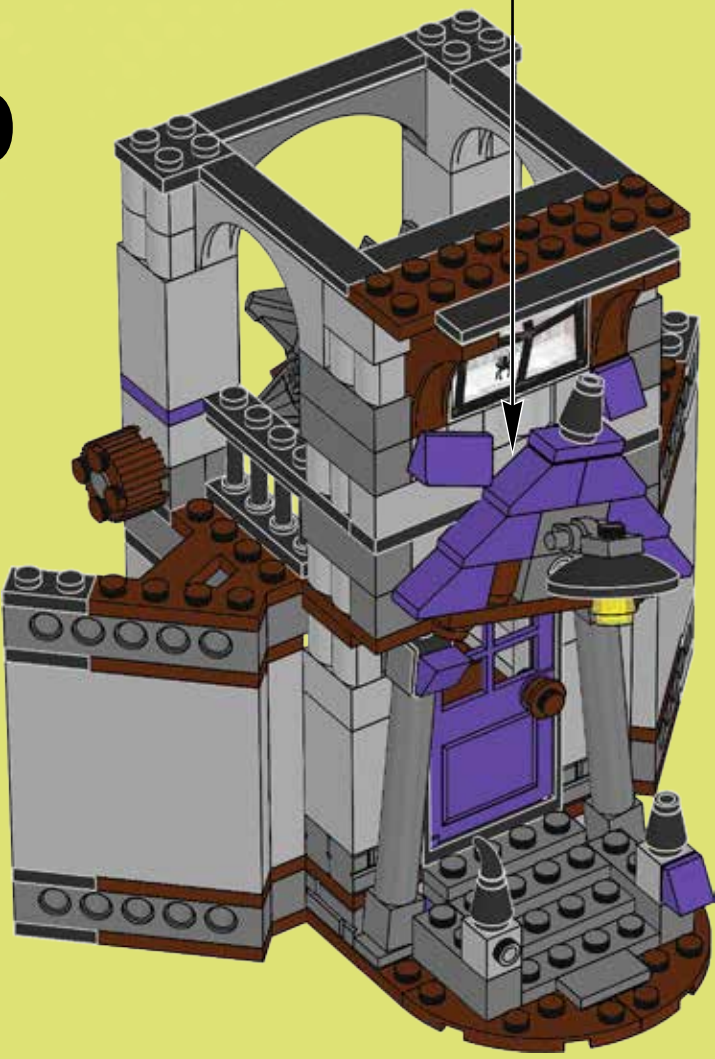

61

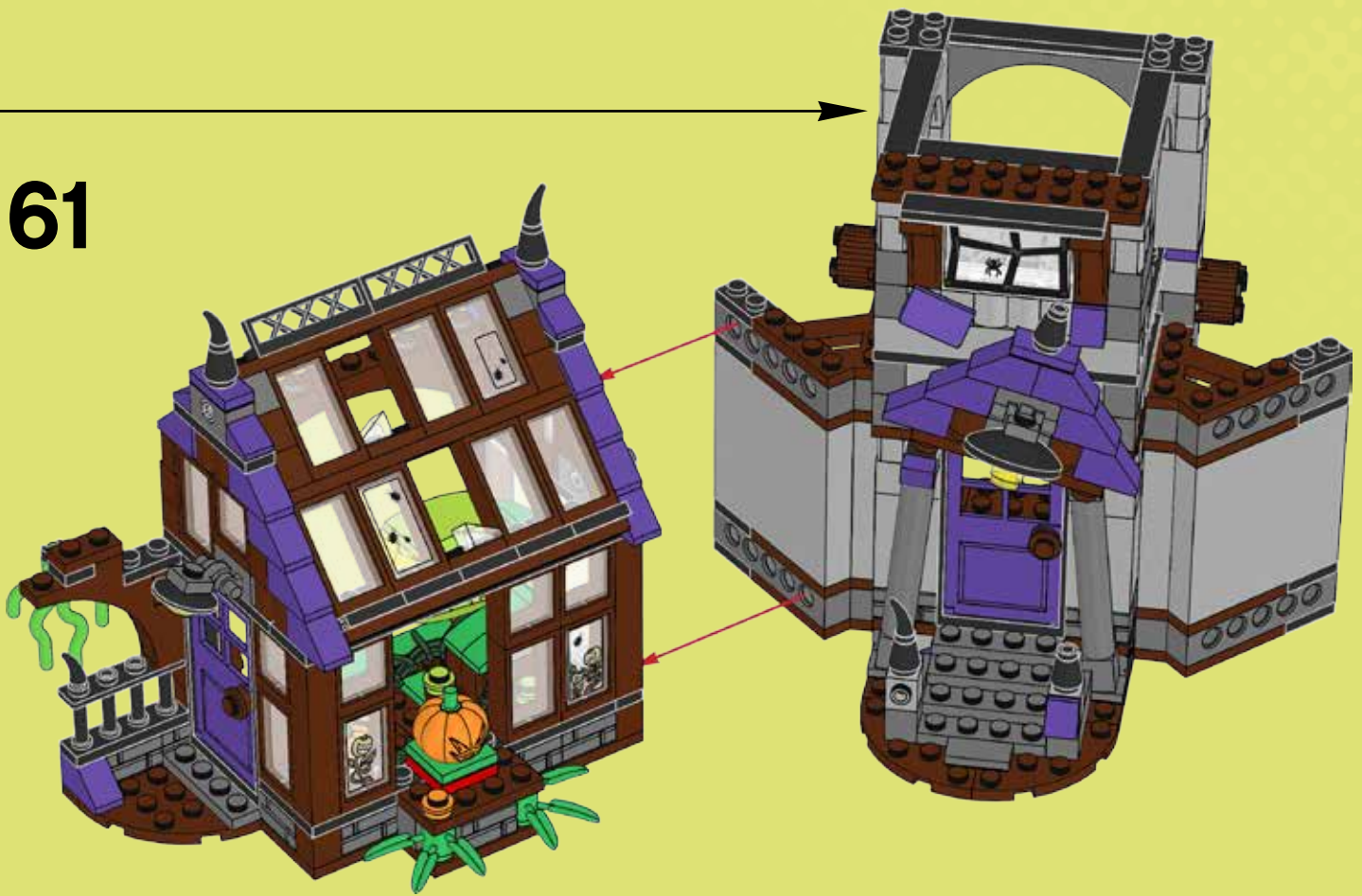

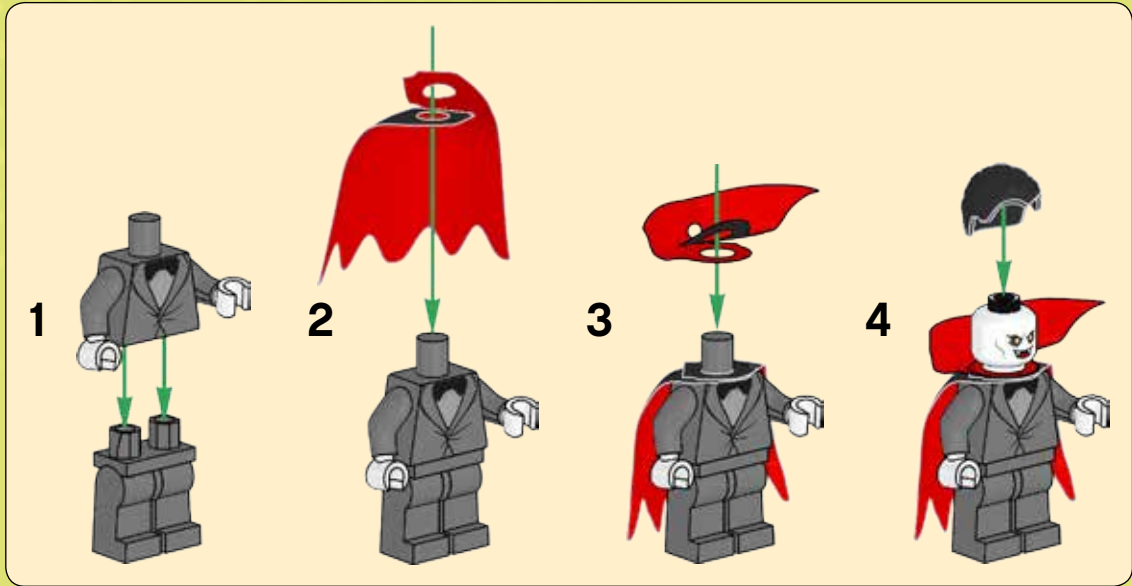
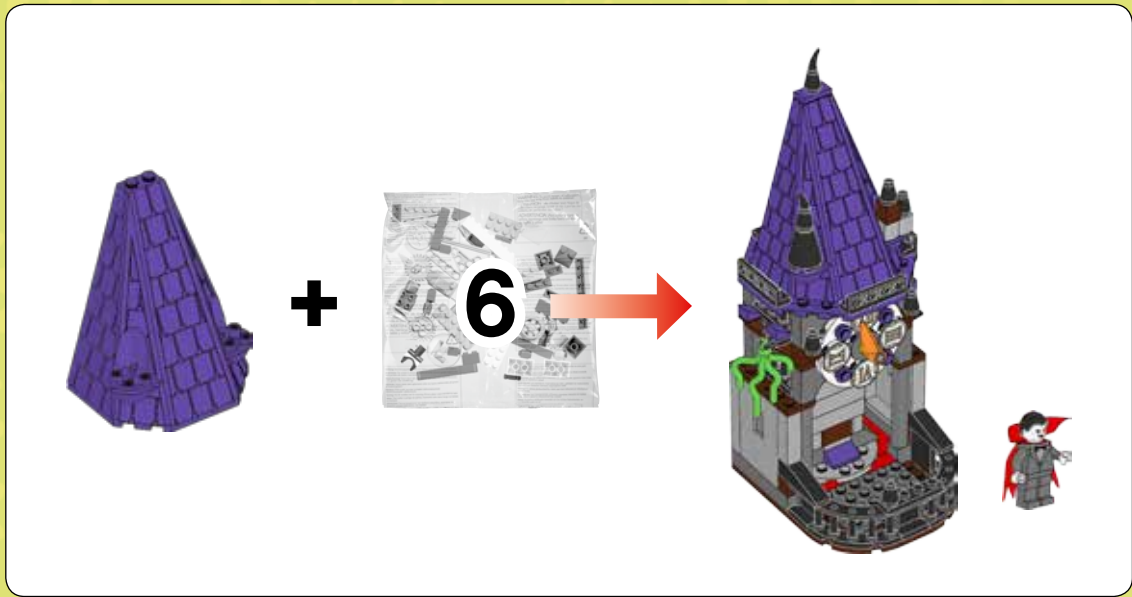

1

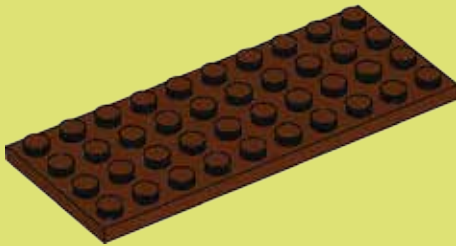

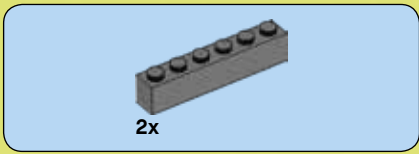

2

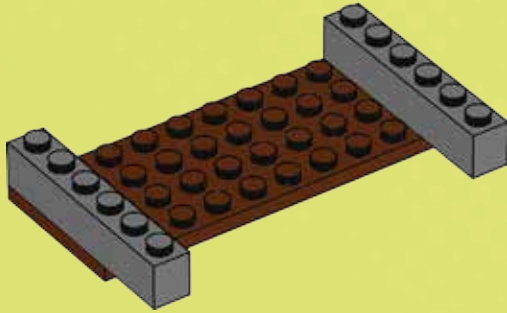

3

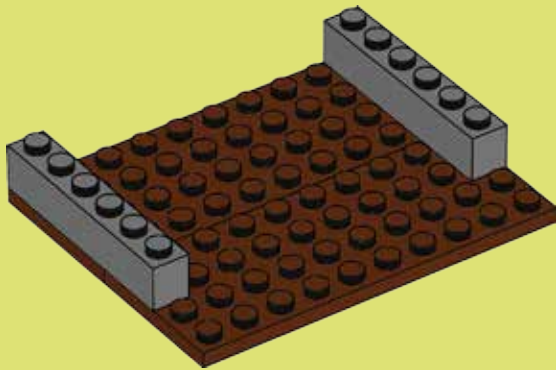

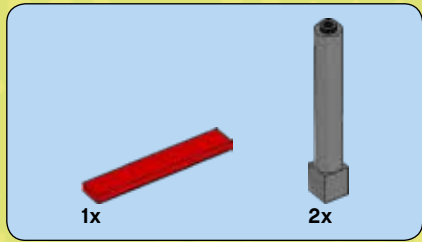

4

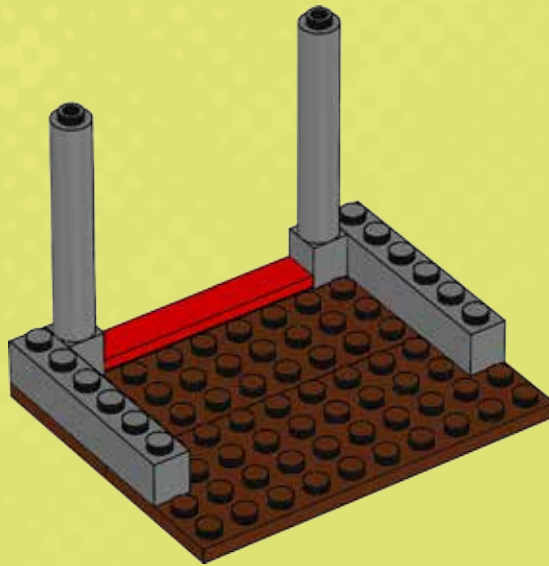

5

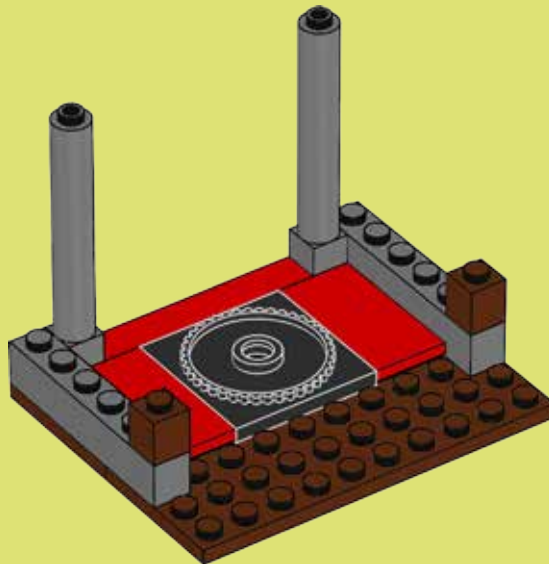

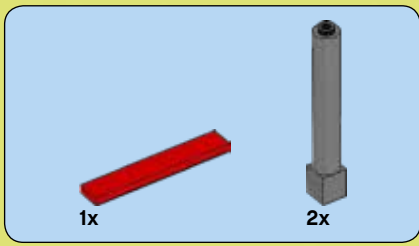

6

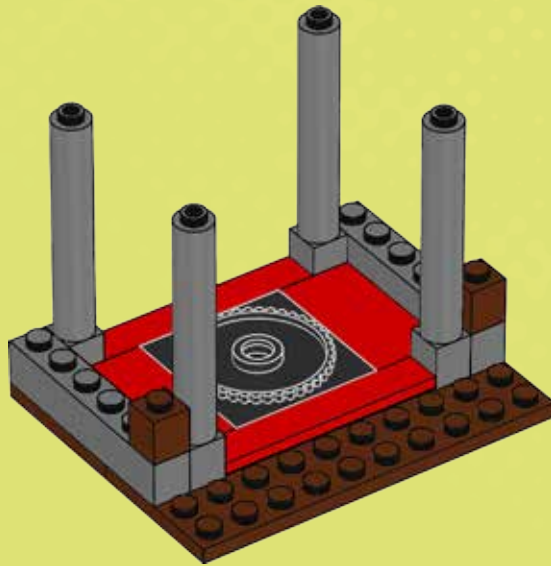

7

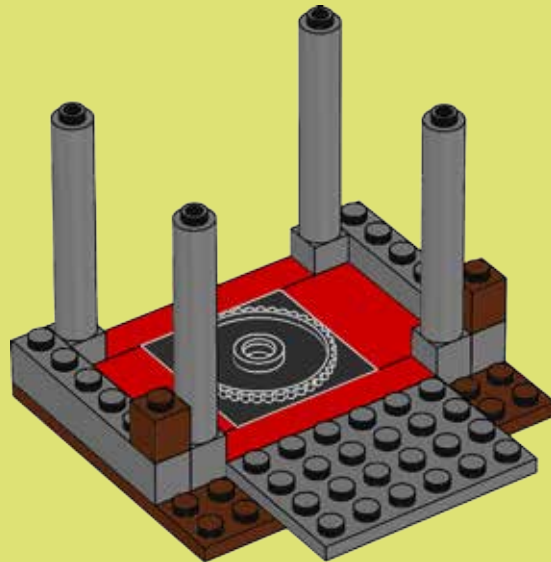



1x

8

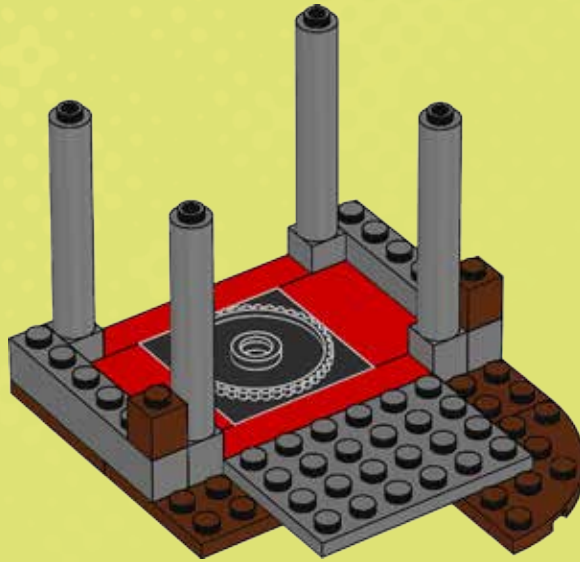

1x



1x

9

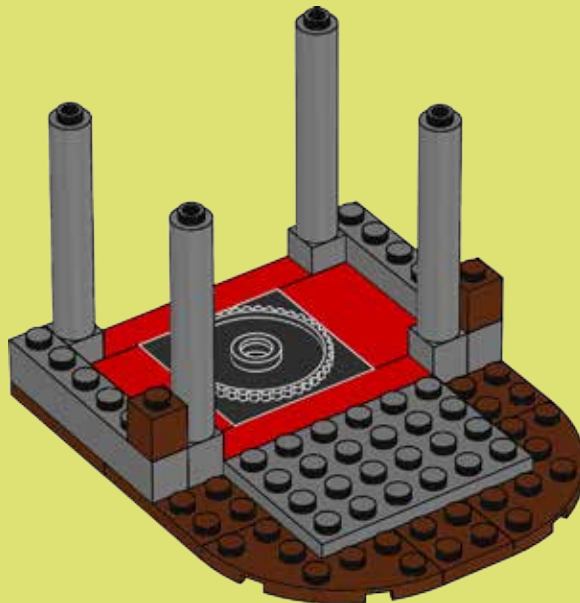



10

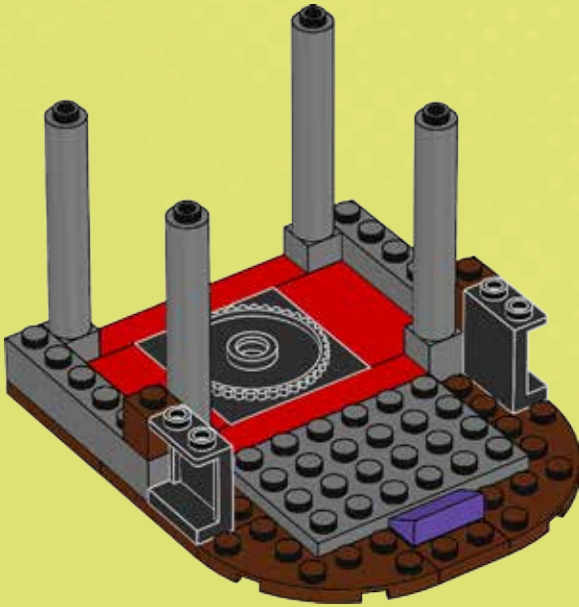

11

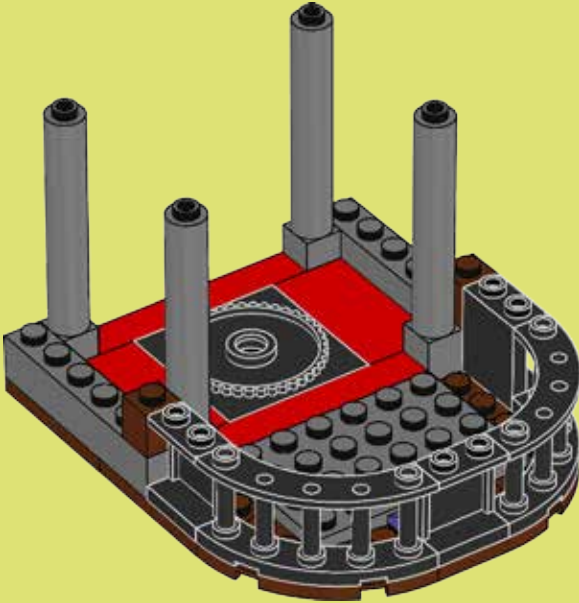



12

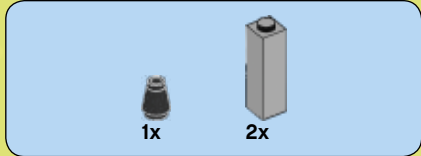
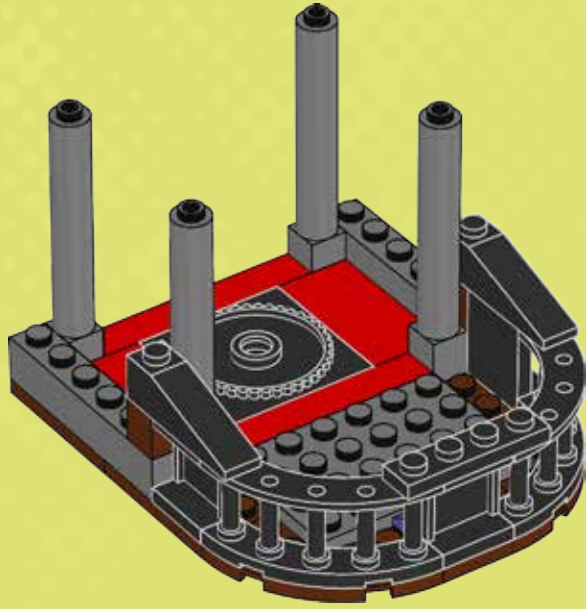

13

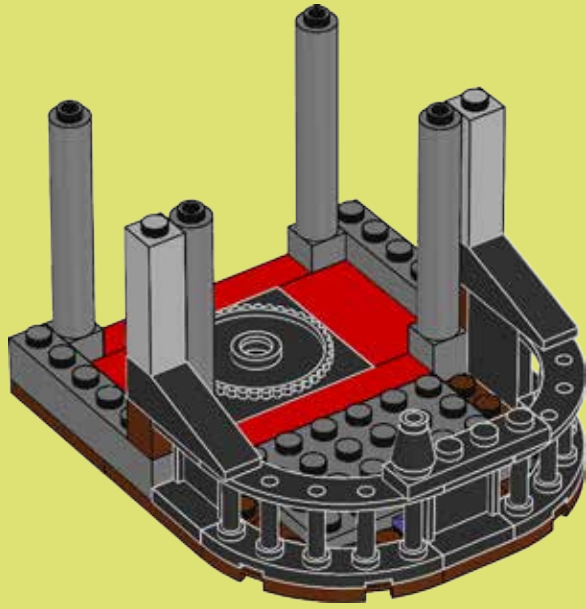

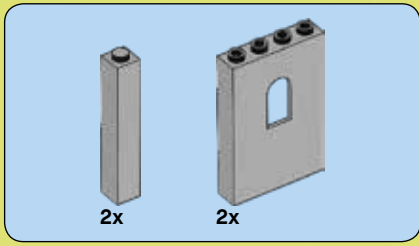

14

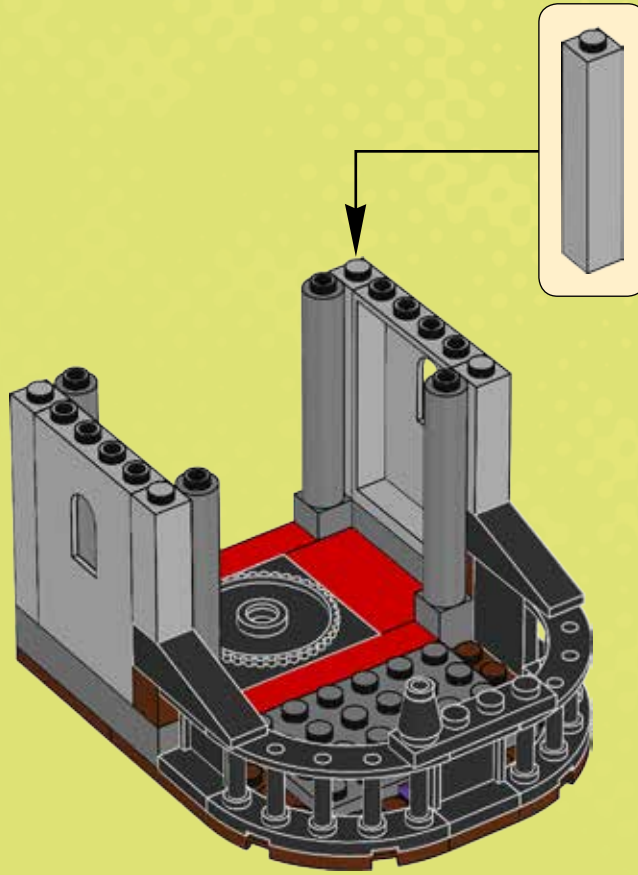

15

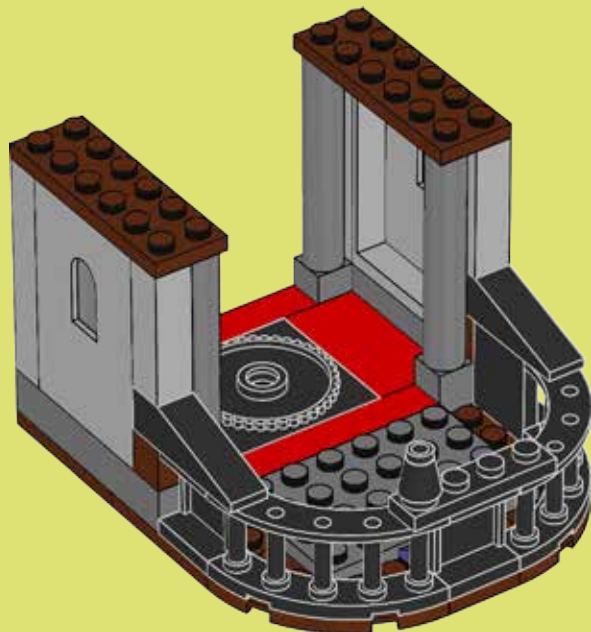

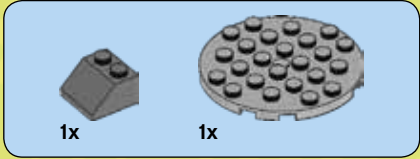

1

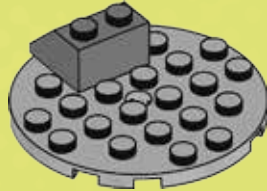

2

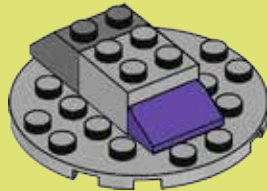

3



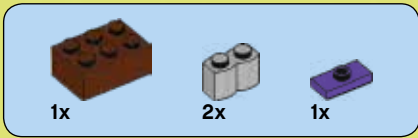

4

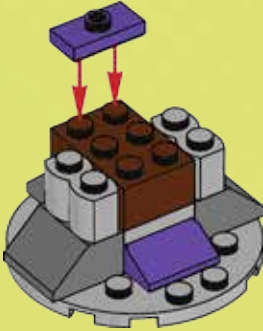

5





3x

6

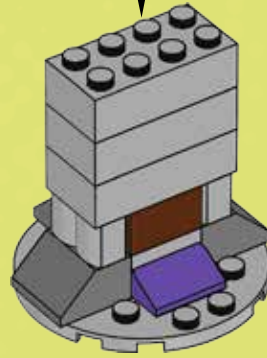
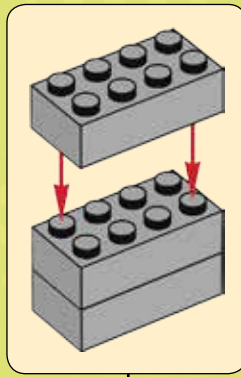

2x

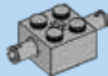

1x

7

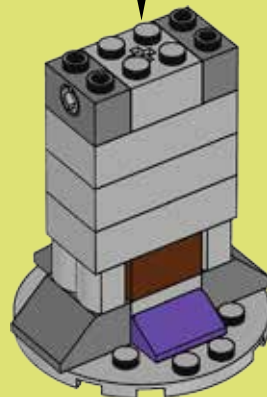
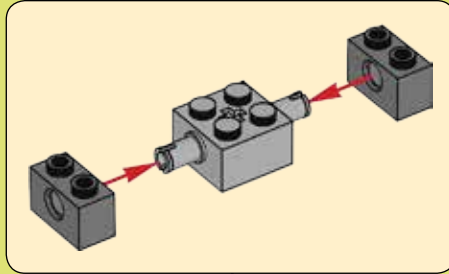



1x



1x

8

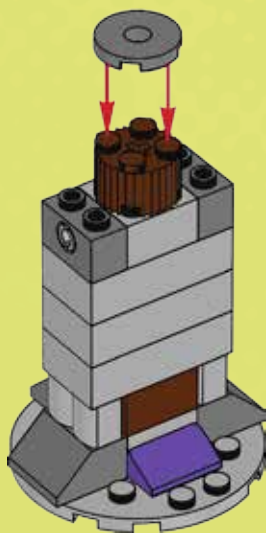

16

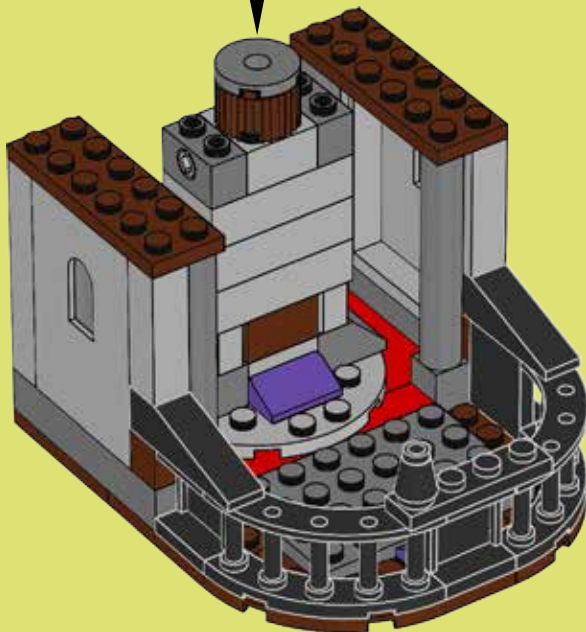

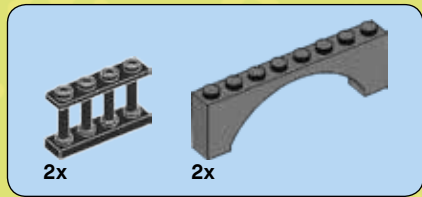

17

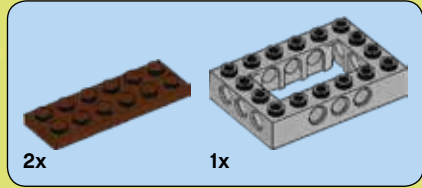
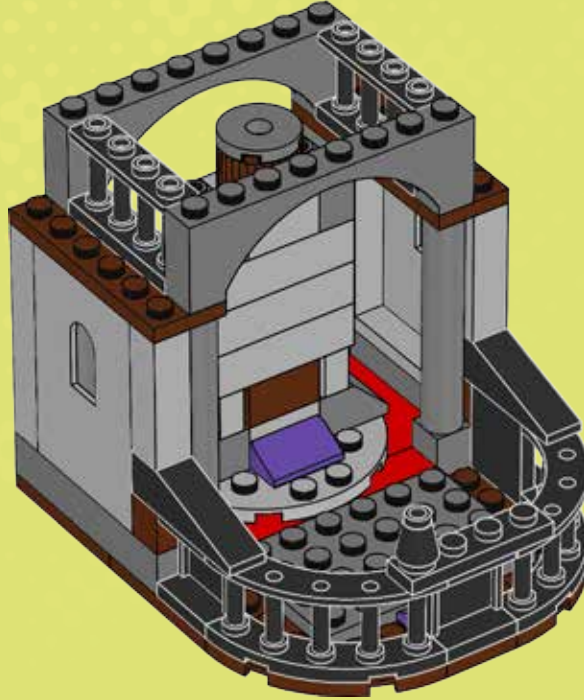

18

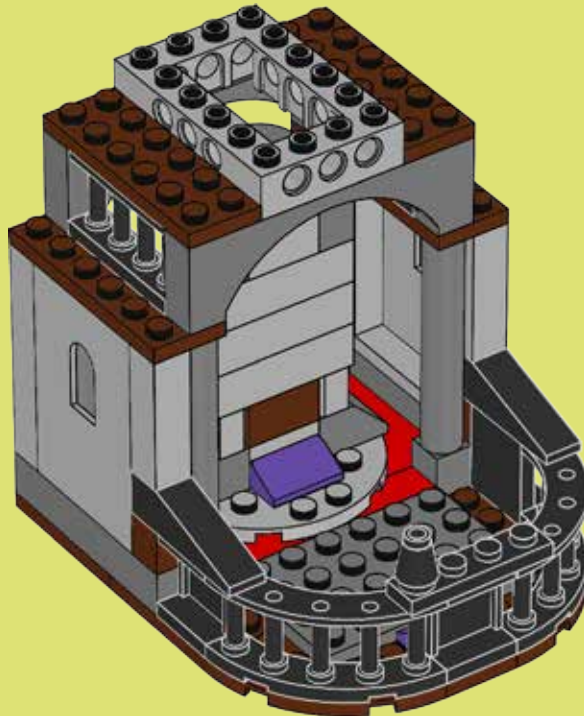



1x

19

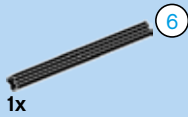
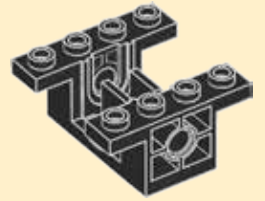
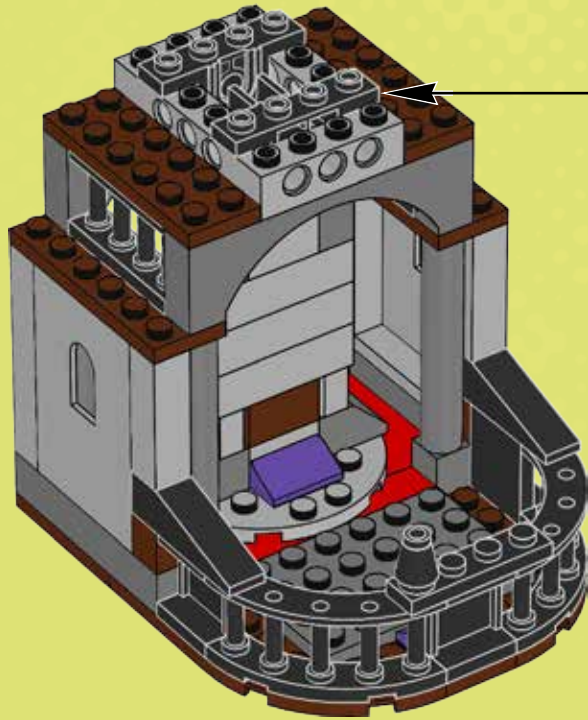

1x

20

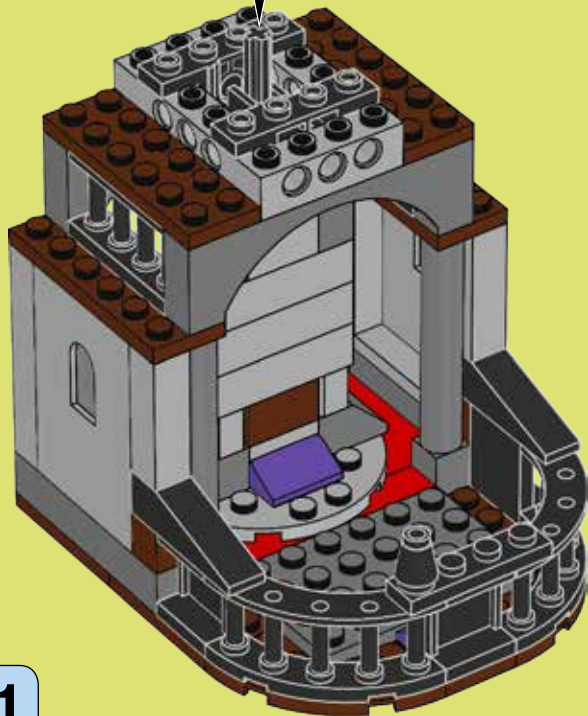

6

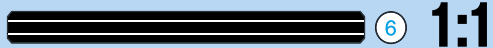

6

1:1



2x

21

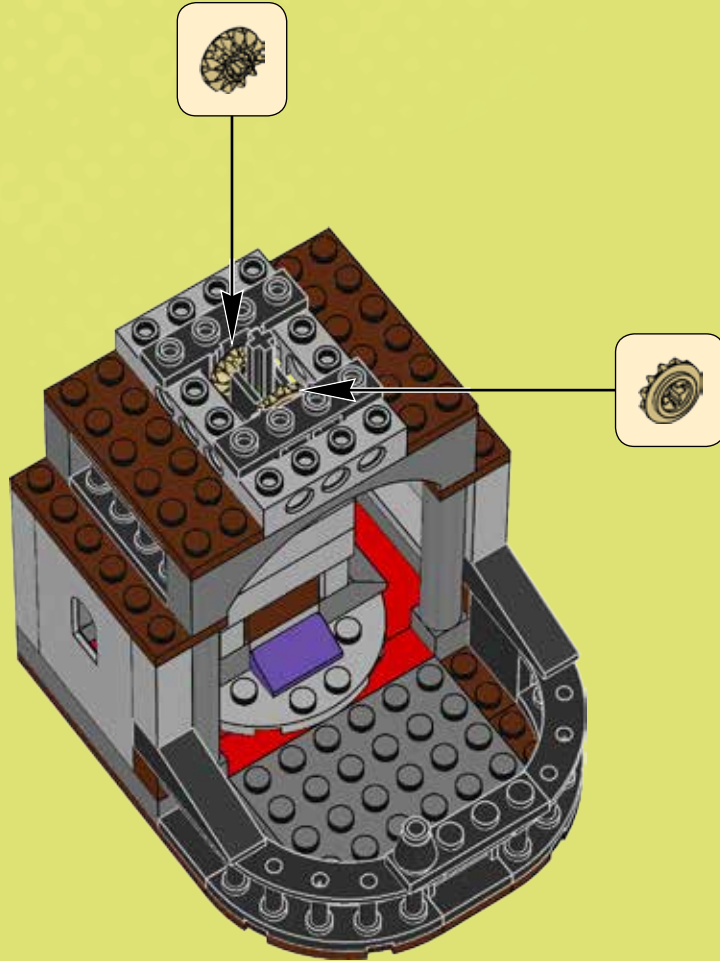



1x

22

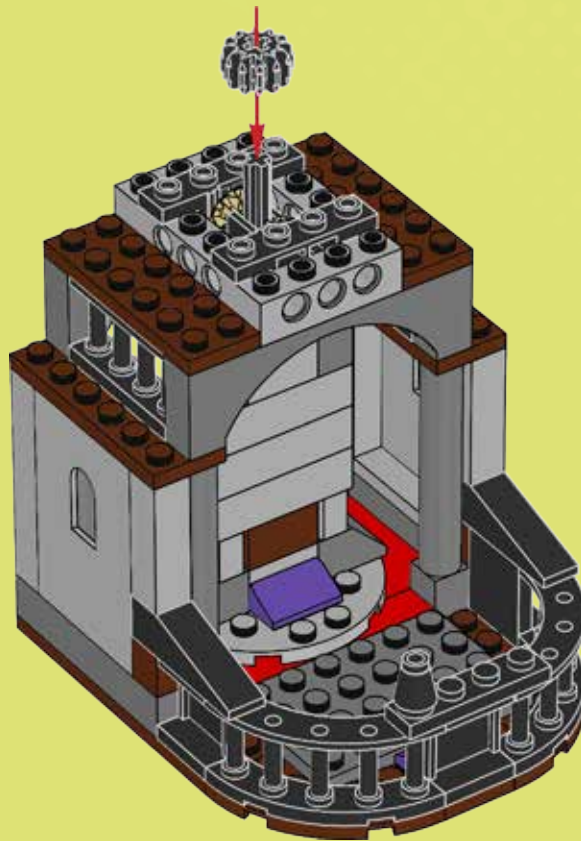

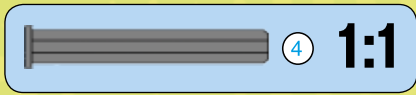

23

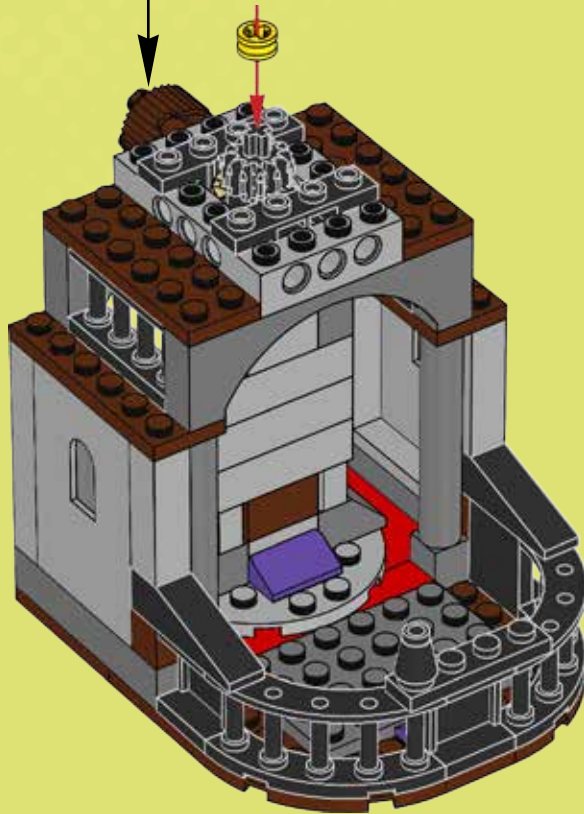
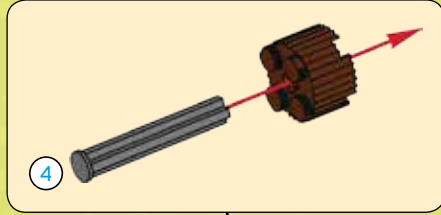



2x

24

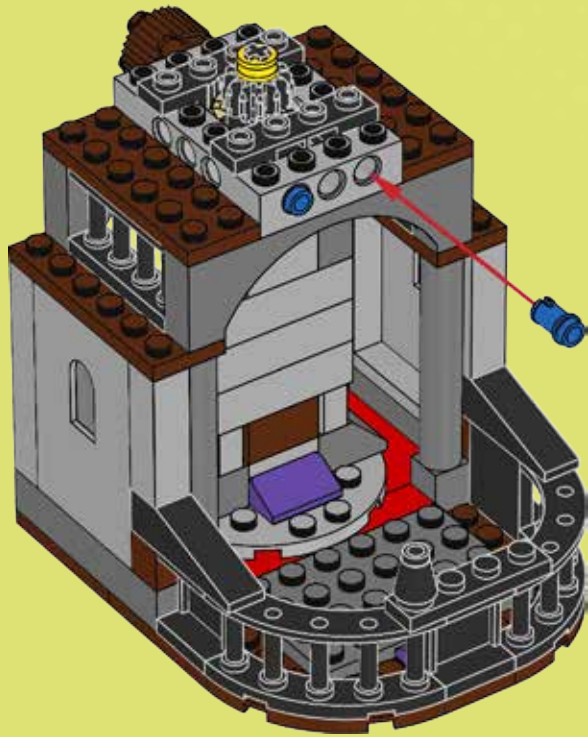

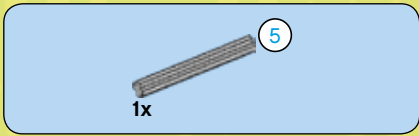

25

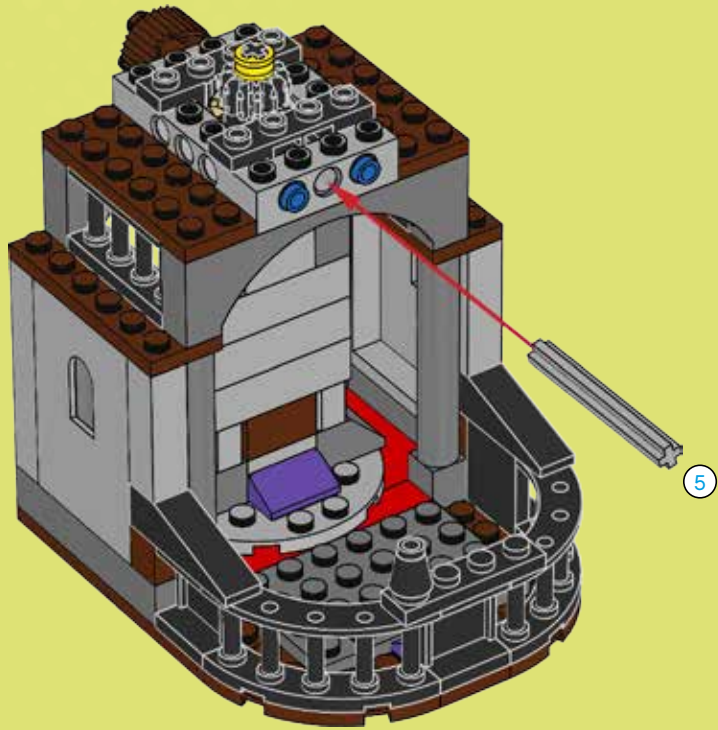



2x

26

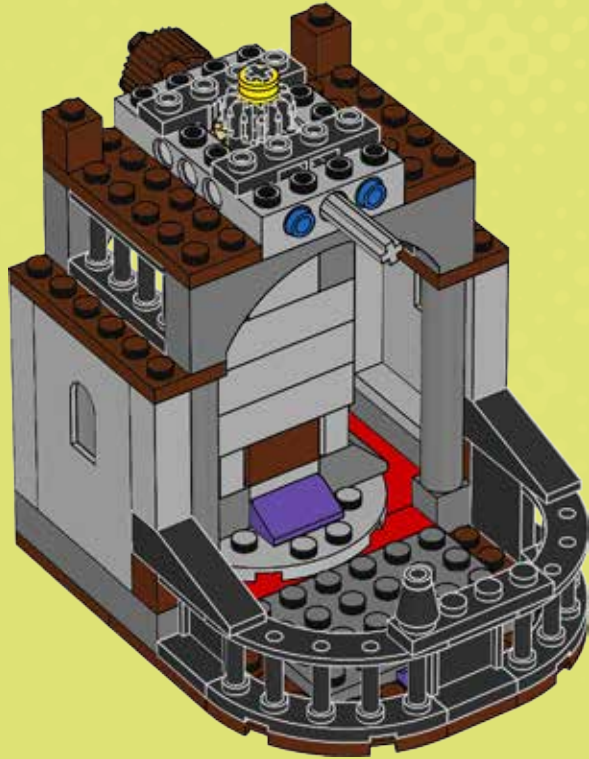

2x



2x

27

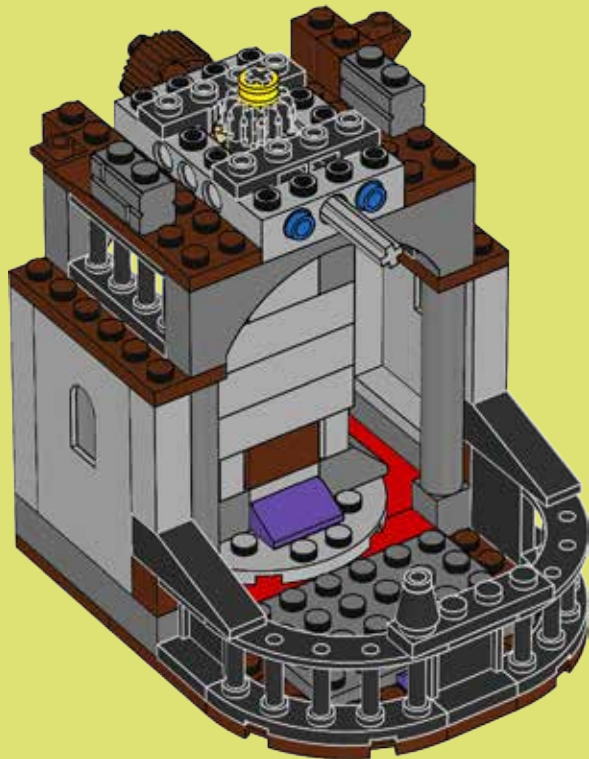



4x

28

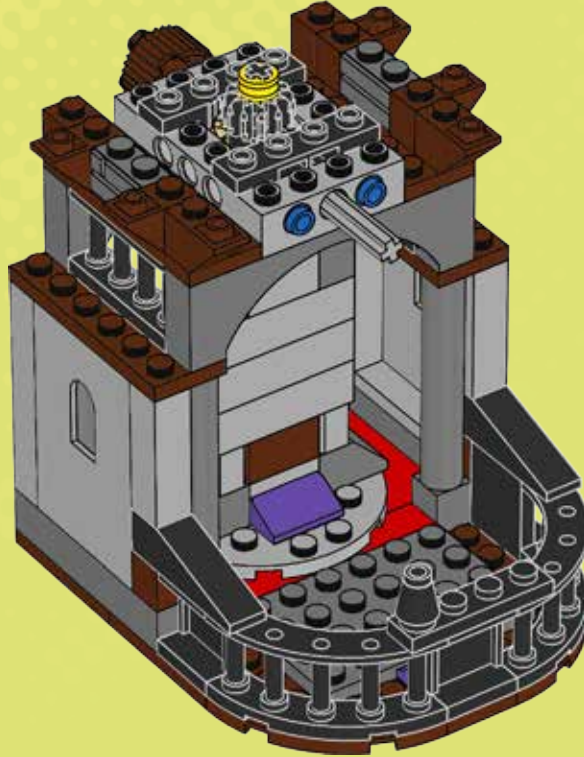

2x

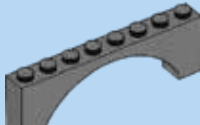

2x

29

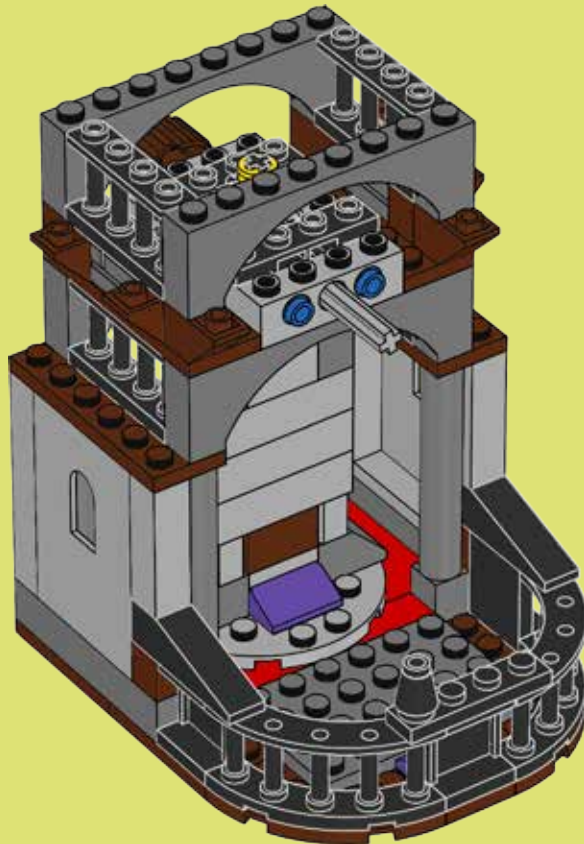



1x



4x

30

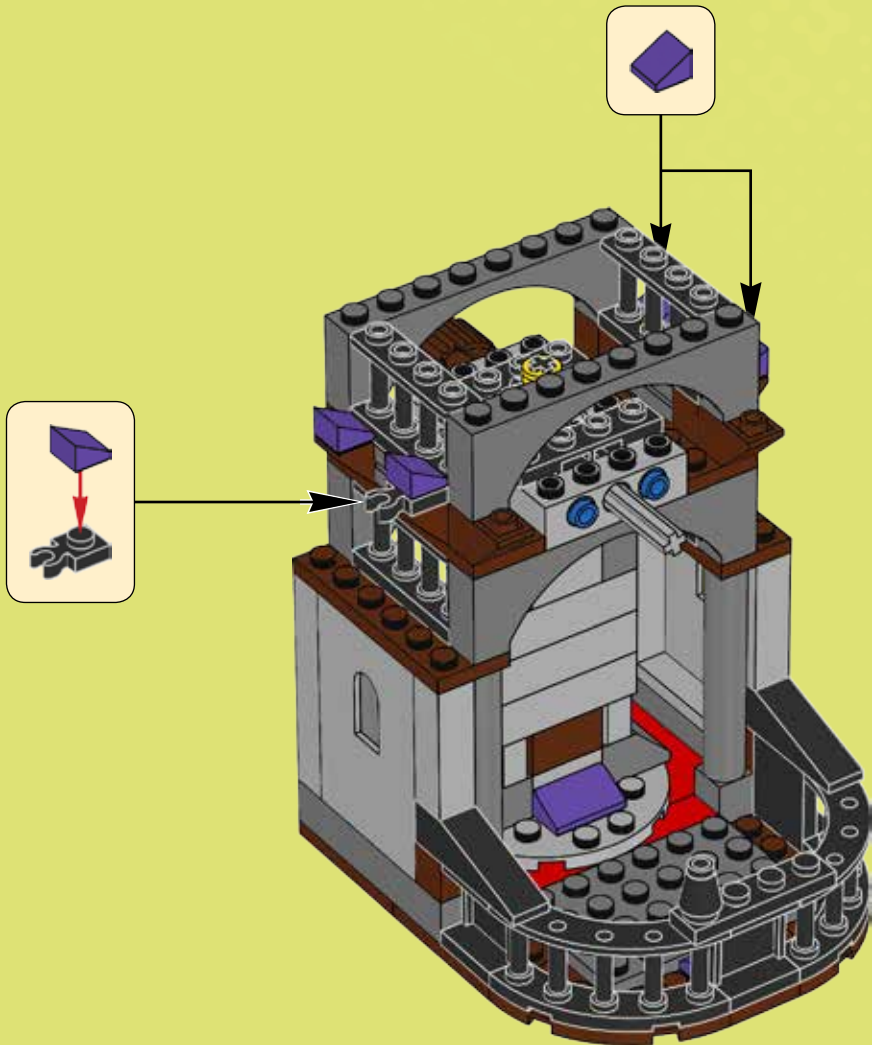

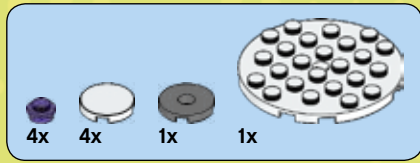

31

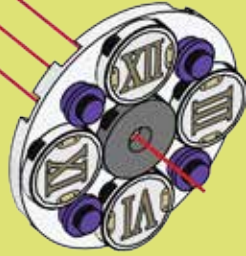
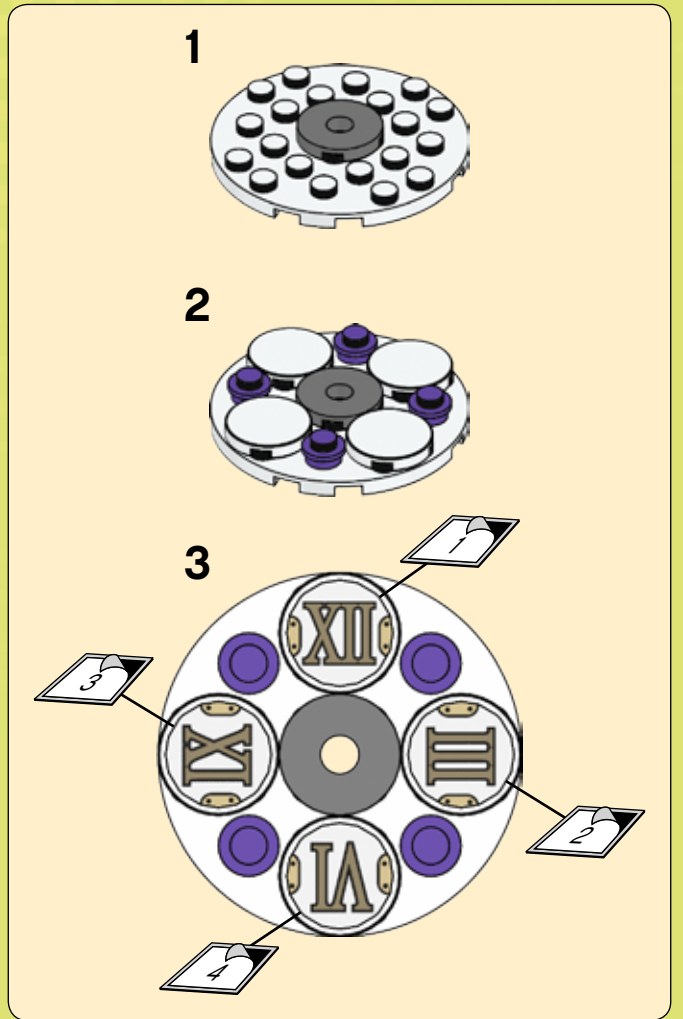
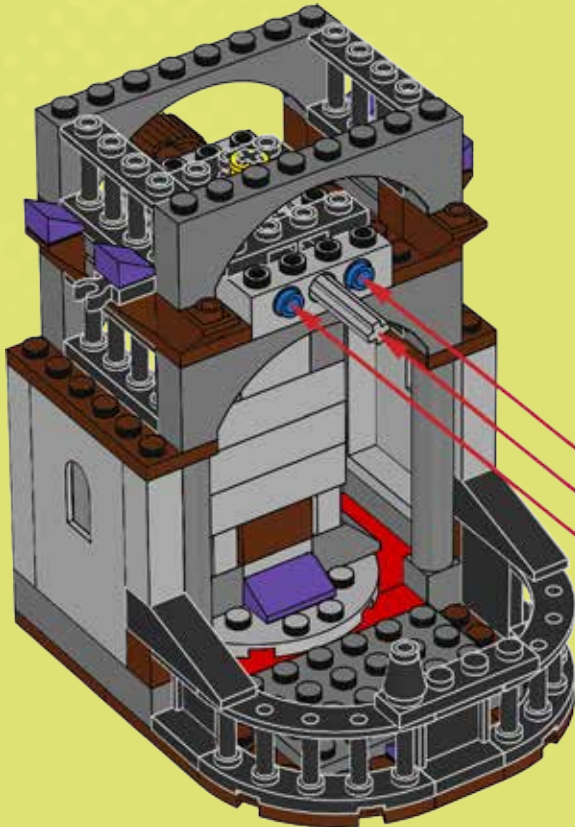



1x



1x

32

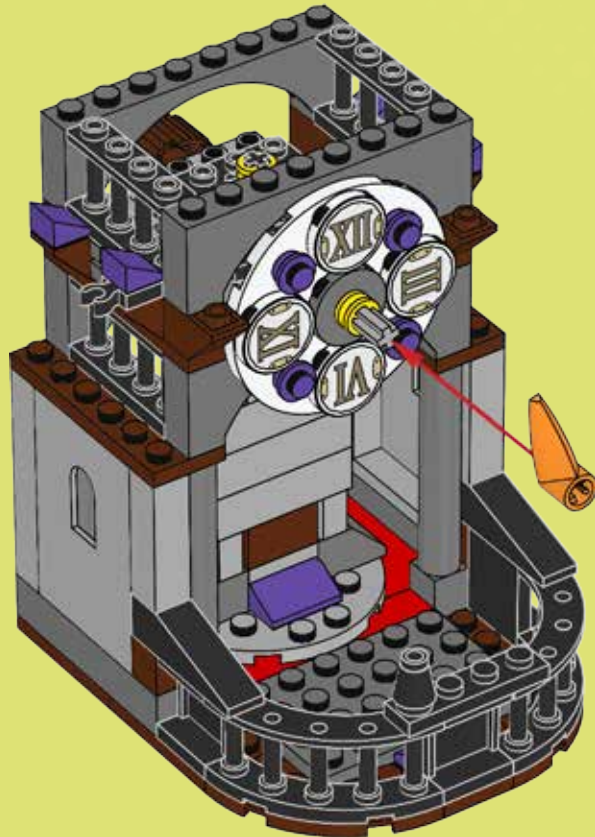

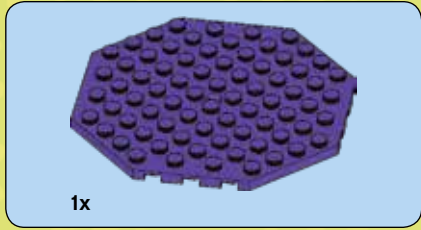

1

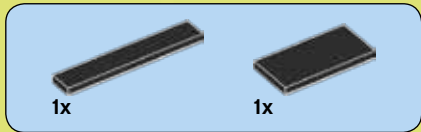
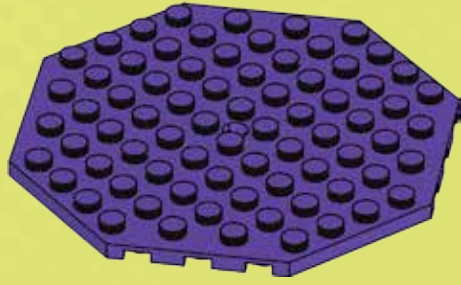

2

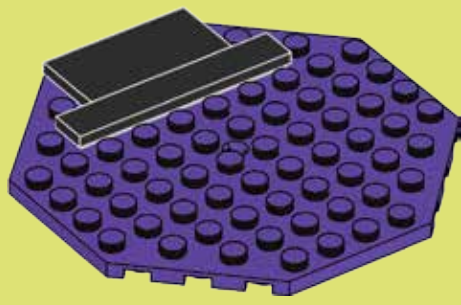



3

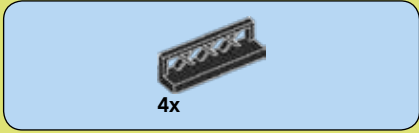
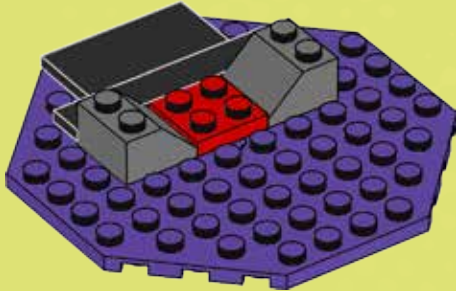

4

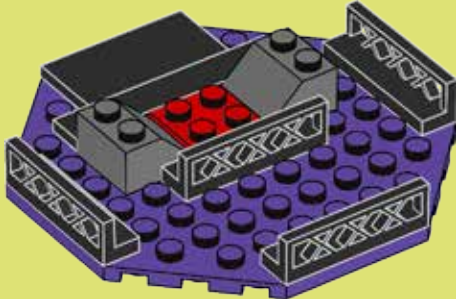

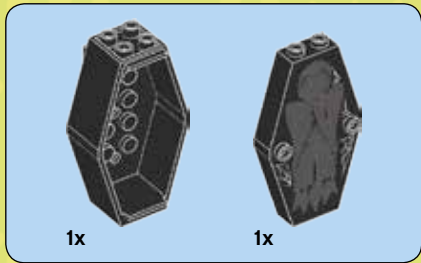

5

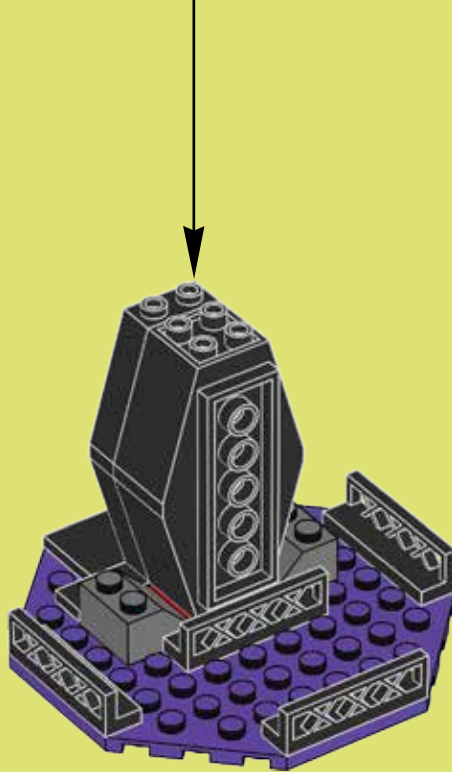
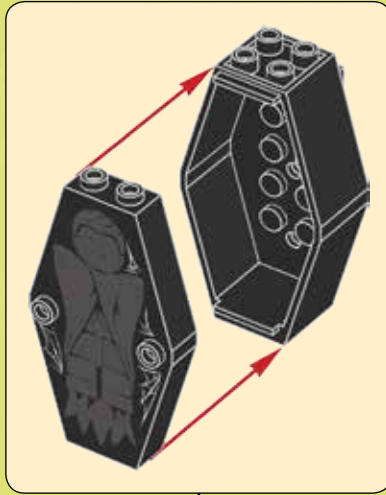

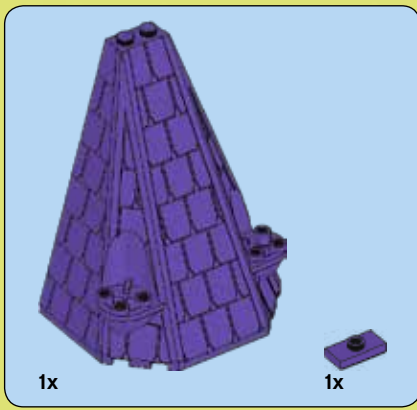

6

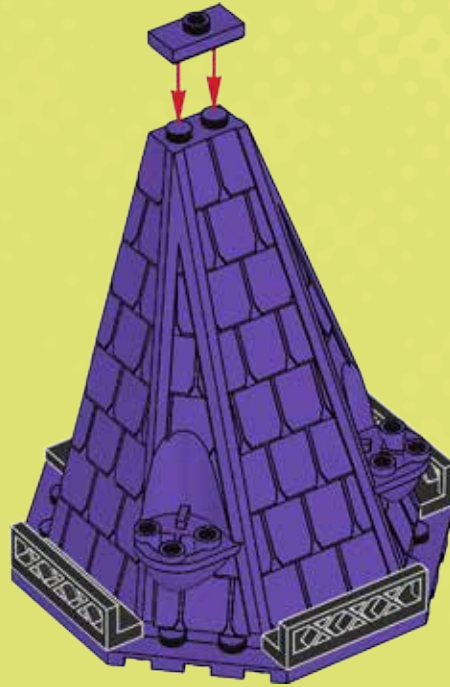

7

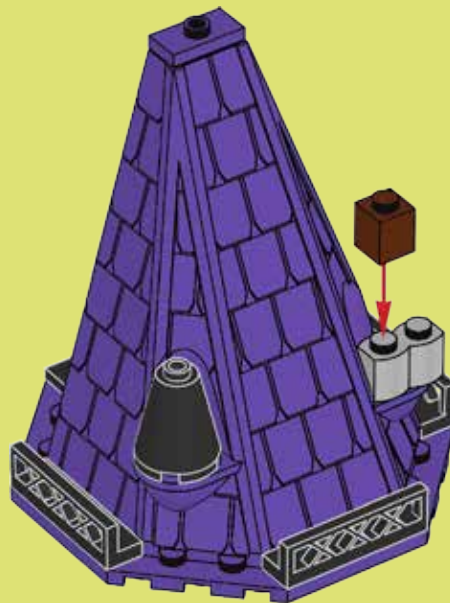



4x

8



2x

9

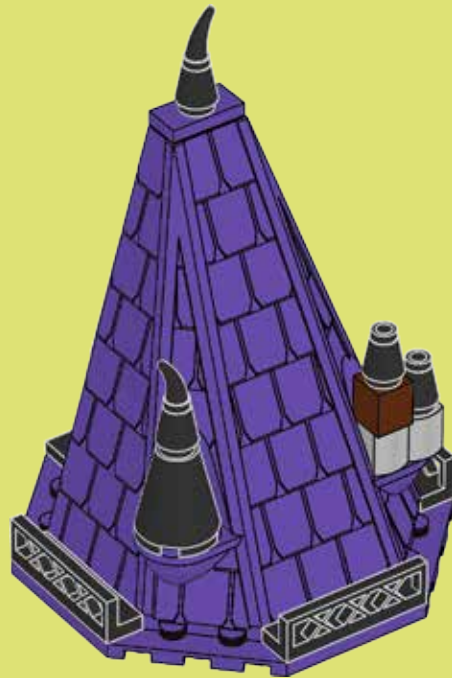

33





34



35

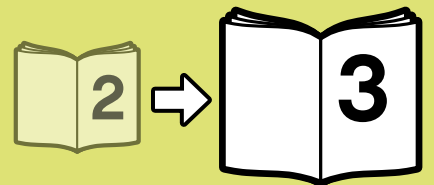



SCOOBY-DOO!

WE'VE GOT A MYSTERY TO SOLVE
WIR MÜSSEN EIN GEHEIMNIS LÜFTEN
NOUS AVONS UN MYSTÈRE À RÉSOUDRE

TENEMOS UN MISTERIO QUE RESOLVER
TEMOS UM MISTÉRIO PARA RESOLVER
MÁIS VAN EGY MEGOLDÁSRA VÁRÓ REJTÉLYÜNK

75900



75901



75902



75903



75904



LEGO.COM/scoobydoo



- 3x 300401
- 1x 300301
- 1x 6123703
- 3x 306801
- 3x 346001
- 4x 6044691
- 1x 6109817
- 2x 623101
- 1x 434601
- 1x 4261470
- 1x 434501
- 1x 4619665
- 1x 9327
- 1x 6009516
- 1x 6122261
- 1x 4651445
- 1x 4600294
- 2x 4143005
- 1x 4523145
- 1x 4113233
- 1x 6115248
- 1x 6122533
- 2x 4565452
- 1x 302221
- 2x 4560179
- 2x 4113858
- 2x 614121
- 2x 4278275
- 1x 6122968
- 1x 4540552
- 1x 4520952
- 1x 368021
- 1x 6119513
- 1x 6119515
- 1x 6012466
- 1x 4541496
- 1x 4233484
- 1x 302224
- 4x 6047218
- 4x 4239601
- 1x 6081988
- 18x 4529236
- 2x 6092664
- 1x 4500978
- 2x 4515362
- 2x 6053077
- 6x 306926
- 15x 302326
- 2x 302226
- 1x 362326
- 5x 371026
- 1x 4560182
- 1x 302026
- 4x 366626
- 7x 663626
- 1x 6066102
- 2x 4550017
- 5x 4107761
- 4x 614126
- 1x 474026
- 1x 4180087
- 1x 4227684
- 3x 4593678
- 1x 4521681
- 2x 4535834
- 1x 6123711
- 1x 6121348
- 1x 4106552
- 1x 4177431
- 8x 346026
- 1x 244526
- 8x 6066113
- 8x 4187209
- 2x 4294570
- 1x 6122408
- 1x 6122463
- 1x 4654944
- 1x 452926
- 1x 6020192
- 9x 4568385
- 1x 4106513
- 1x 4617848
- 2x 6064174
- 1x 393826
- 1x 4517986
- 1x 4500902
- 1x 6055308
- 19x 4121715
- 1x 370526
- 1x 370626
- 1x 6122411
- 1x 4617224
- 2x 4613958
- 1x 6021363
- 2x 6014026
- 2x 4521948
- 2x 4616581
- 1x 4633693
- 1x 6121349
- 1x 6119136
- 1x 6117569
- 1x 6117589
- 1x 6092599
- 2x 4157103
- 1x 6122416
- 1x 6122725
- 2x 6122207
- 1x 4281515
- 1x 4654448

4

6

2x
6047426
 1x
6021539
 3x
306928
 1x
302328
 2x
4565321
 1x
371028
 2x
243128
 1x
4296081
 2x
4556159
 2x
4521931
 2x
4114348
 3x
6059027
 1x
6092601
 3x
4179825
 4x
4581079
 2x
4255624
 1x
4569217
 1x
4505066
 2x
4294148

4x
4216581
 8x
6084573
 5x
4636170
 2x
4211189
 3x
4211190
 6x
4211194
 3x
4211186
 1x
4211204
 2x
4221590
 5x
4243838
 7x
4211247
 4x
4211211
 2x
4217848
 3x
4223683
 4x
4223729
 4x
4225715
 1x
4225700

30x
4211242
 3x
4226966
 9x
4211180
 1x
4216668
 2x
4225469
 2x
4211183
 4x
6036503
 1x
4504376
 1x
4270470
 6x
4211222
 1x
6121737
 1x
4598713
 1x
4211202
 2x
4211197
 4x
6055086
 2x
6044725
 3x
6096379

3x
4211150
 1x
4211151
 2x
4271949
 1x
4211257
 1x
4211152
 13x
6058084
 6x
4595814
 2x
6061702
 2x
4211362
 42x
4550325
 2x
4211564
 8x
4211387
 4x
4211650
 7x
4211394
 5x
4211385
 10x
4211393
 1x
4211392

12x
4558953
 2x
4533772
 1x
4211752
 1x
4211716
 2x
6007894
 2x
6106189
 1x
6063898
 1x
4211395
 1x
4211837
 1x
6043656
 4x
4211376
 1x
6015349
 2x
4537056
 4x
4527174
 1x
4211503
 1x
4610112

1x 4512743
 2x 4590443
 1x 4540203
 1x 4211469
 1x 4563045
 1x 4211758
 1x 4211807
 1x 4211815
 1x 4211639
 1x 4164022
 2x 4212446
 2x 6023954
 1x 4164037
 1x 4537936
 9x 4183133
 1x 6117683
 2x 4619513
 2x 4625036
 1x 6070379
 1x 6070380

23x 6000311
 22x 4211104
 1x 4211085
 2x 4211100
 2x 4210875
 2x 4211128
 1x 4210725
 6x 4180811
 6x 4210639
 23x 4211111
 8x 4210917
 5x 4211054
 5x 6079721
 1x 6092649
 2x 4210848
 1x 4211052
 2x 4211001
 3x 4211065

1x 4243831
 1x 4211115
 3x 4579354
 1x 6039479
 1x 6039482
 2x 6055313
 2x 4222693
 1x 6122280
 2x 4516546
 4x 6083620
 2x 6109820
 1x 6109819
 4x 6109812
 1x 6029584
 1x 6056448

15x 4567509
 7x 4566607
 6x 6022070
 25x 6109814
 2x 6055877
 2x 4655695
 6x 6092604
 4x 4566522
 1x 6122746
 1x 6122736
 1x 6123944
 1x 6122731
 1x 6122133
 1x 6004714
 1x 6022033
 3x 6051823
 1x 6005030

2x 4244362
 2x 3005740
 13x 4536998
 6x 6024020
 2x 6000740
 3x 6010737
 1x 6054554
 1x 4594686
 1x 4504229
 1x 4567332
 1x 3005744
 2x 6039180
 1x 6055651

Customer Service
 Kundenservice
 Service Consommateurs
 Servicio Al Consumidor
 LEGO.com/service or dial

: 00800 5346 5555
 : 1-800-422-5346

More spooky fun at / Noch mehr Gruselspaß auf /
Plus d'amusement effrayant sur / Mäs diversión tenebrosa en /
Mais diversão arrepiante em / További rémisztő móka itt
LEGO.com/scoobydoo



SCOOBY-DOO!

LEGO and the LEGO logo are trademarks of the LEGO Group. ©2015 The LEGO Group. 6132710



TM & © Hanna-Barbera.
WB SHIELD: TM & © Warner Bros. Entertainment Inc.
(s15)

Apple, the Apple logo, iPad, iPhone and iPod touch are trademarks of Apple Inc.
Google Play is a trademark of Google Inc.

