



F.R.I.E.N.D.S  
THE TELEVISION SERIES



## APARTAMENTOS 19 Y 20 CIUDAD DE NUEVA YORK (NUEVA YORK)

Desde las paredes púrpura del cuarto de estar de Monica hasta los sillones reclinables para ver el televisor de Chandler y Joey, cada elemento de este homenaje a tu serie de televisión favorita, el más reciente de LEGO®, te hará sentir como en casa si eres un verdadero fan de Friends. Además de capturar la inconfundible decoración de los dos apartamentos y del recibidor que los conecta, este set está repleto de detalles y referencias a momentos inolvidables del programa.





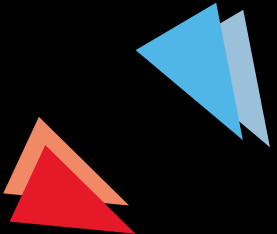

## APARTAMENTO DE CHANDLER Y JOEY

En comparación con el apartamento de las chicas, ubicado al otro lado del pasillo, el apartamento de Chandler y Joey es más pequeño, está más desordenado y representa el hogar ideal para dos jóvenes solteros que viven en Manhattan, el corazón de Nueva York. Aunque todos los personajes principales del programa vivieron en ese apartamento en algún momento, los accesorios del set corresponden al clásico período en el que Chandler y Joey eran sus felices moradores.





## APARTAMENTO DE MONICA Y RACHEL

Ubicado en Greenwich Village, el vecindario de Nueva York, y antiguo hogar de la abuela de Ross y Monica, el apartamento de Monica y Rachel, con su enorme cuarto de estar y cocina abierta, es una mezcla ecléctica de colores llamativos y muebles sobrecargados de accesorios: ¡todo lo opuesto al carácter obsesivamente ordenado de Monica!





## EL RECIBIDOR

El pequeño espacio que separa ambos apartamentos fue el escenario del famoso episodio en el que Chandler y Rachel pelean por un trozo de pastel que cae al suelo, terminan comiéndolo de allí, ¡y Joey se une posteriormente al festín!





## EL DISEÑADOR

● No sabía mucho del programa cuando comencé a trabajar en el modelo. Por eso, lo que más disfruté de este set fue hablar con los fans del programa con quienes trabajo y escucharlos relatar sus momentos favoritos de este... Podían contar una anécdota tras otra y reír una y otra vez recordando un sinfín de acontecimientos. Espero que el set traiga la misma alegría a todos los que lo construyan.

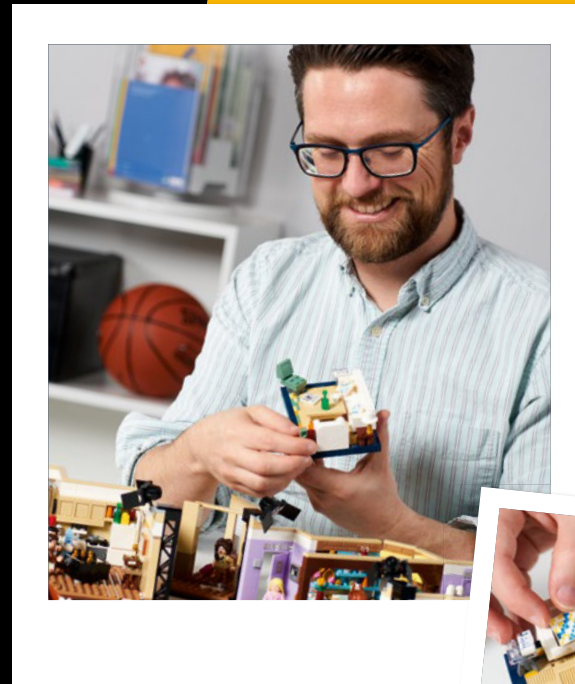

## LOS PERSONAJES

El set incluye siete minifiguras: las de los seis personajes principales y la de Janice Hosenstein, eterna pareja intermitente de Chandler con una voz muy peculiar.



### ROSS GELLER

T5-E11:  
"El de los propósitos"  
Ross presume sus pantalones de cuero.



### MONICA GELLER

T7-E9:  
"El de todos los caramelos"  
Monica hace caramelos para los vecinos.



### RACHEL GREEN

T1-E19:  
"En el que el mono se escapa"  
¡Rachel pierde a un mono!



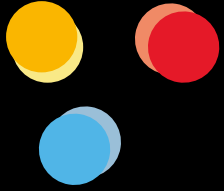

### PHOEBE BUFFAY

T6-E7:  
"En el que Phoebe corre"  
Phoebe vive con Rachel.



### JOEY TRIBBIANI

T3-E2:  
"En el que nadie está listo"  
Joey se pone toda la ropa de Chandler.



### CHANDLER BING

T4-E2:  
"El del gato"  
¡Cuando Chandler olvida girar  
y salir!



### JANICE HOSENSTEIN

T7-E7:  
"El del libro de Ross de la biblioteca"  
Janice se autoinvita a la boda de  
Chandler y Monica.





[LEGO.com/brickseparator](https://www.lego.com/brickseparator)

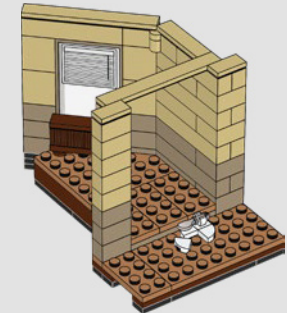
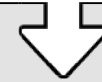
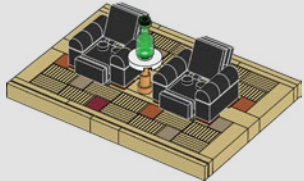



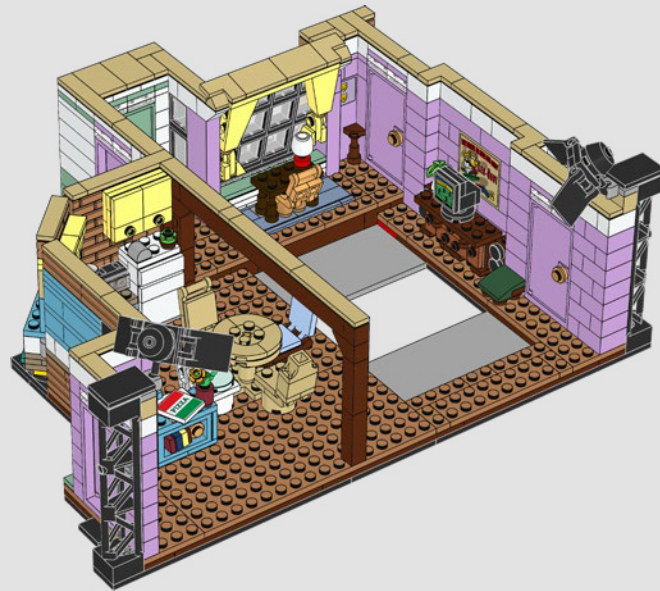
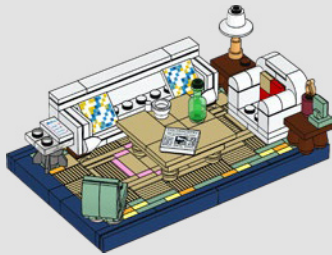

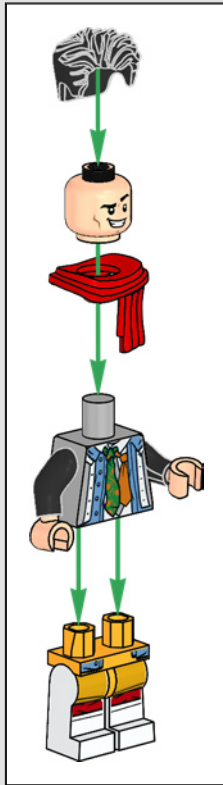
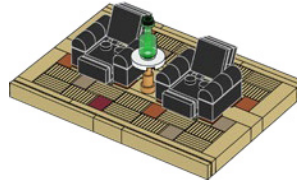

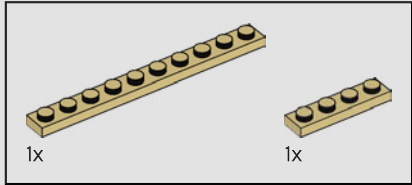
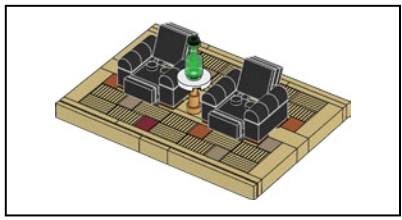

1

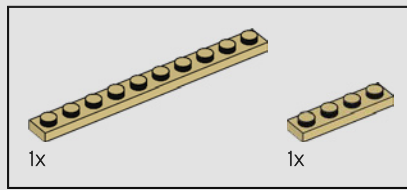
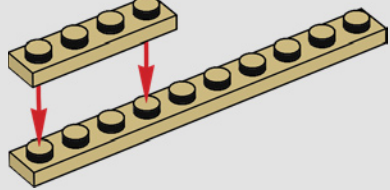

2

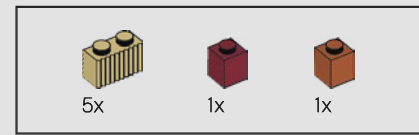
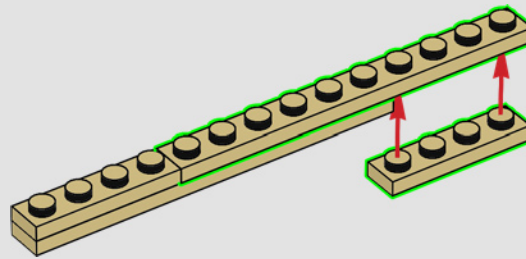

3

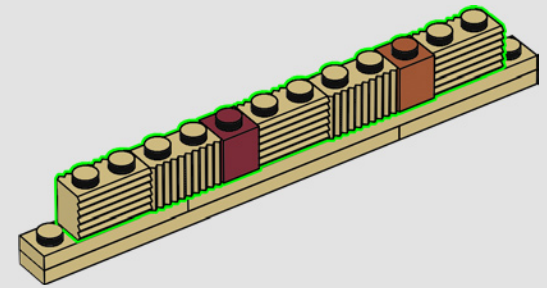

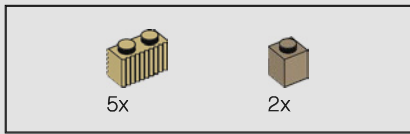

4

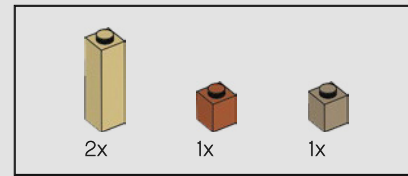
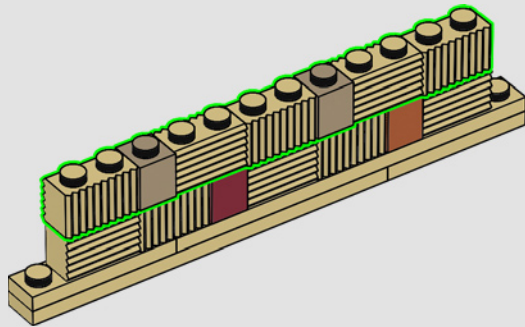

5

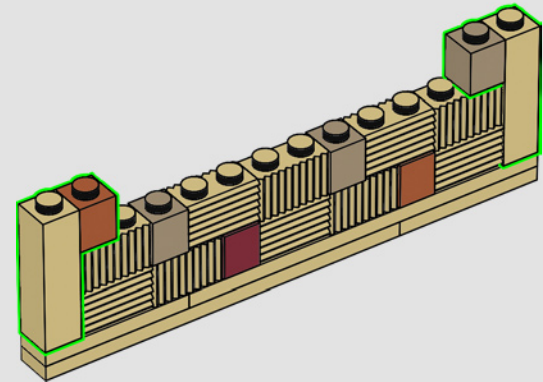

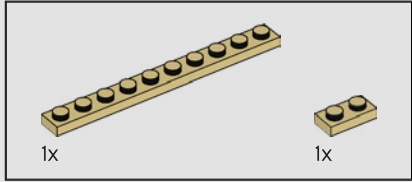
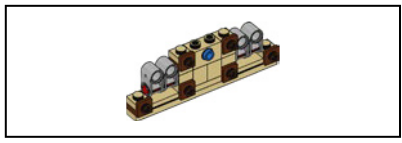

6

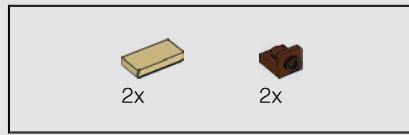
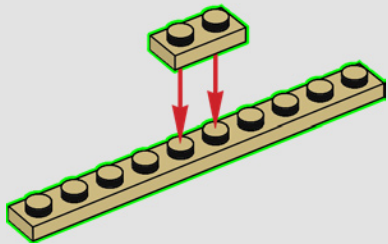

7

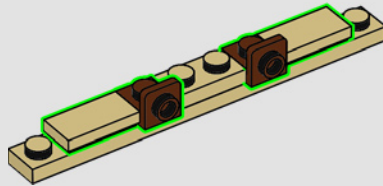

8

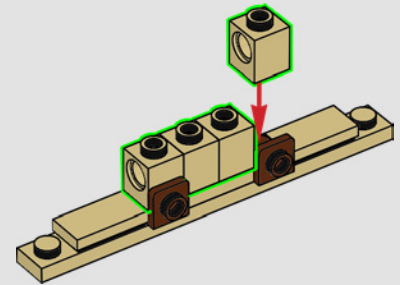



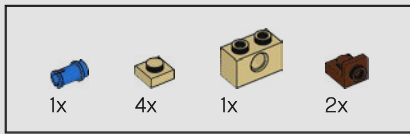

9

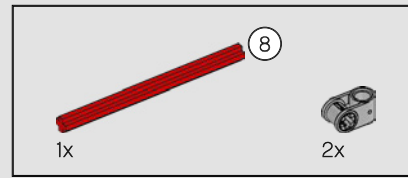
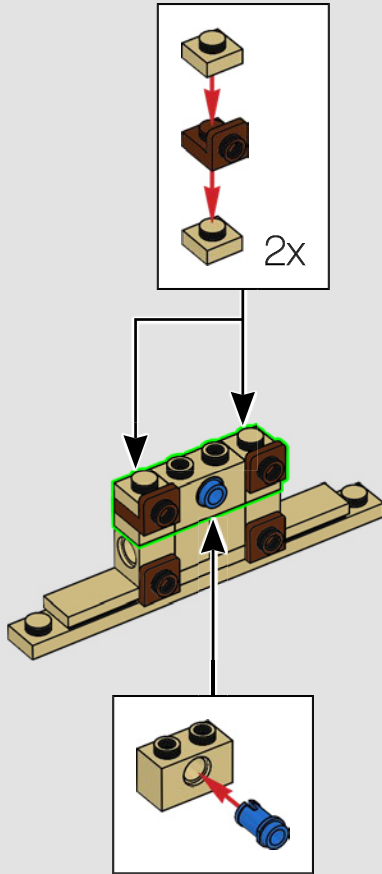

10

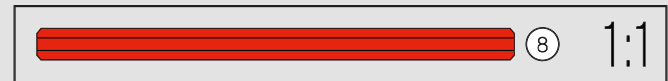
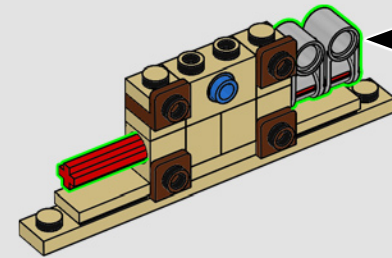
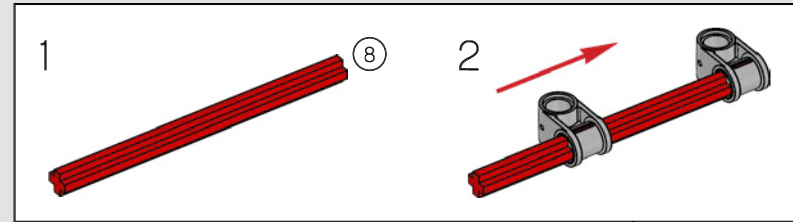



2x

11

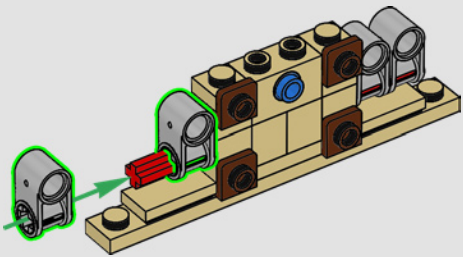

2x



2x

12



2x

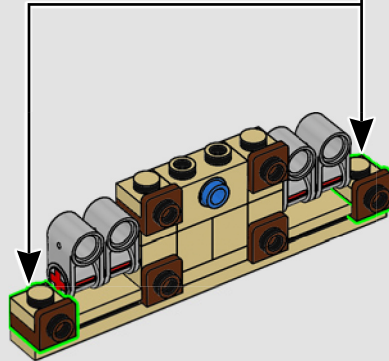

13

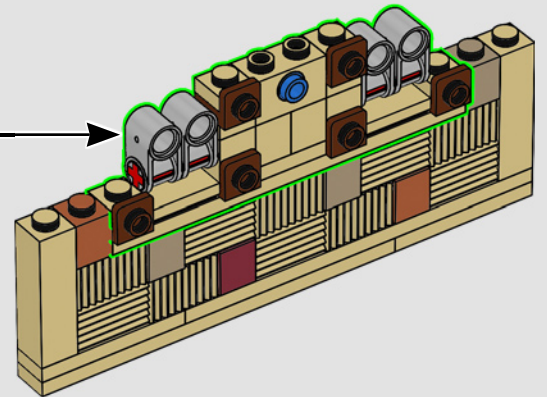

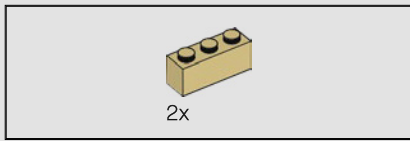

14

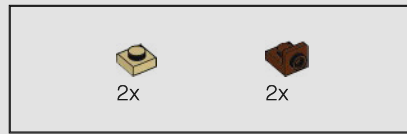
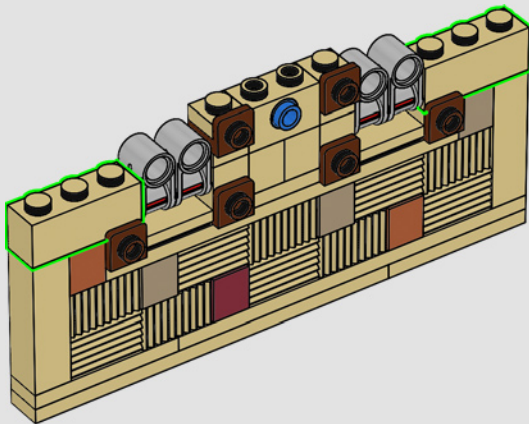

15

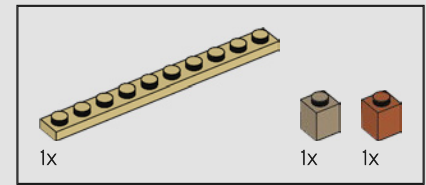
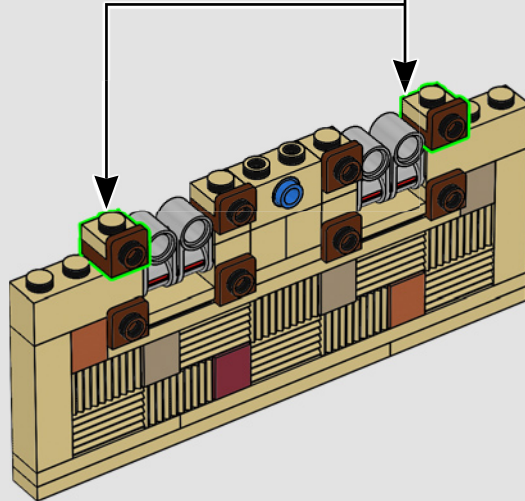
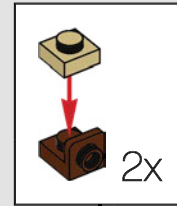

16

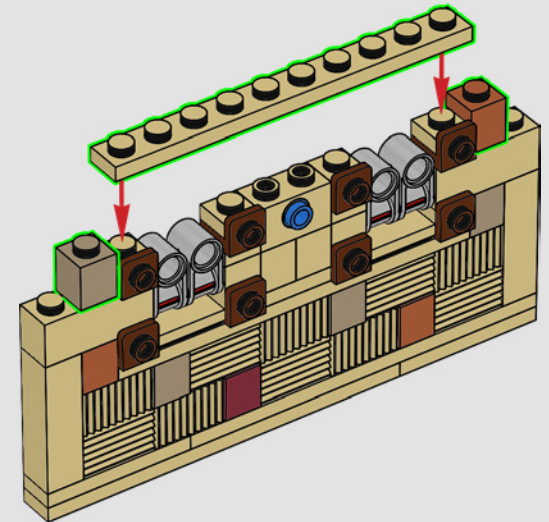

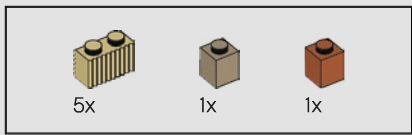

17

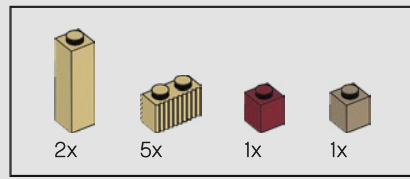
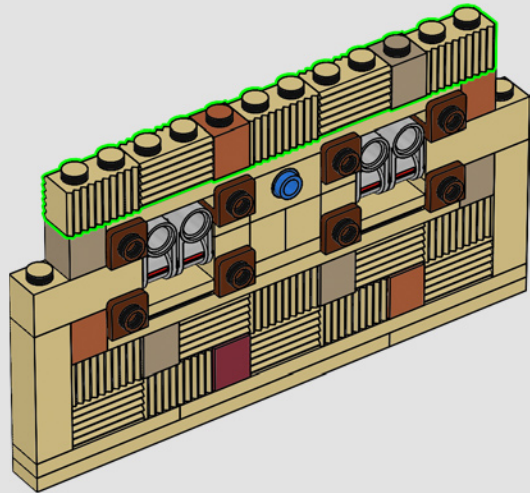

18

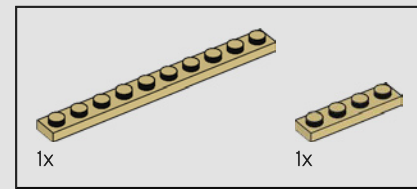
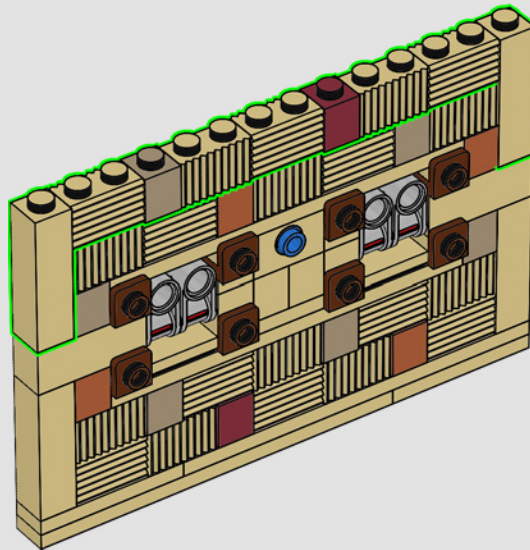

19

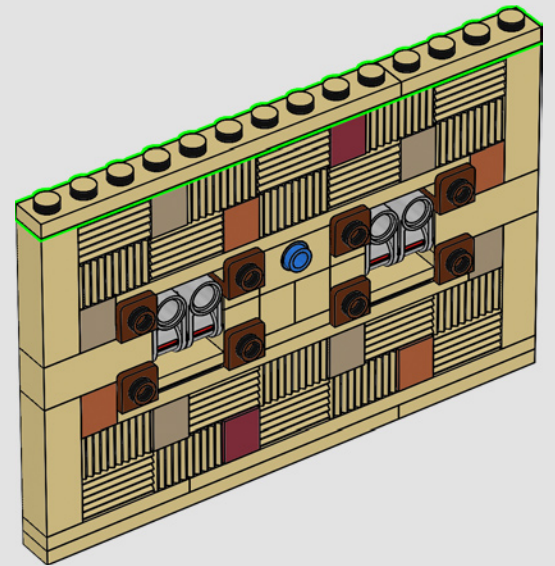

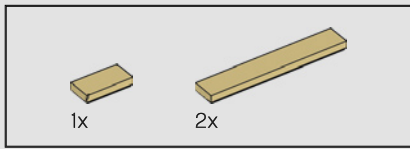

20

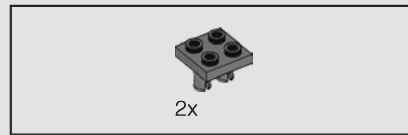
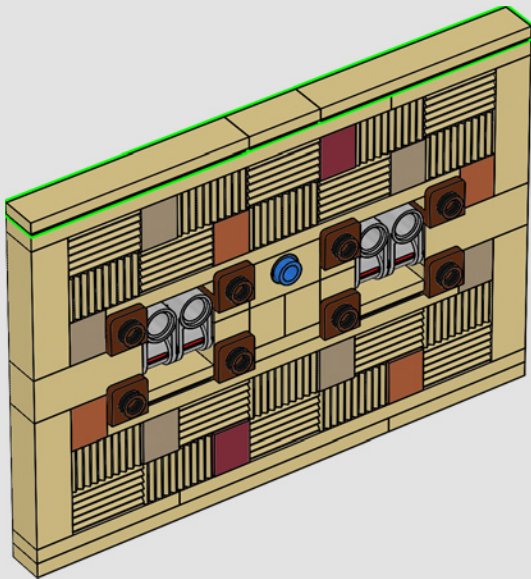

21

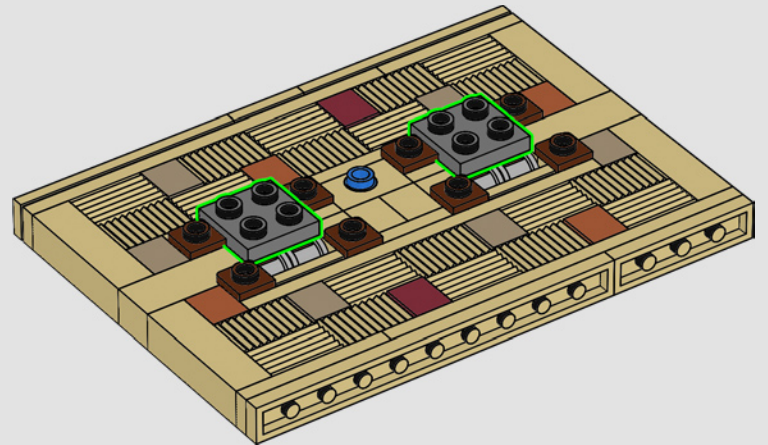
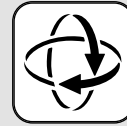



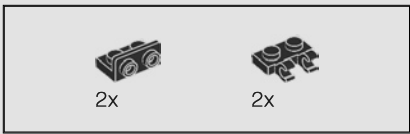

22

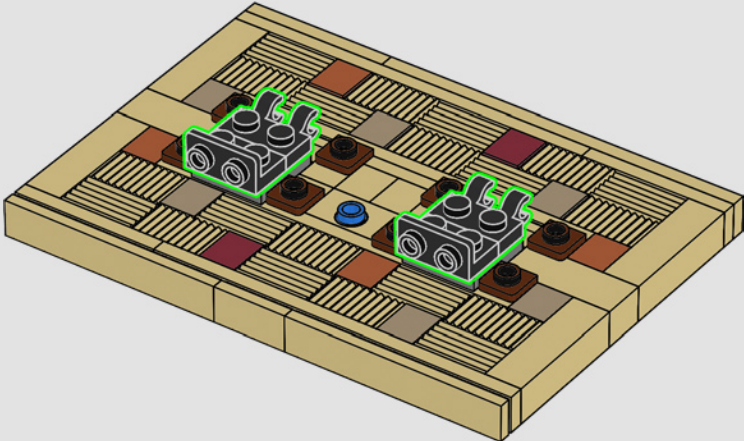

23

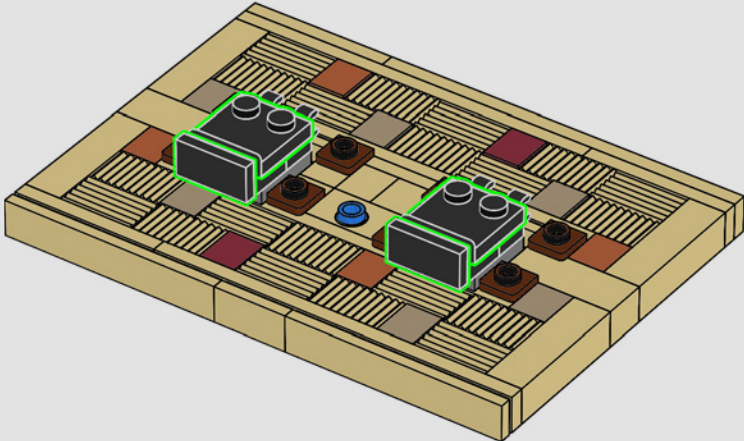

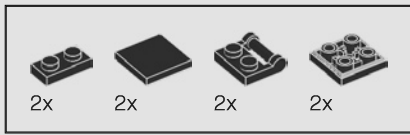

24

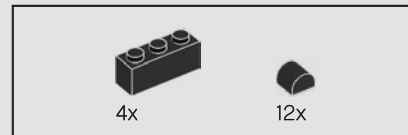
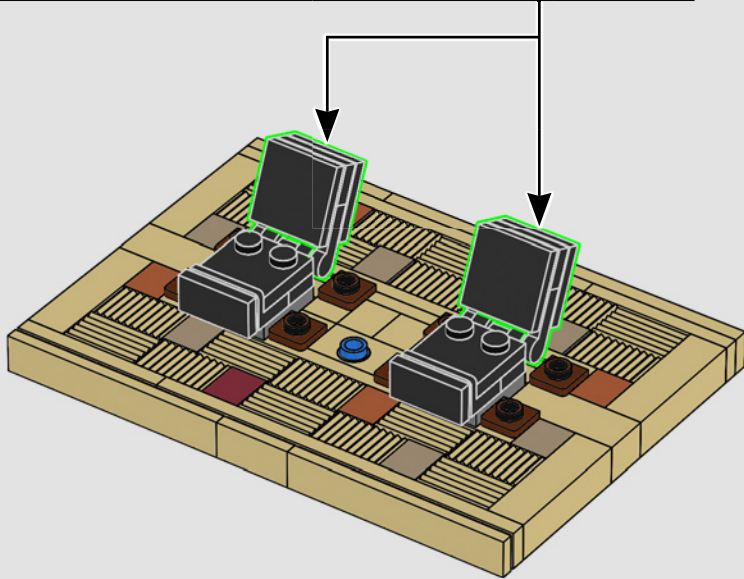
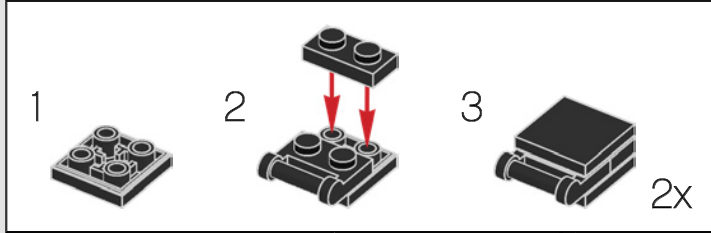

25

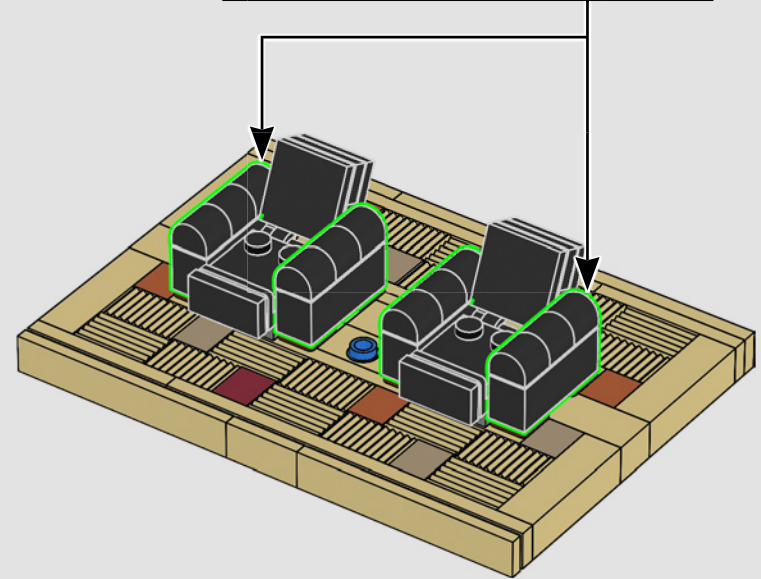
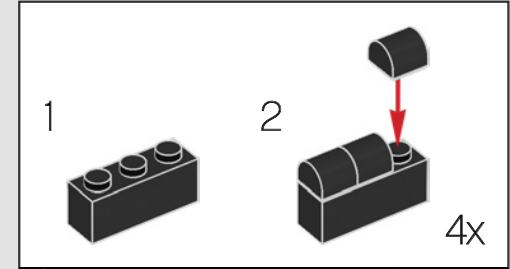

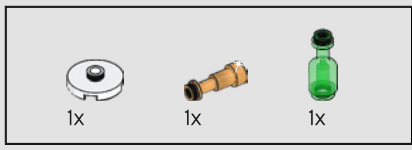

26

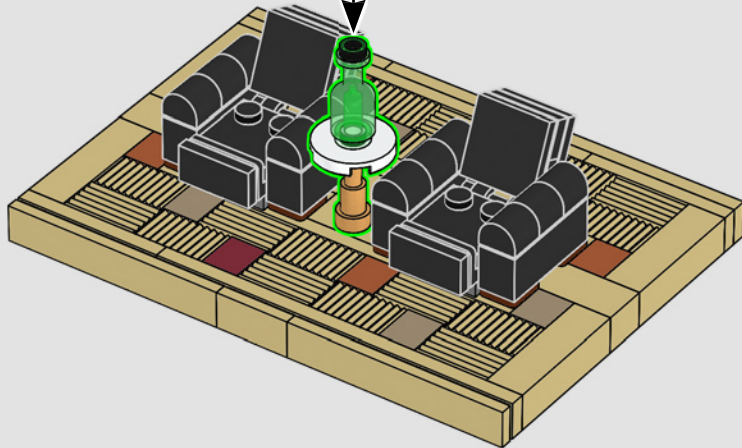
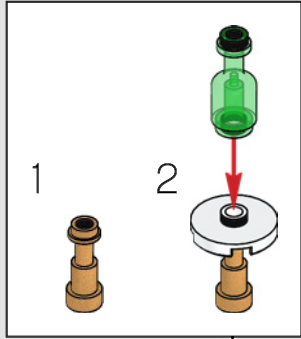

Los sillones se reclinan simultáneamente en recuerdo del momento en que ambos chicos los acaban de adquirir y deciden inclinar sus respaldos a la vez.



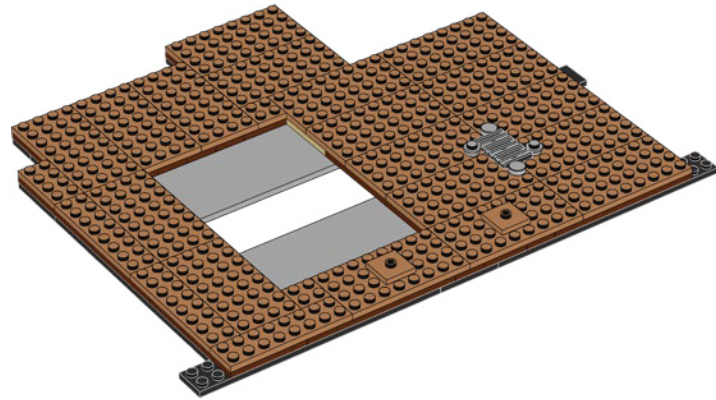

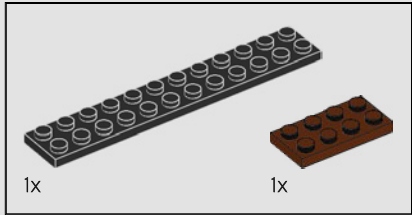
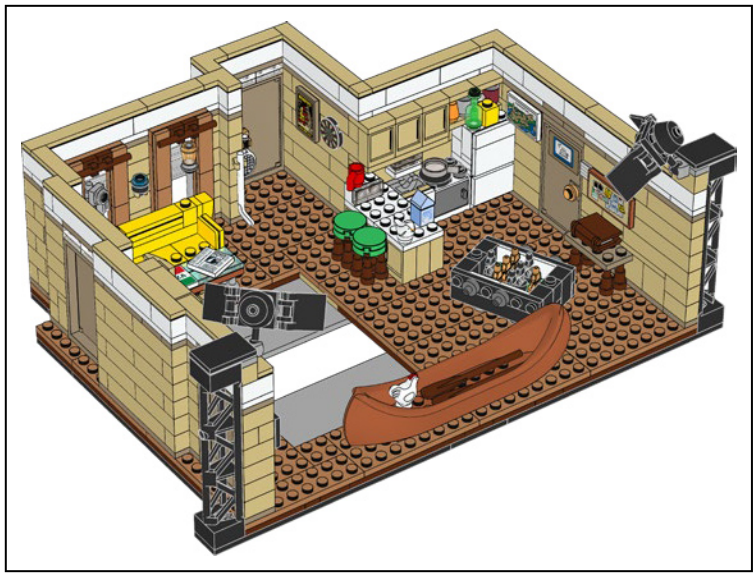

1

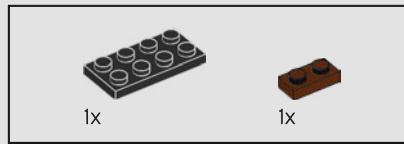
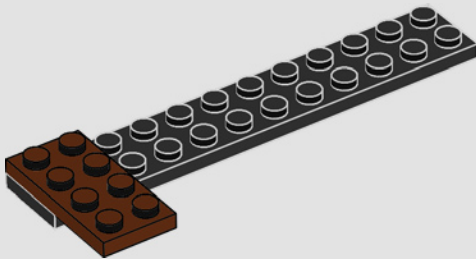

2

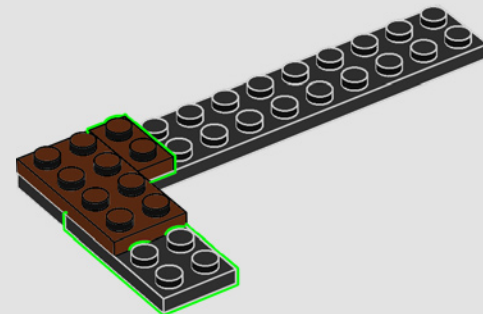



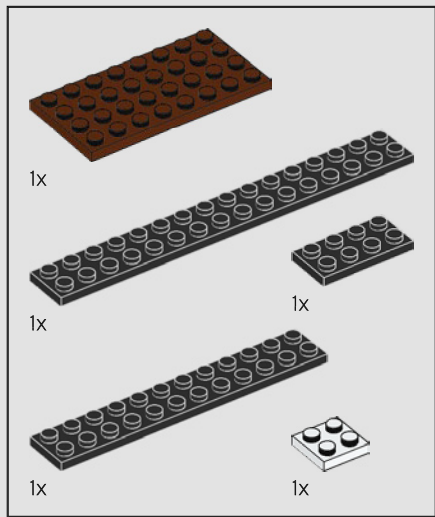

3

1

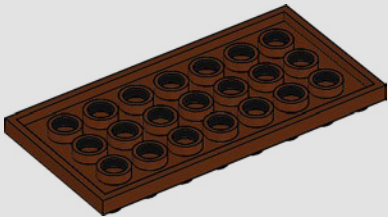

2

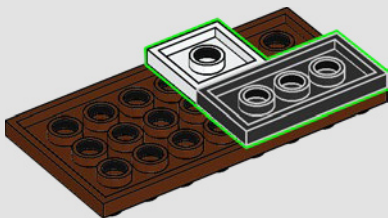

3

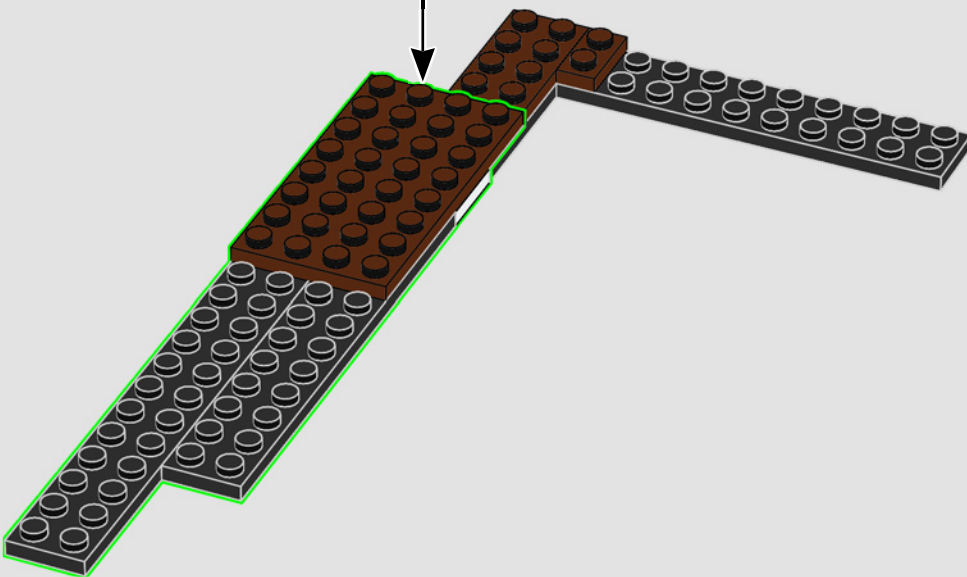
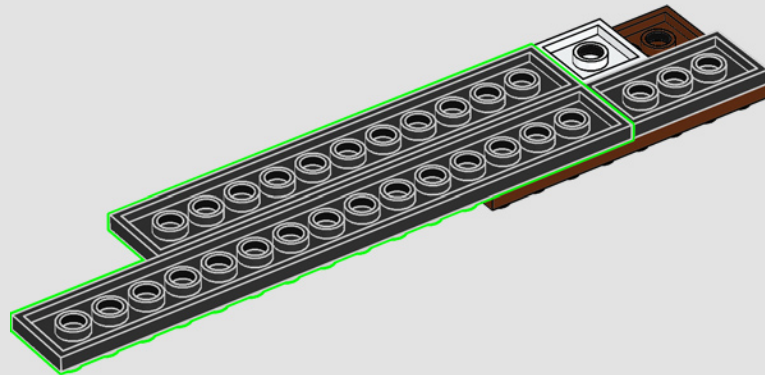



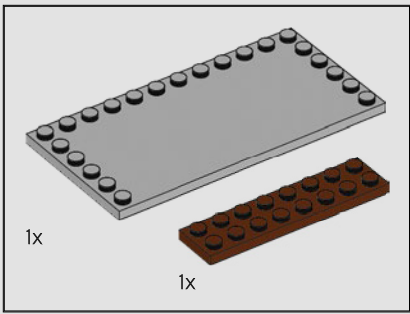

4

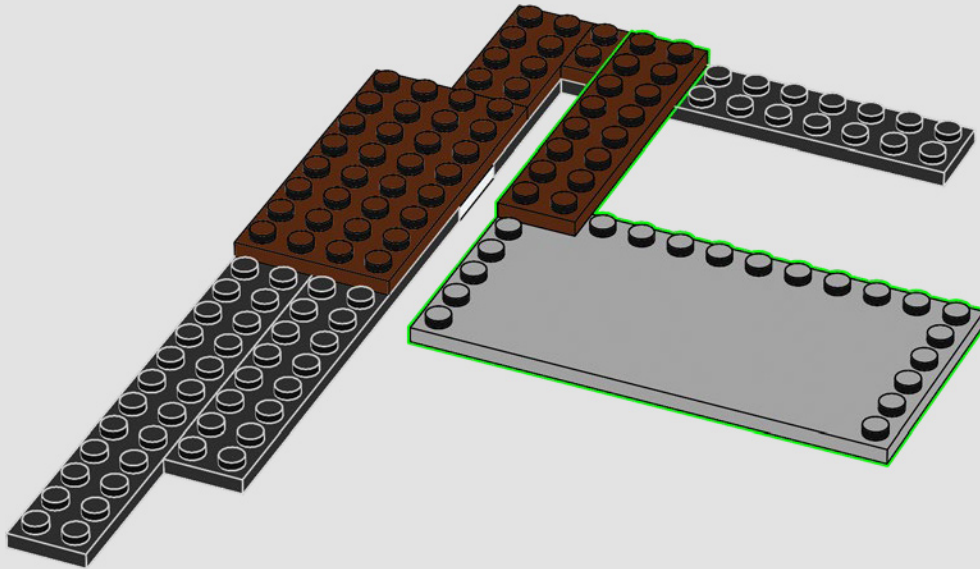

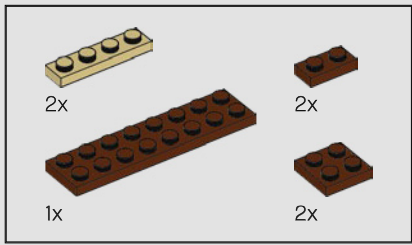

5

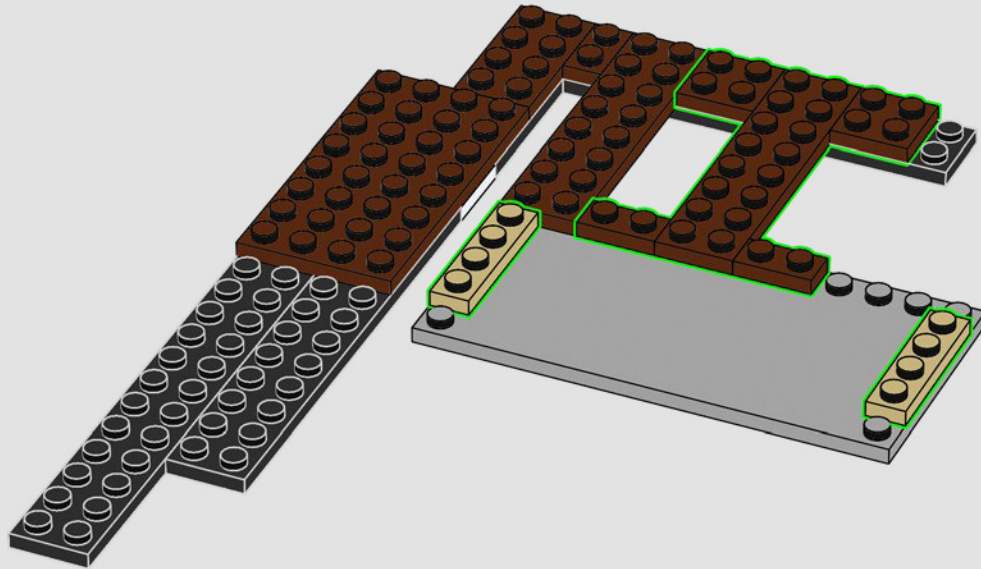

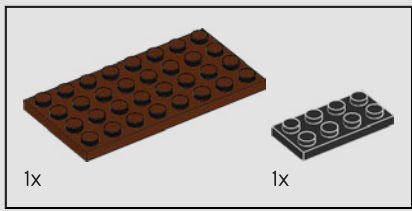

6

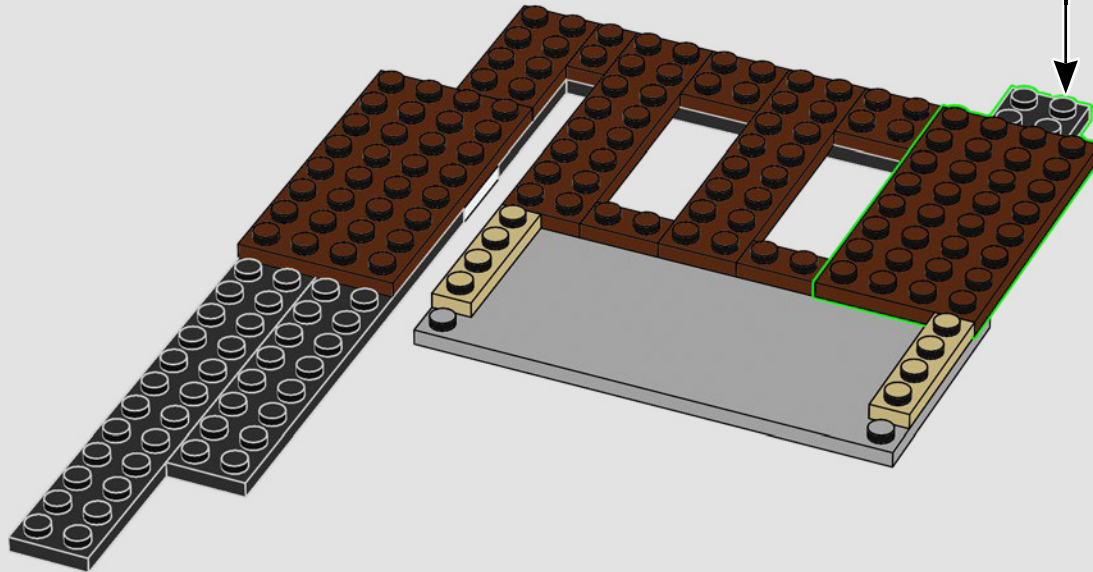
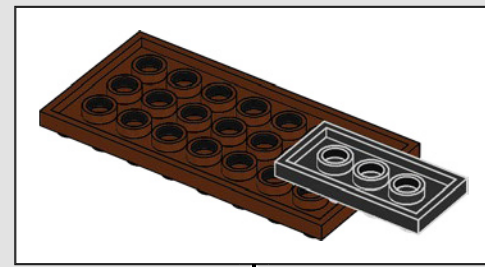

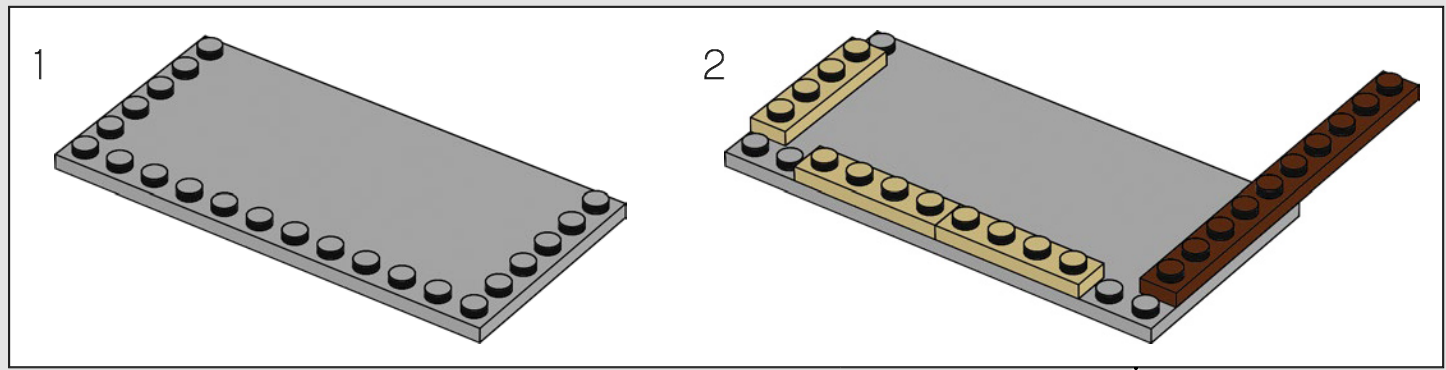
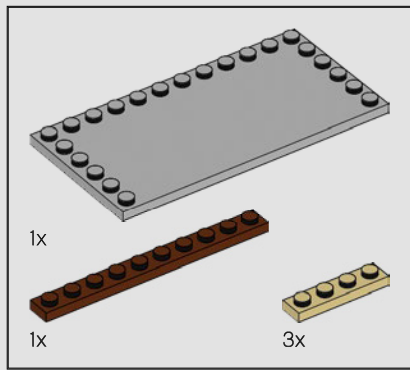

7

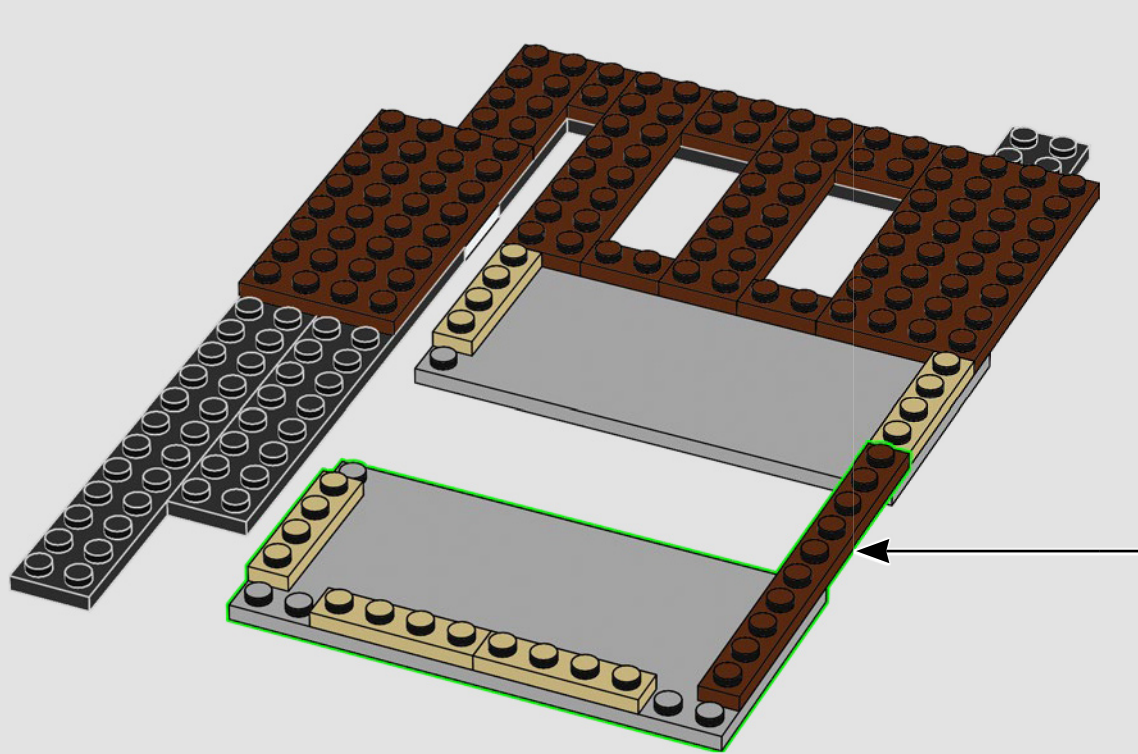

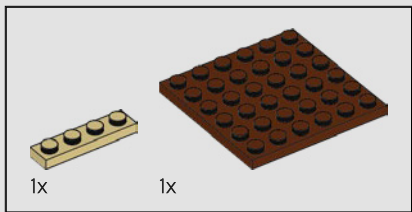

8

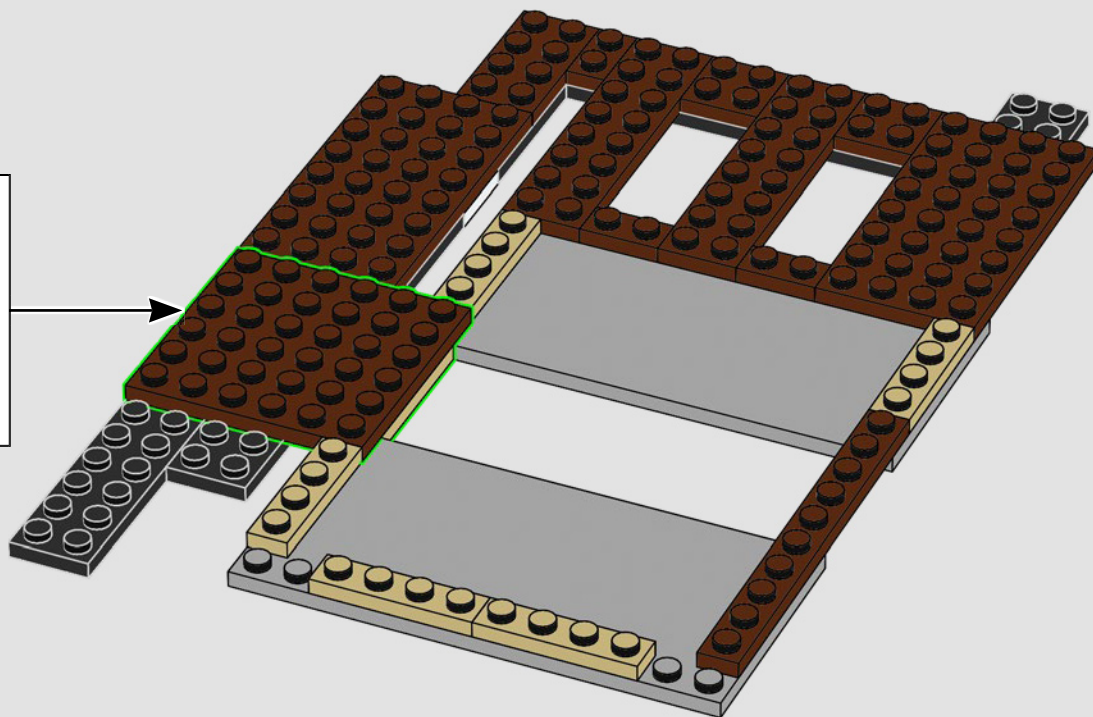



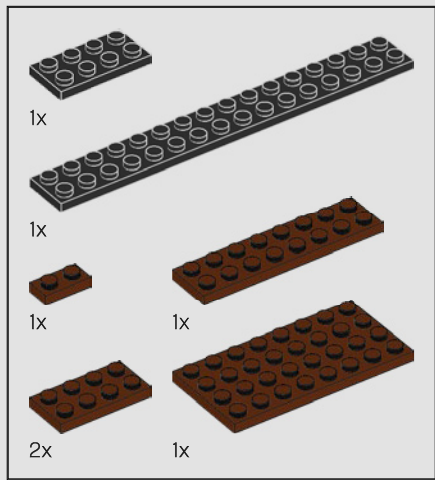

9

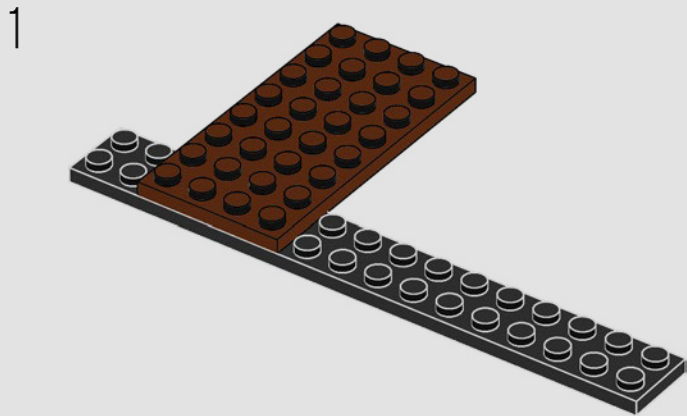

2

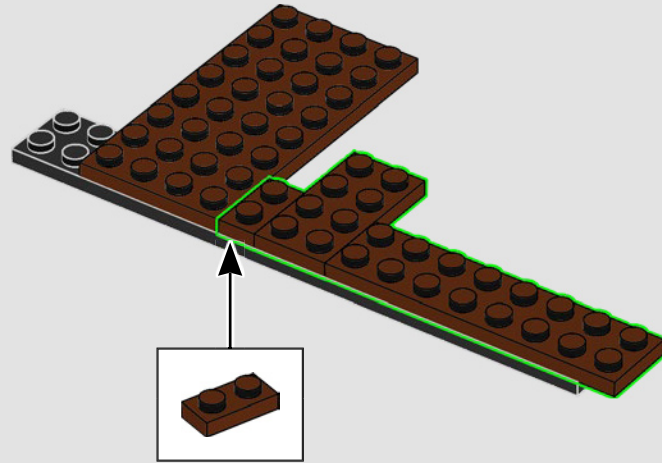

3

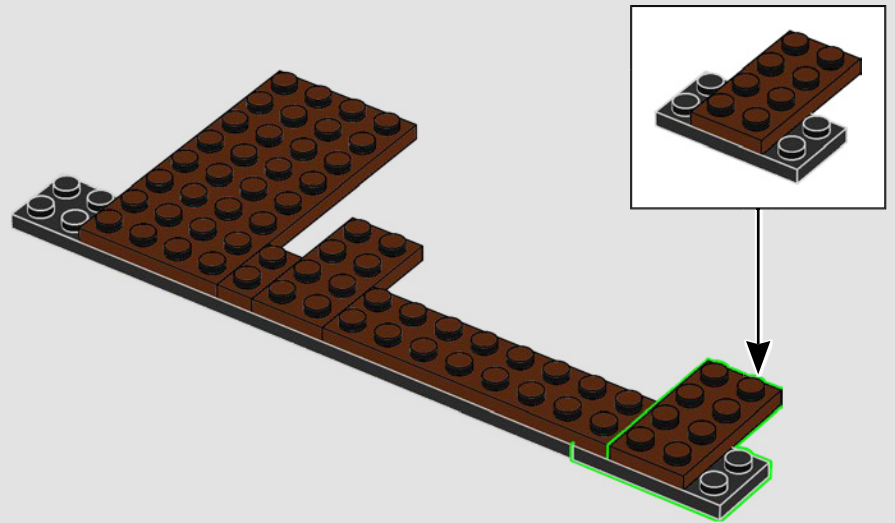



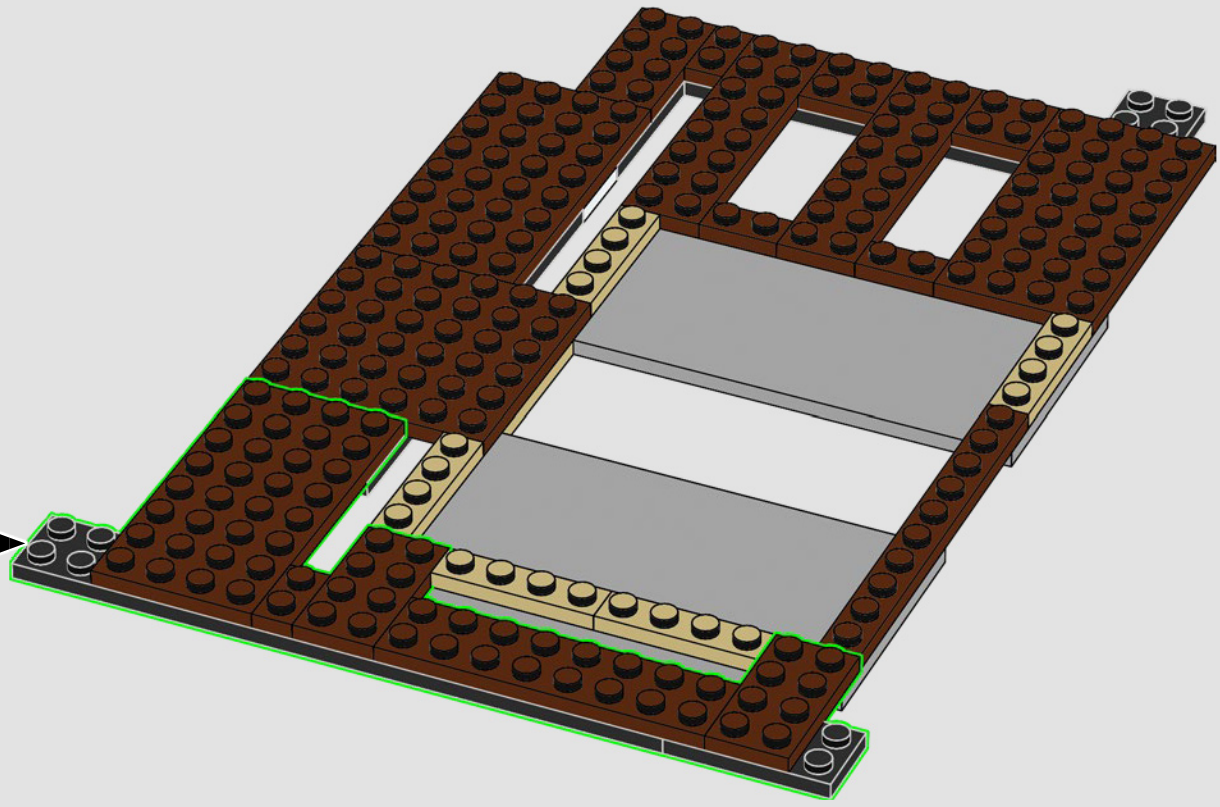

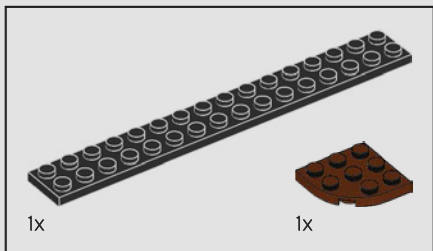

10

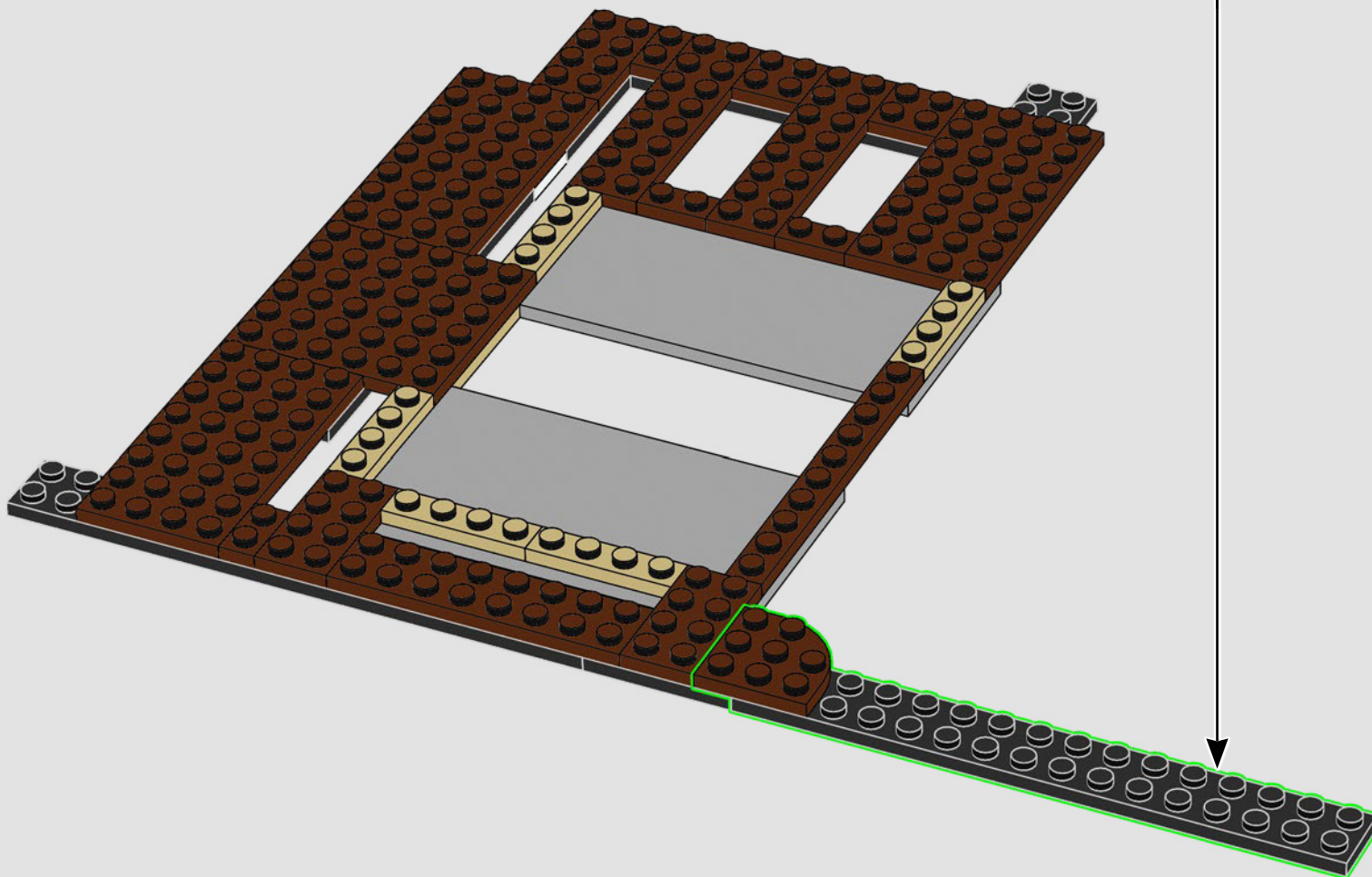
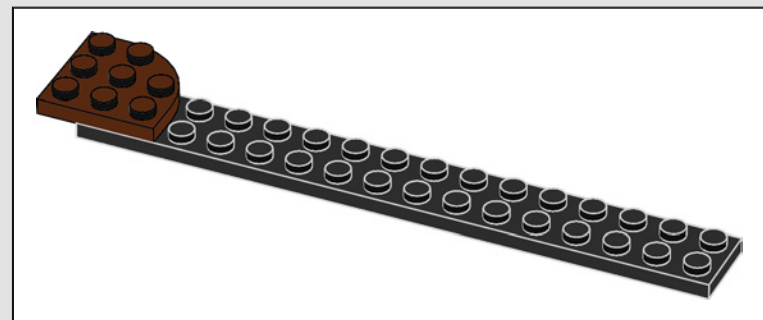

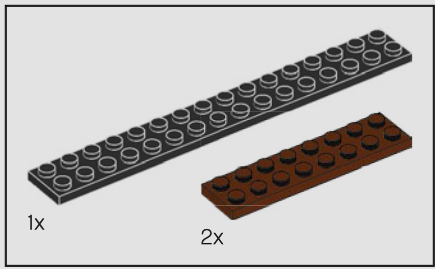

11

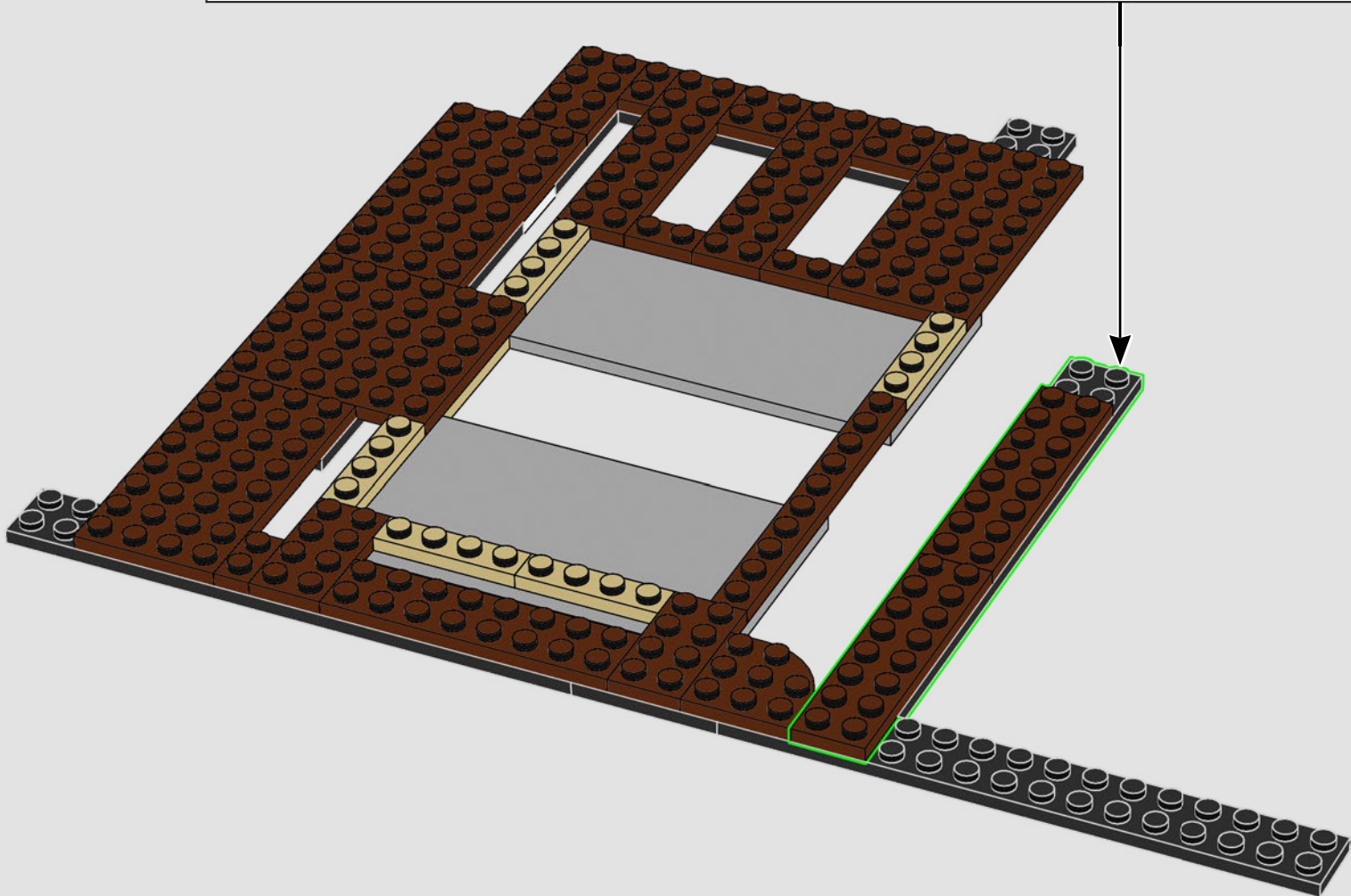
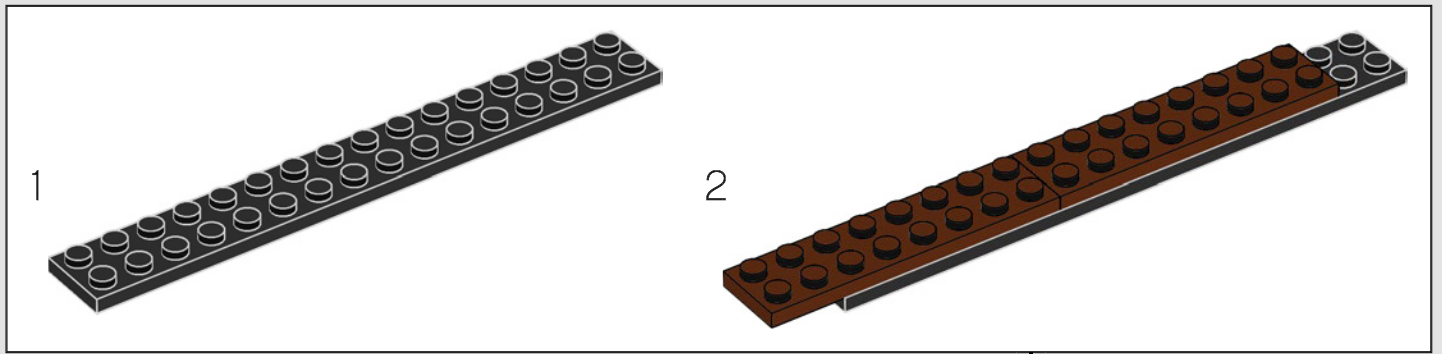

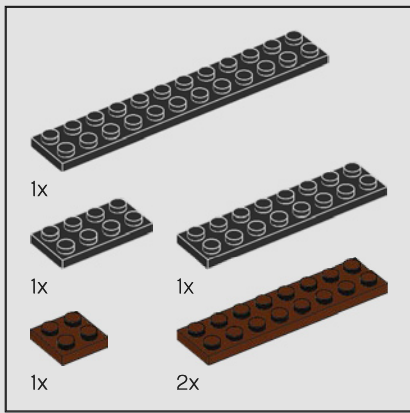

12

1

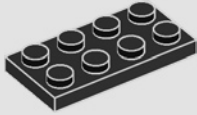

2

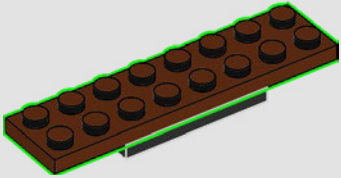

3

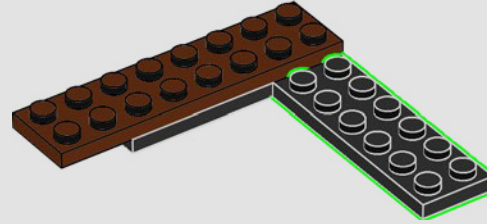

4

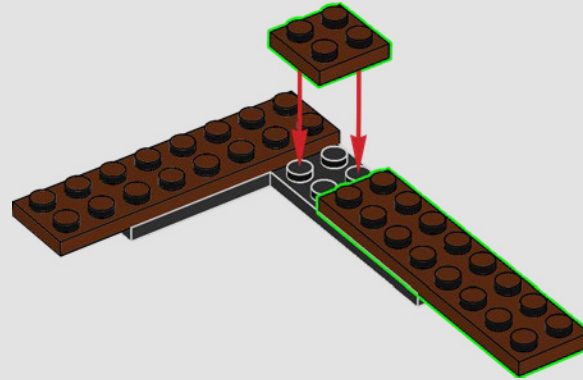

5

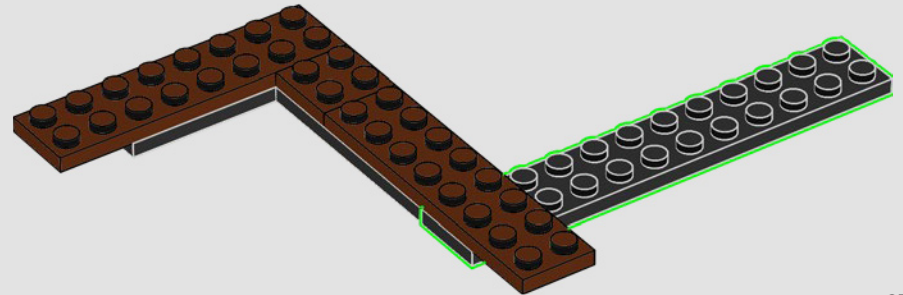



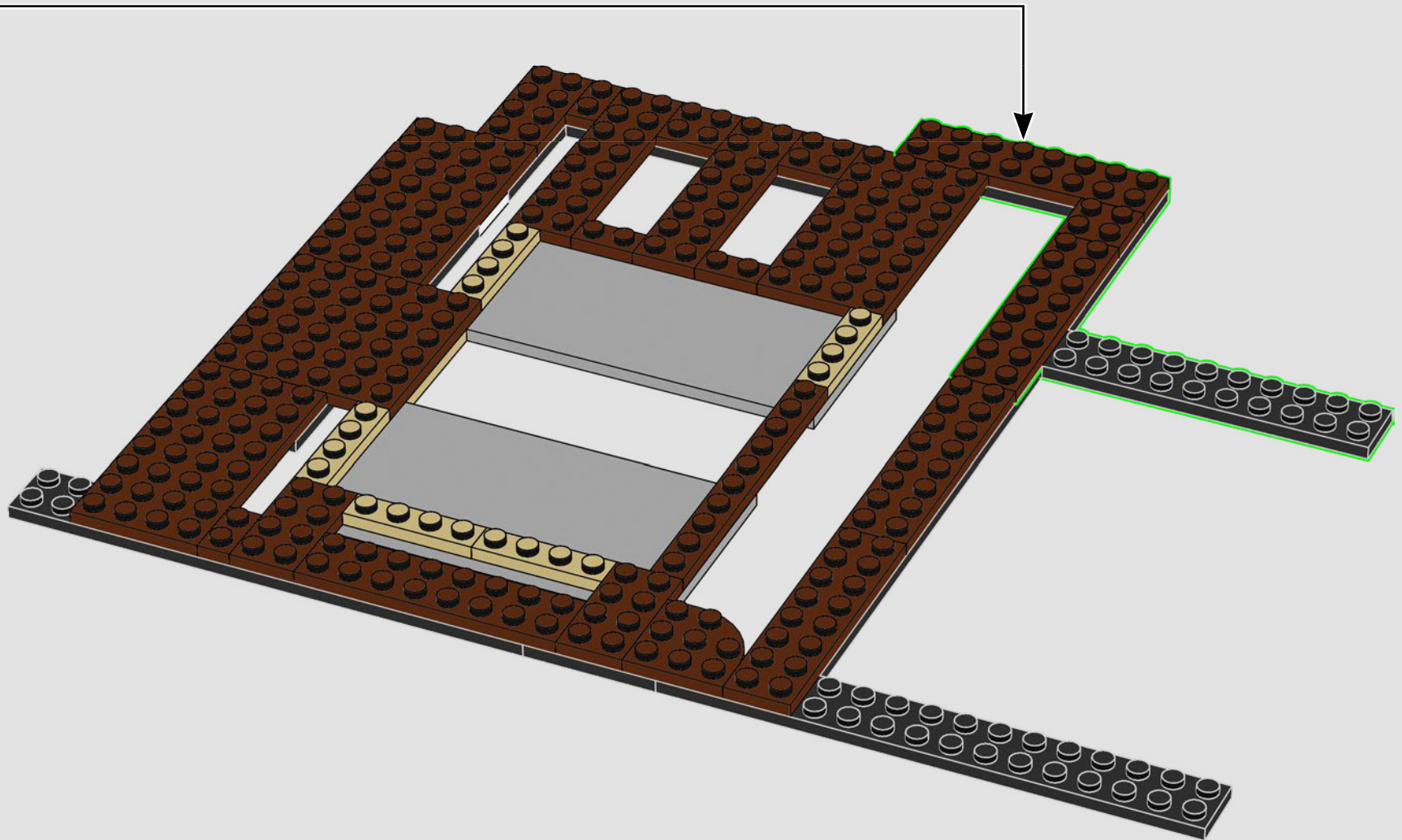

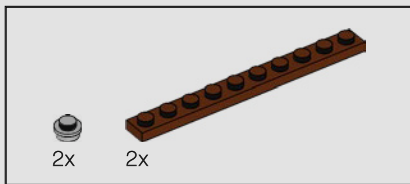

13

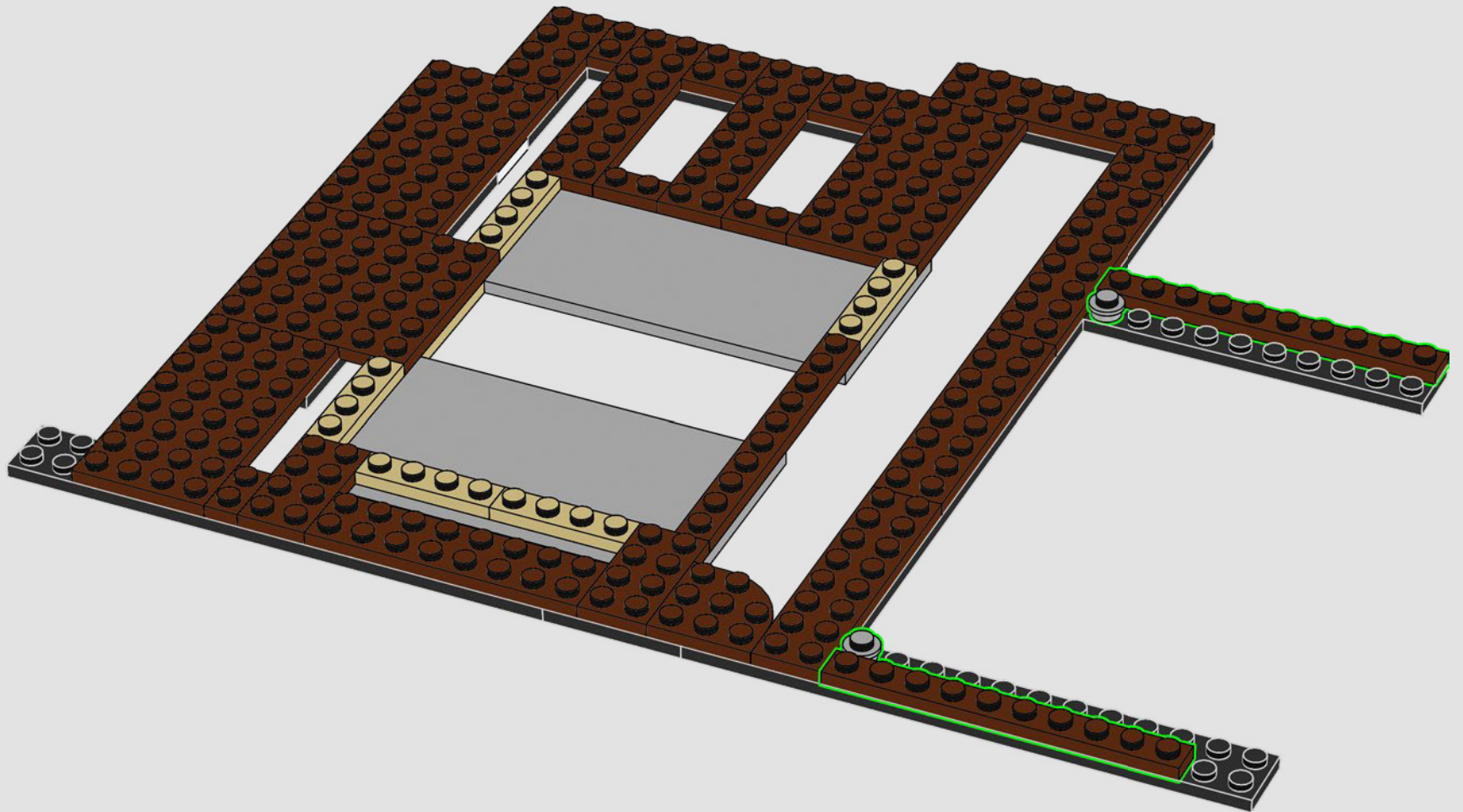



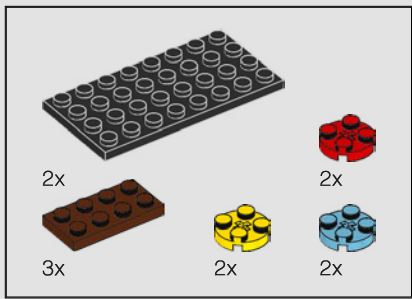

14

1

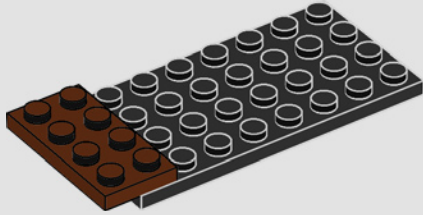

2

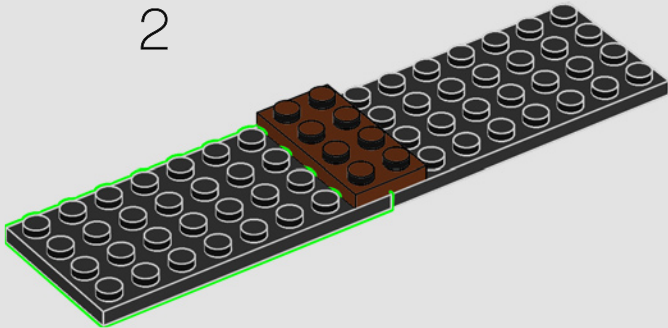

3

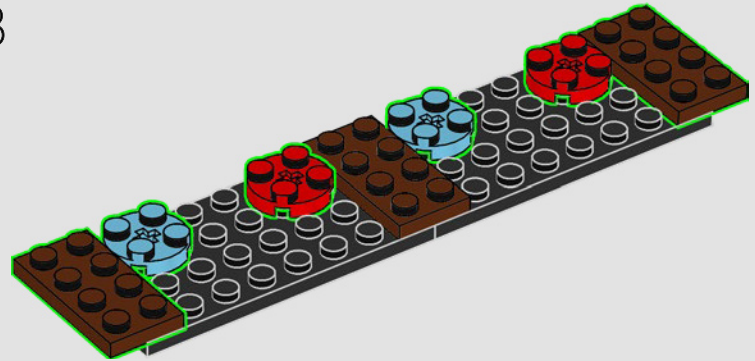

4

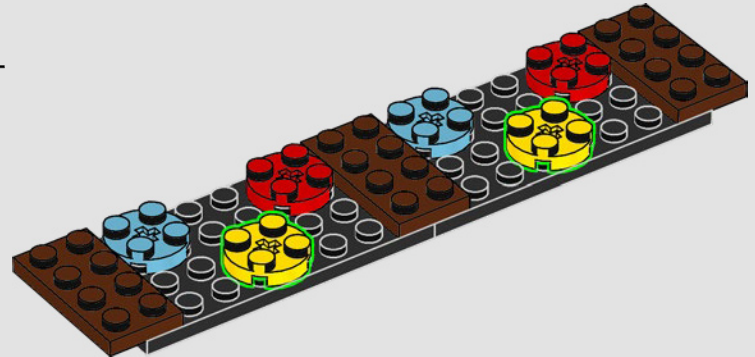

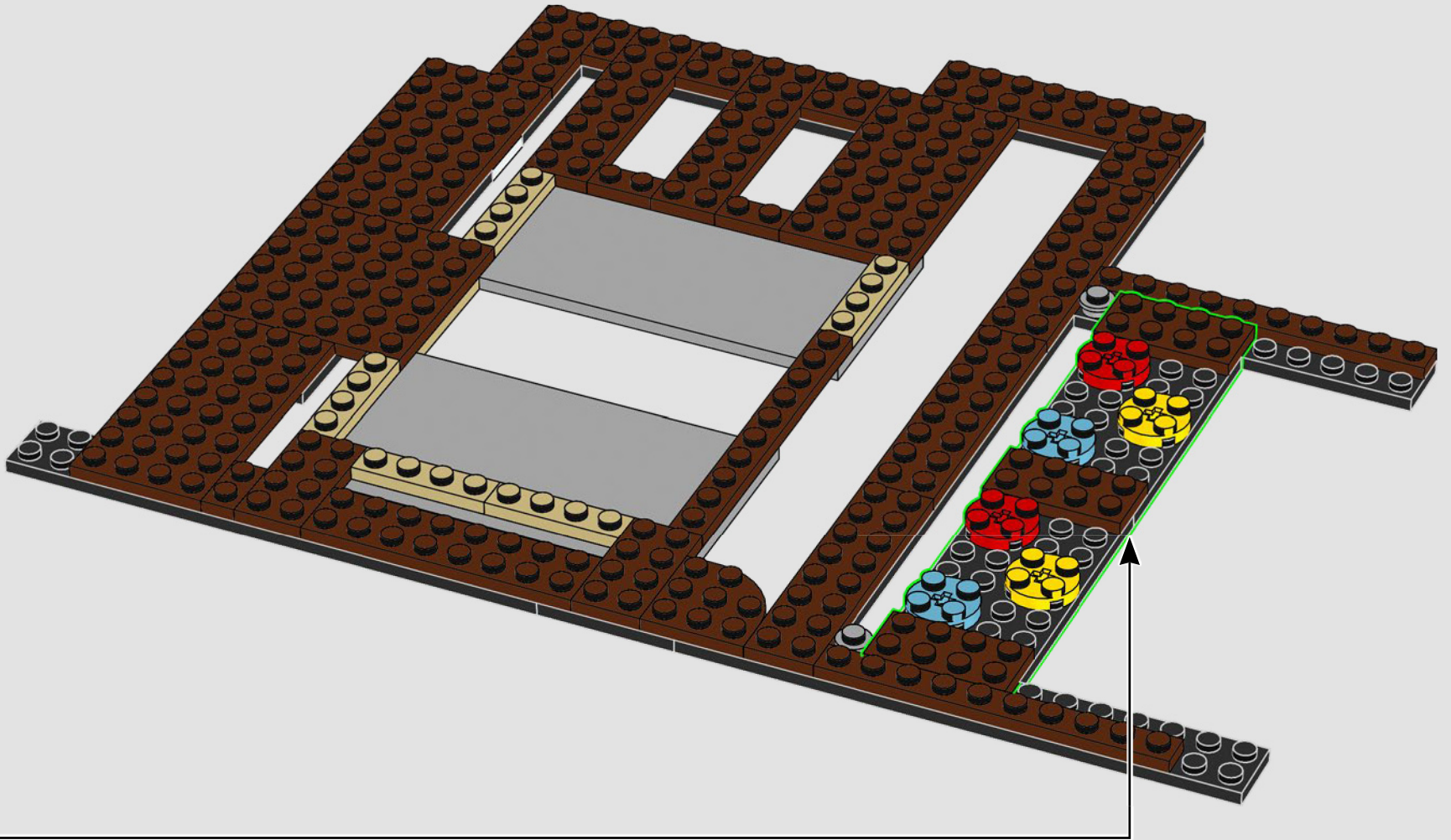

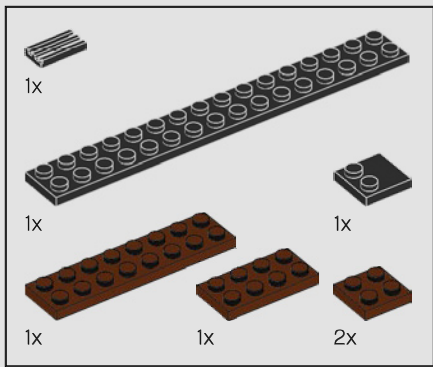

15

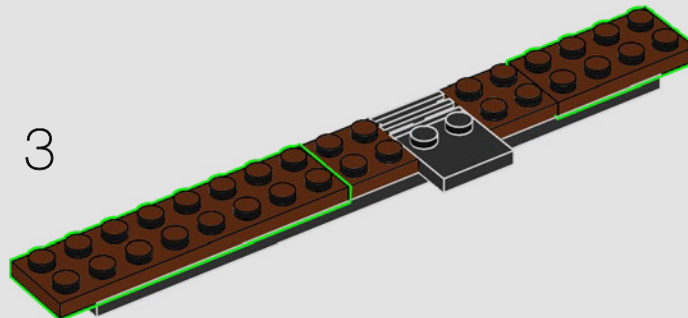
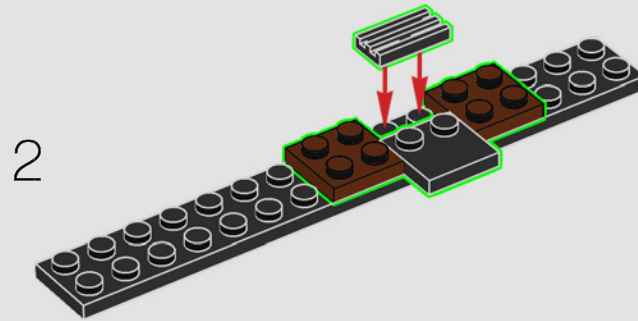
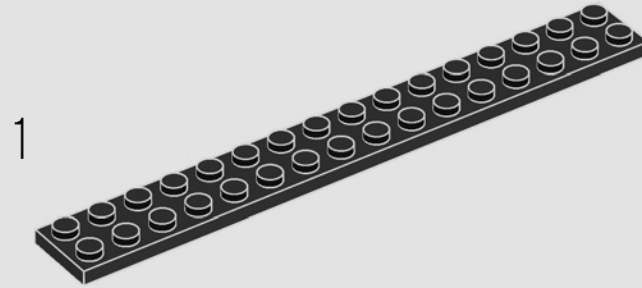

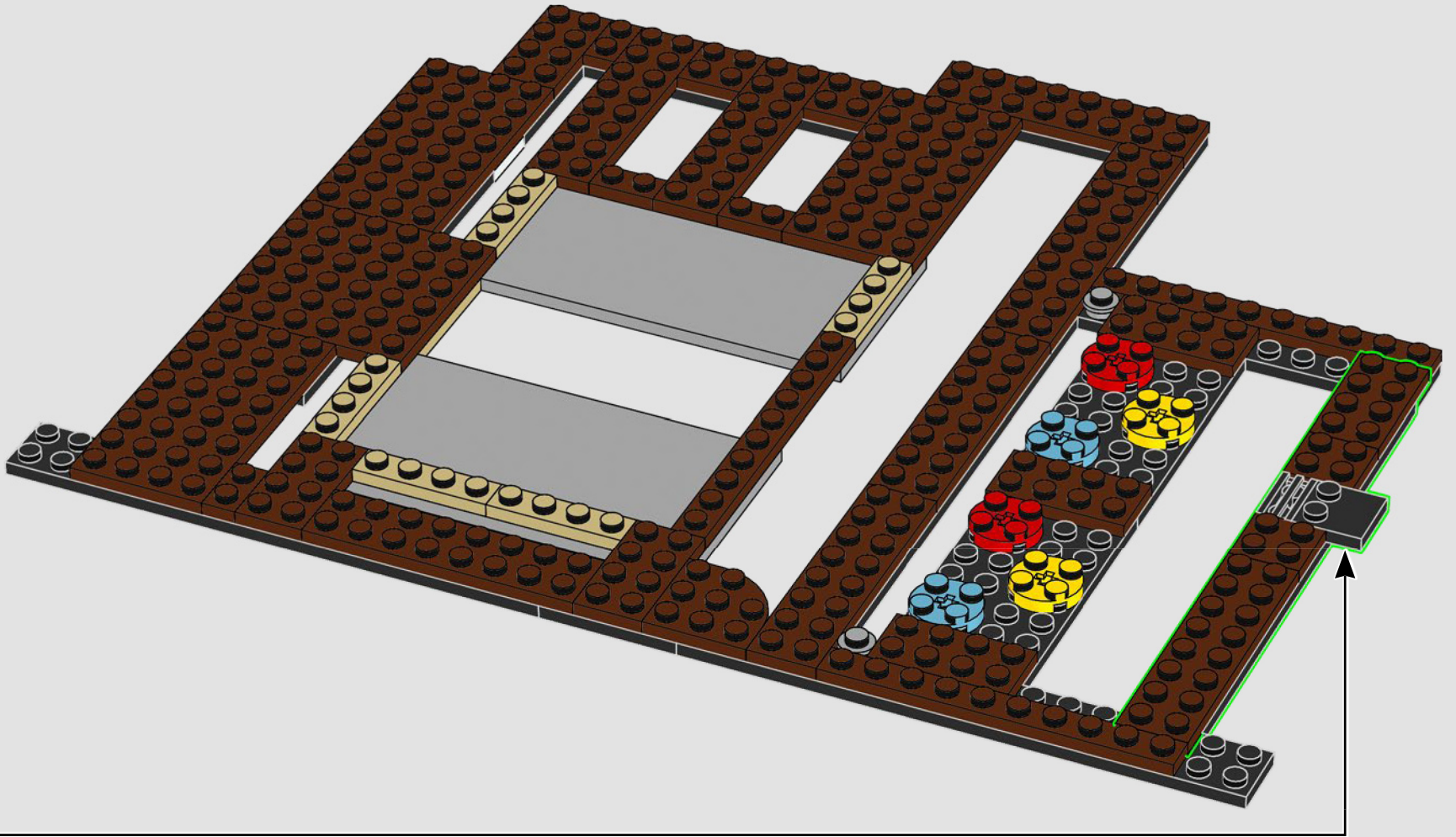



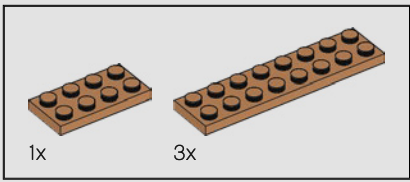

16

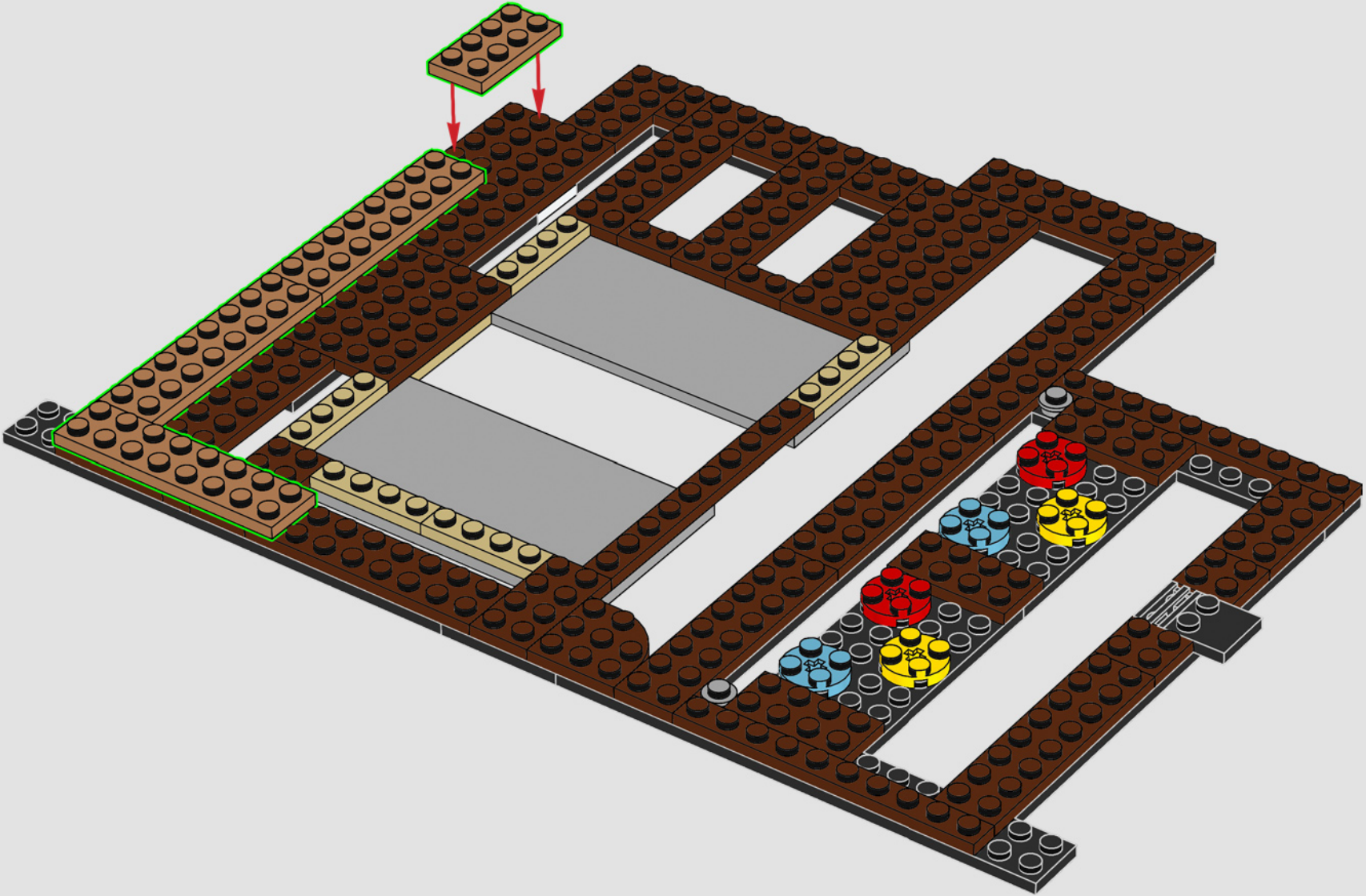



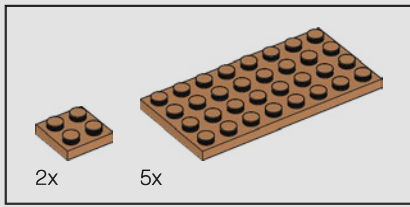

17

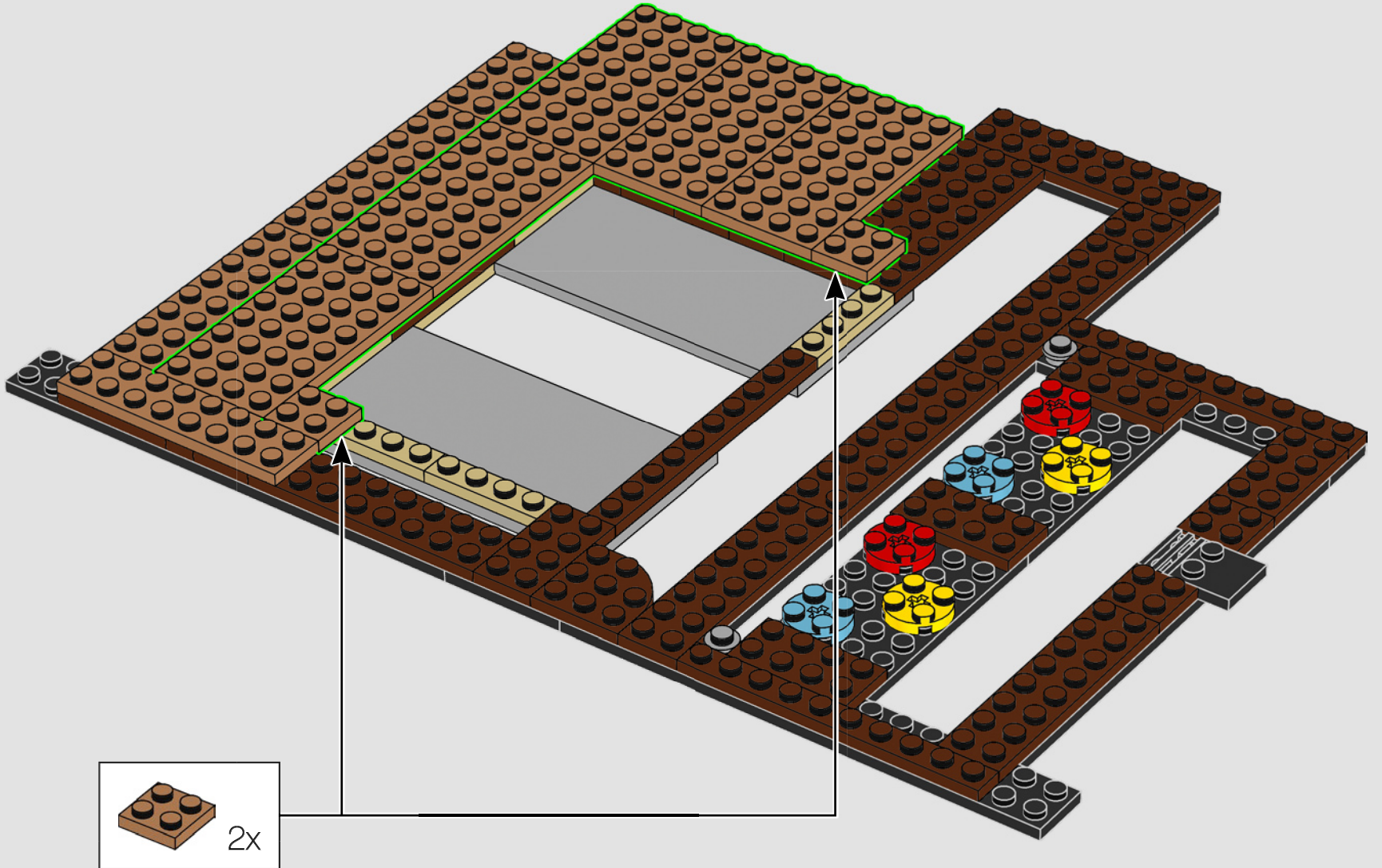

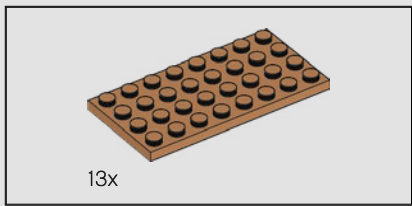

18

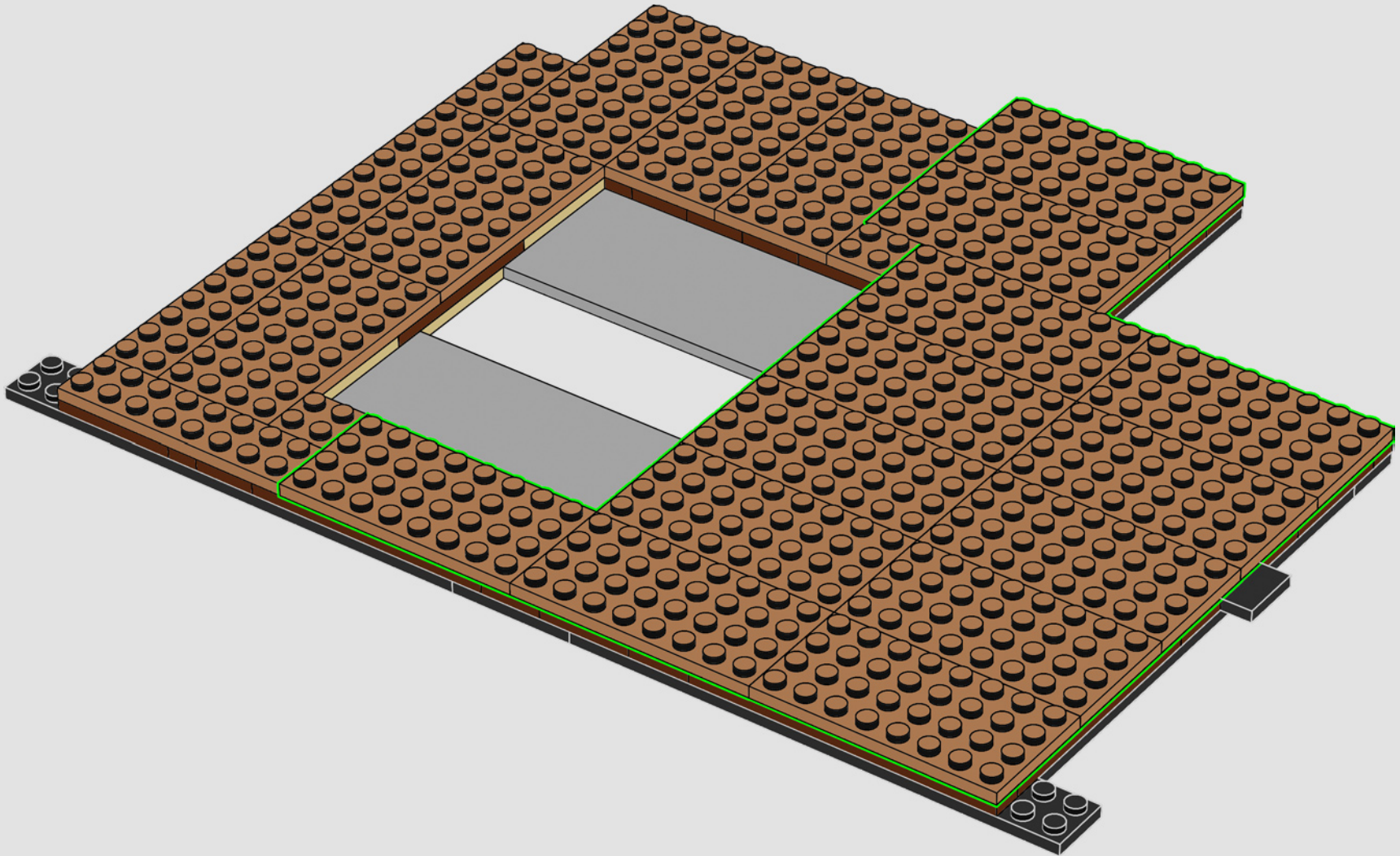



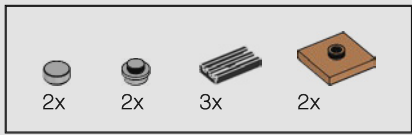

19

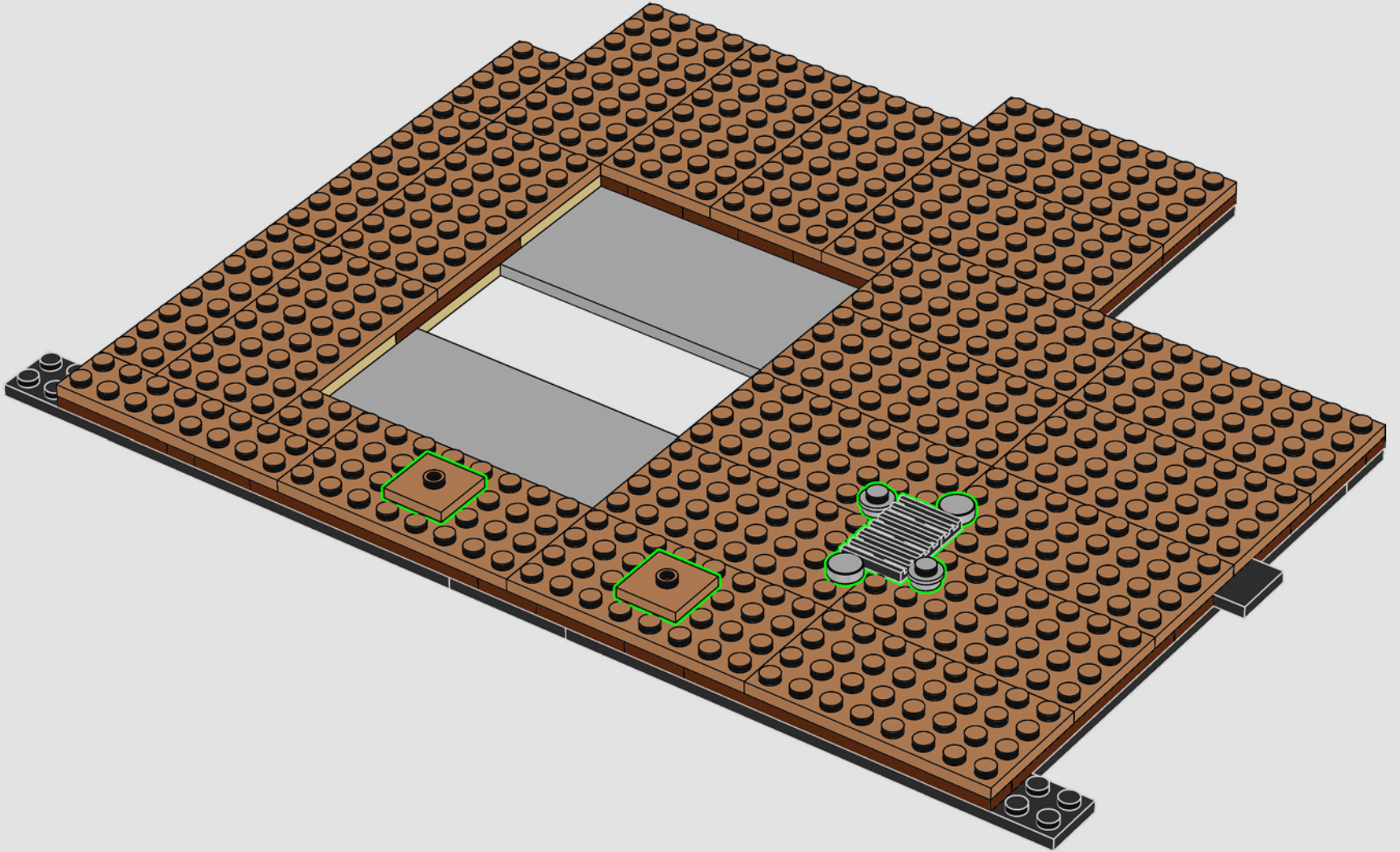

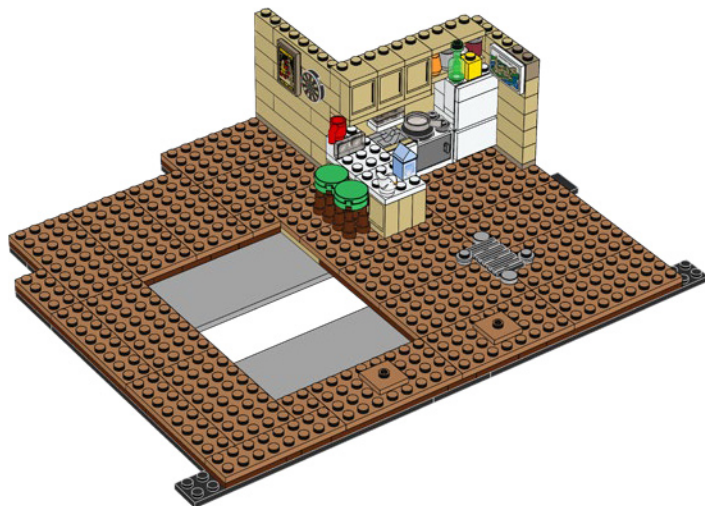

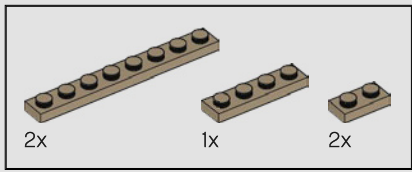

20

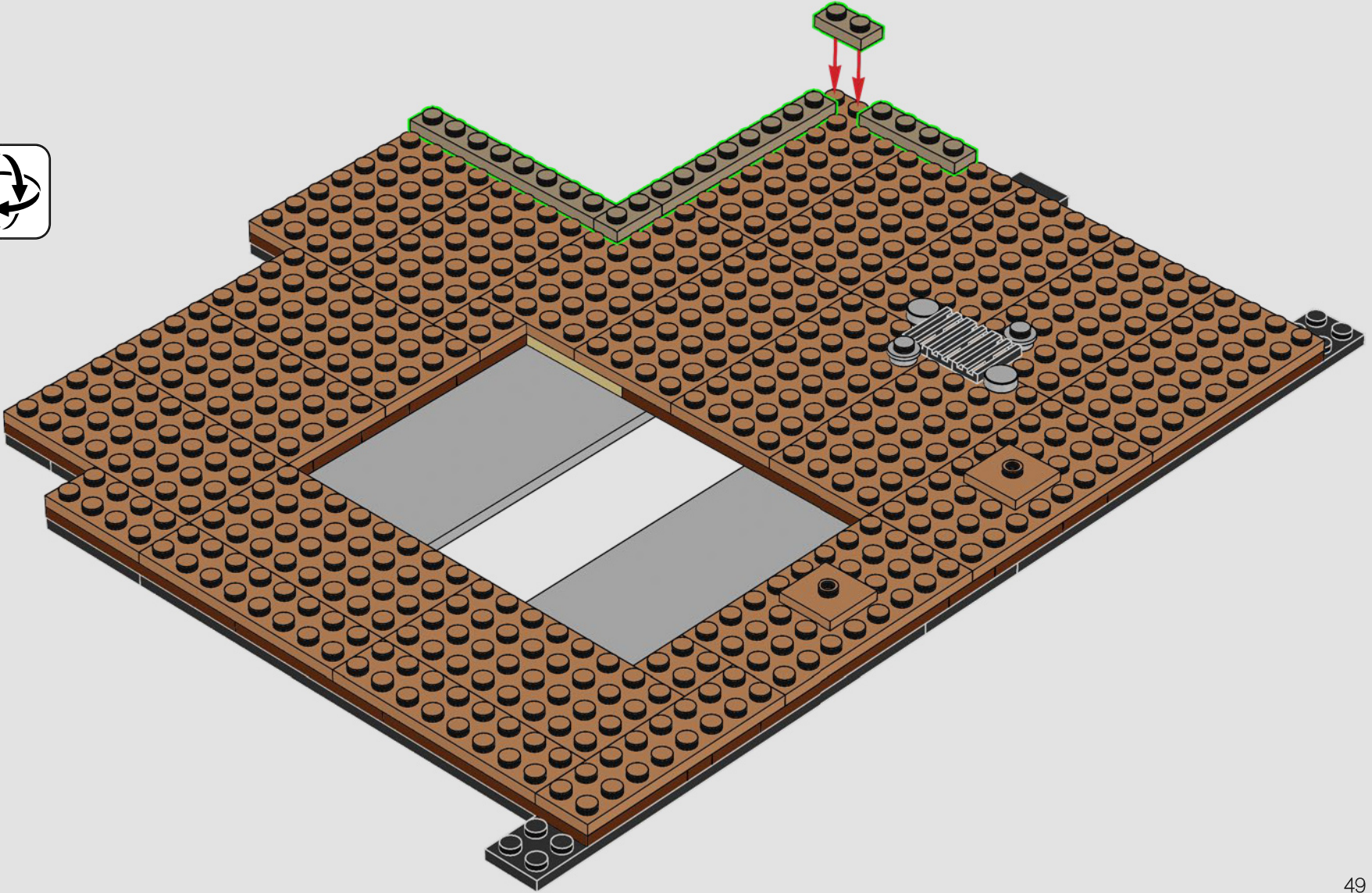



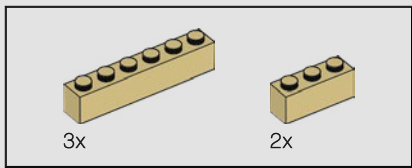

21

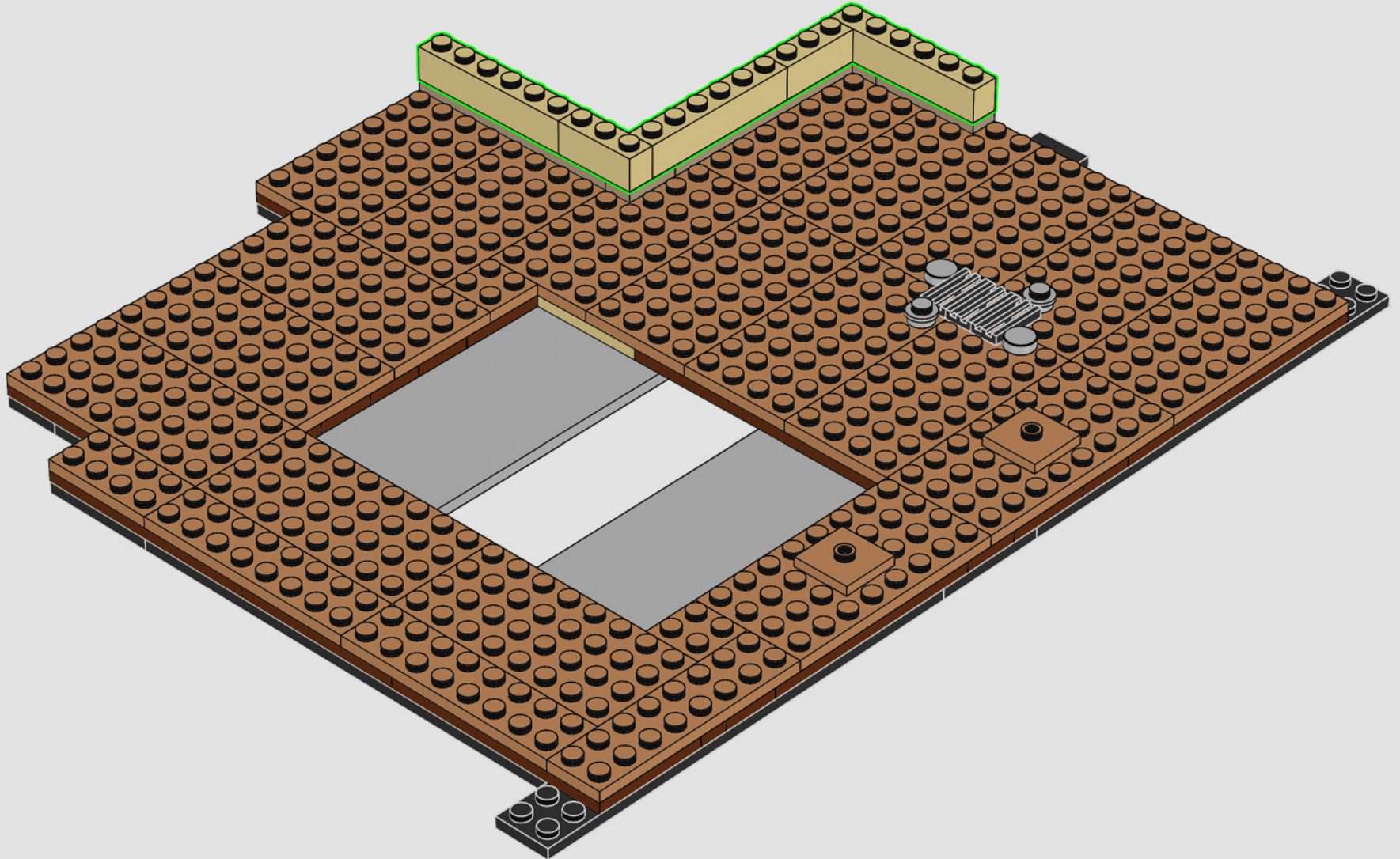

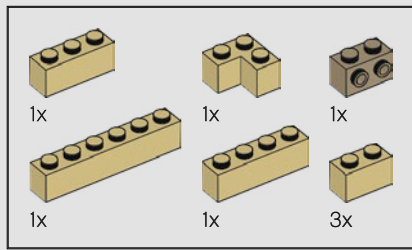

22

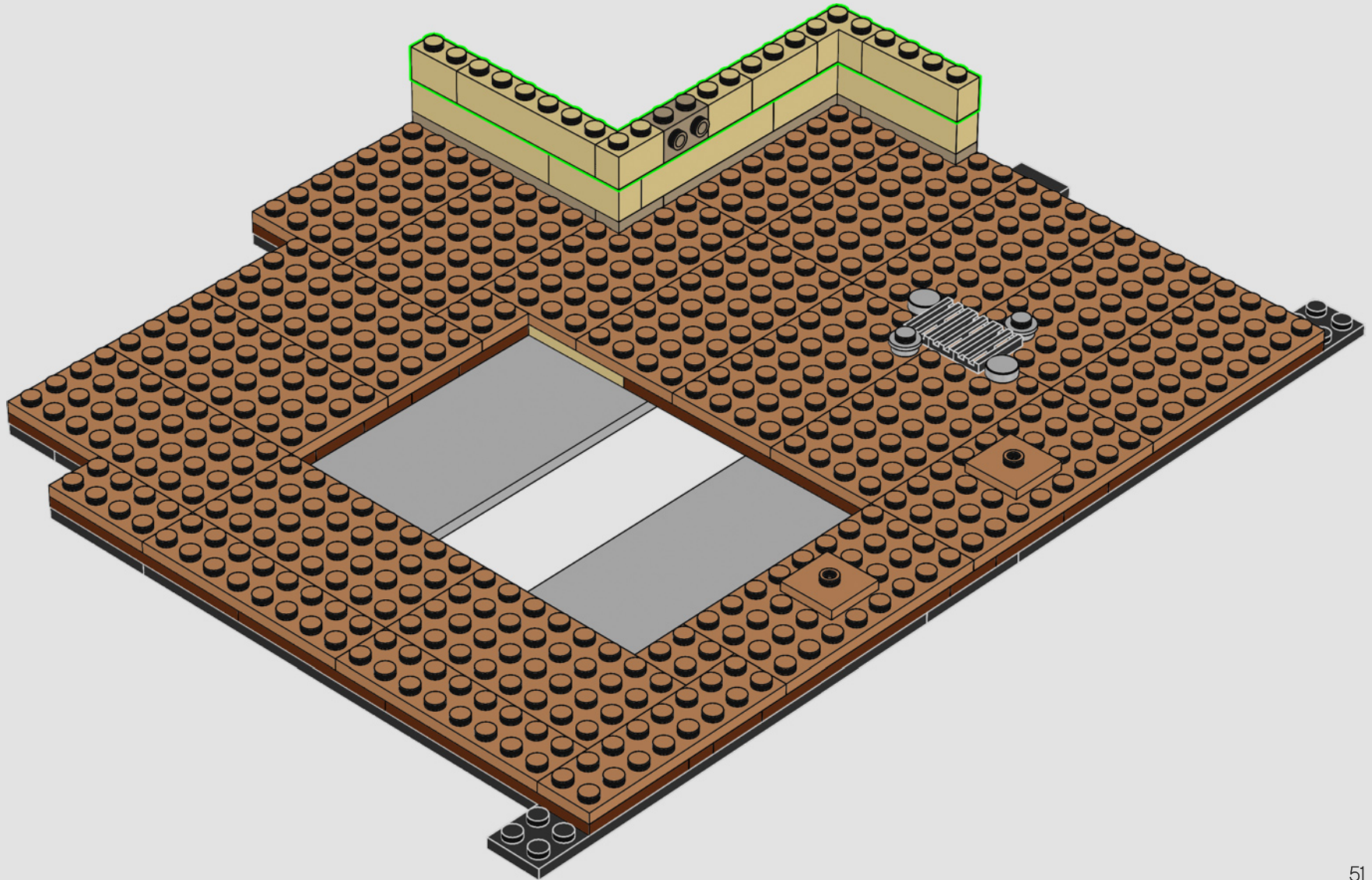



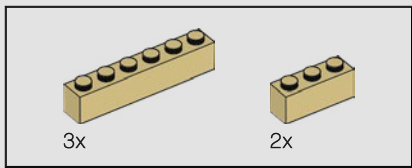

23

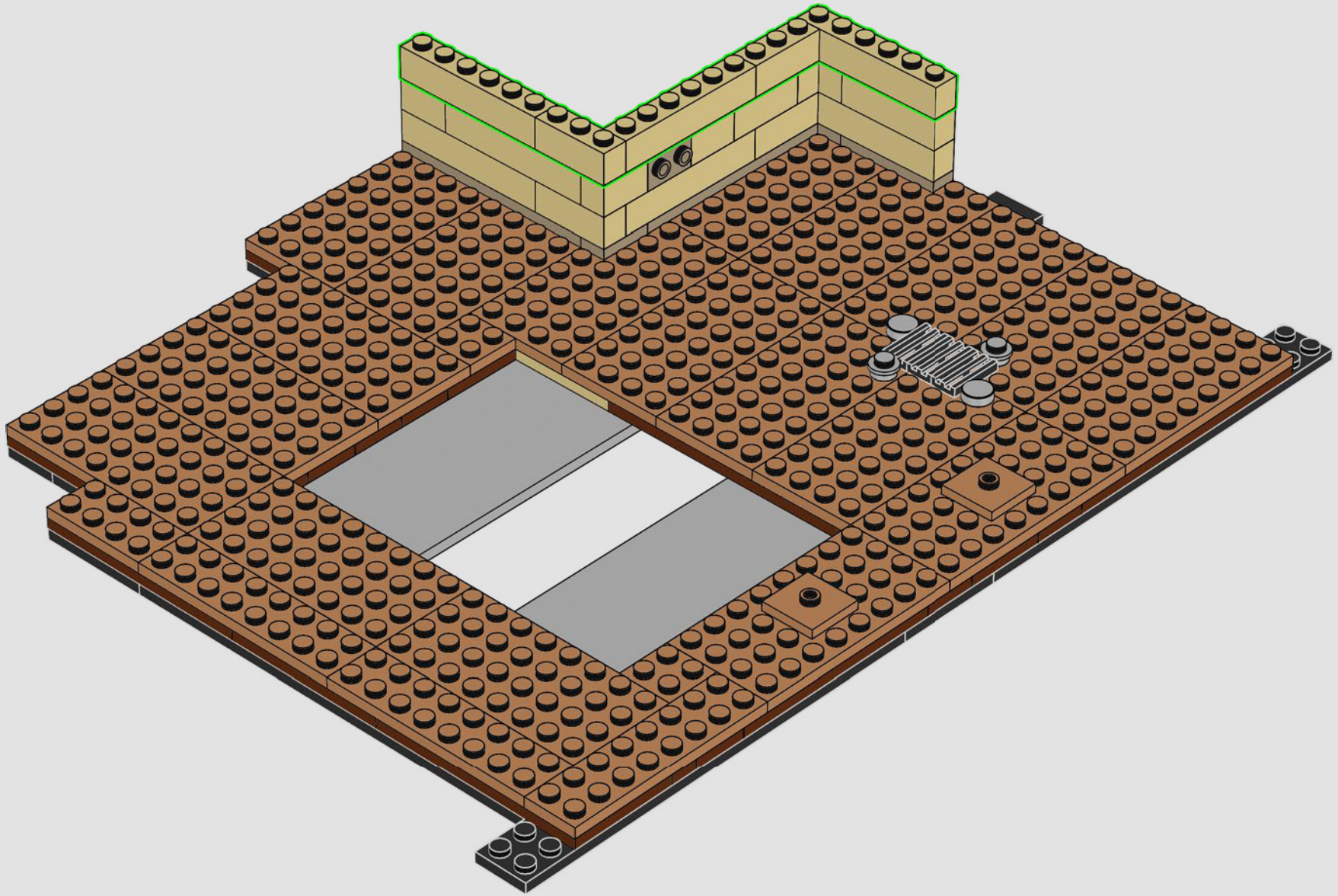

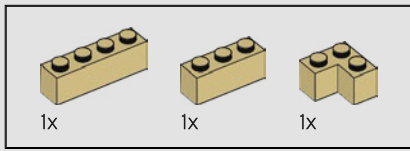

24

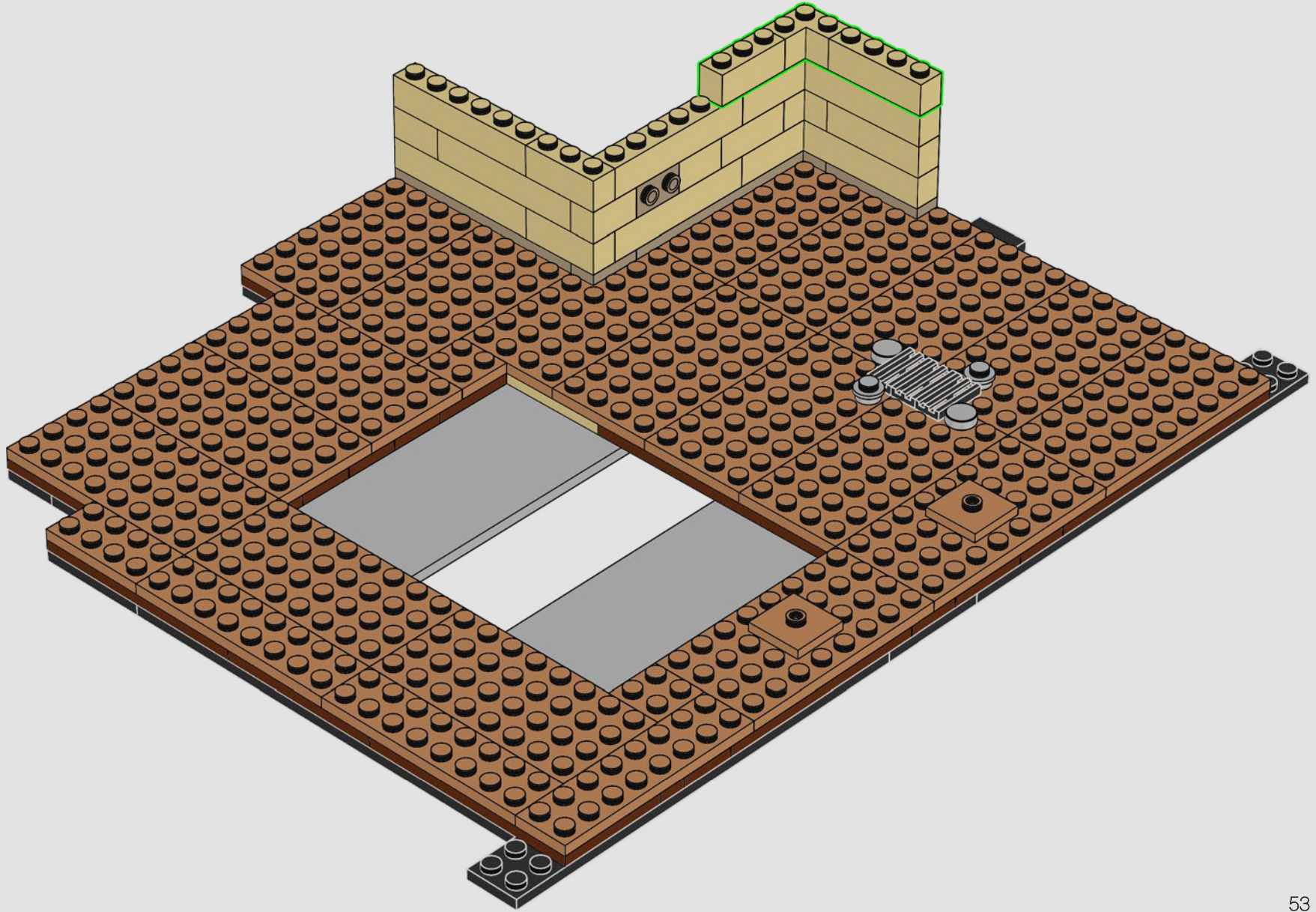



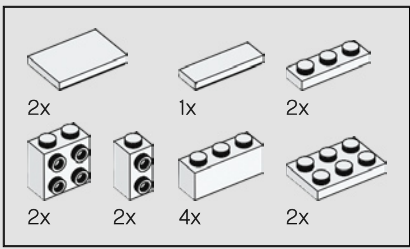

25

1



2

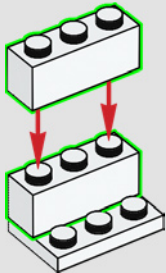

3

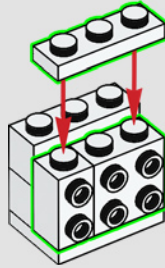

4

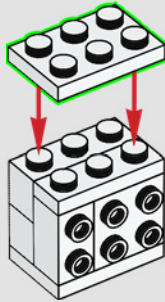

5

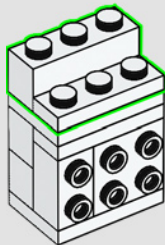

6

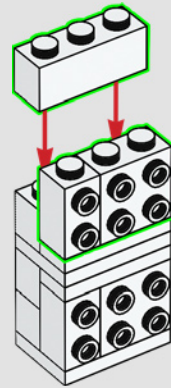

7

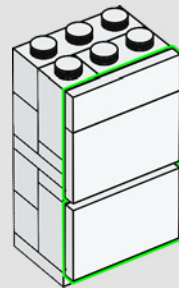



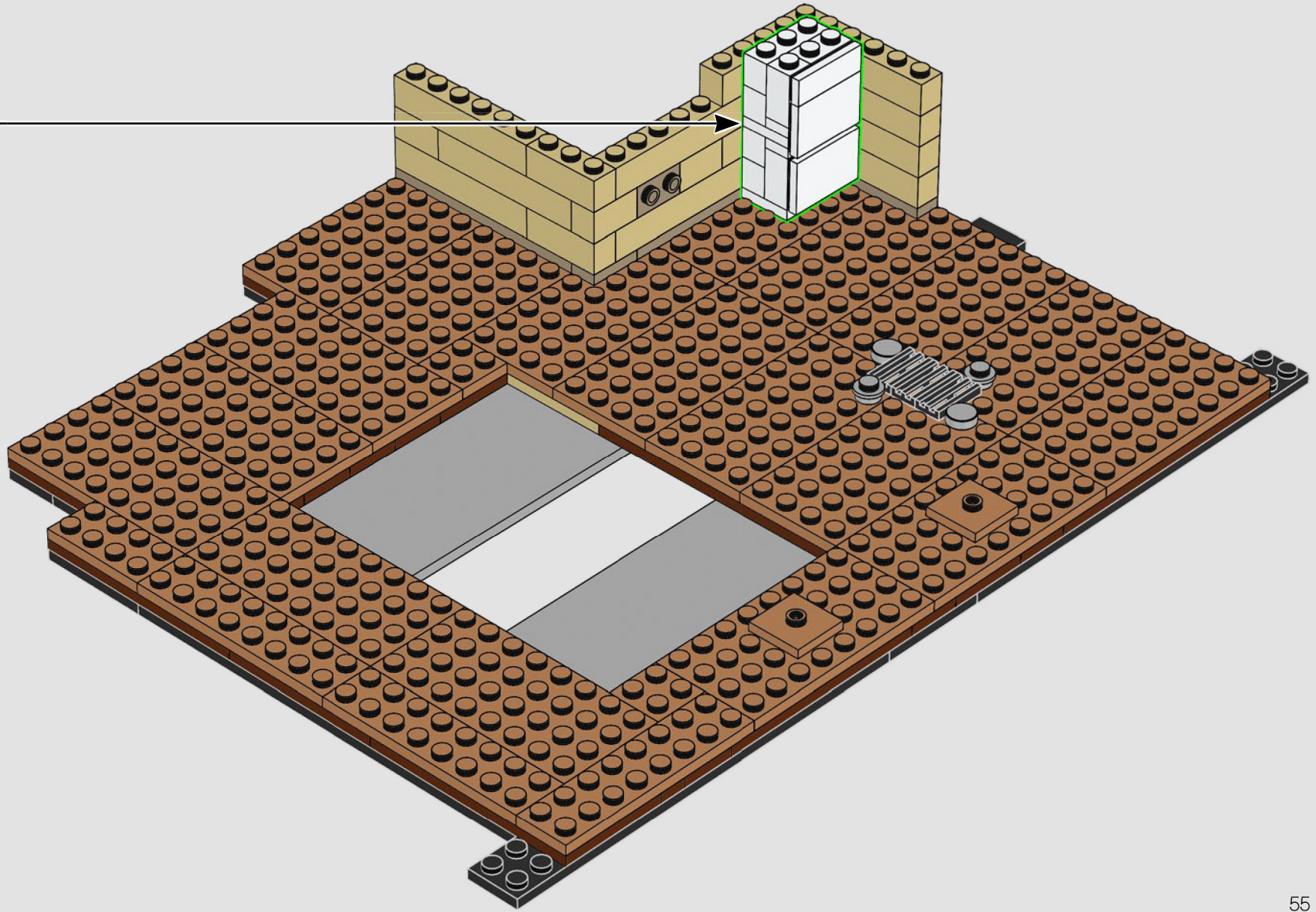

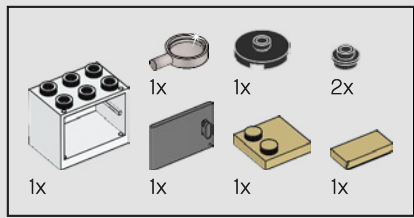

26

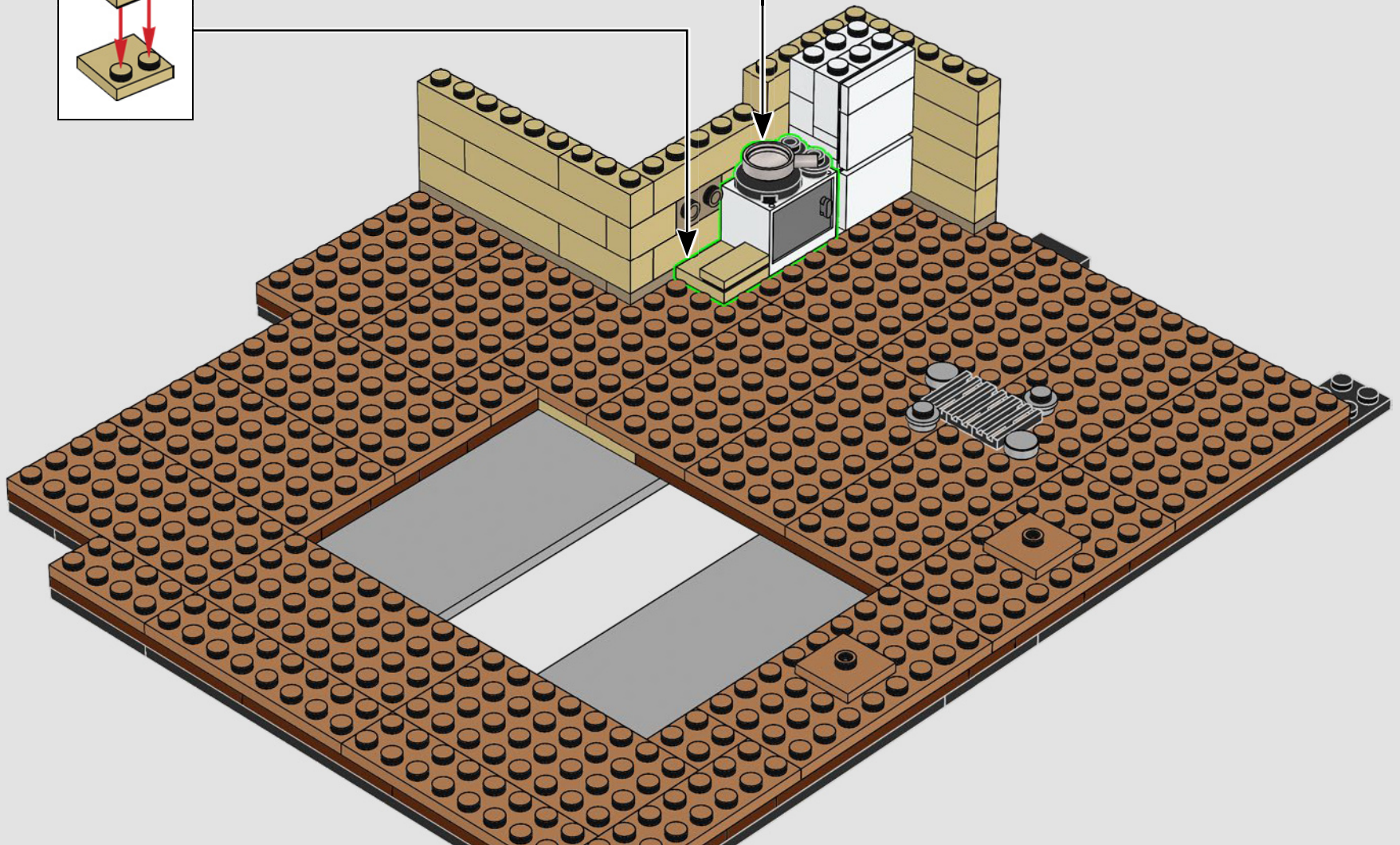
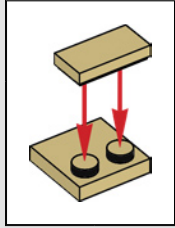
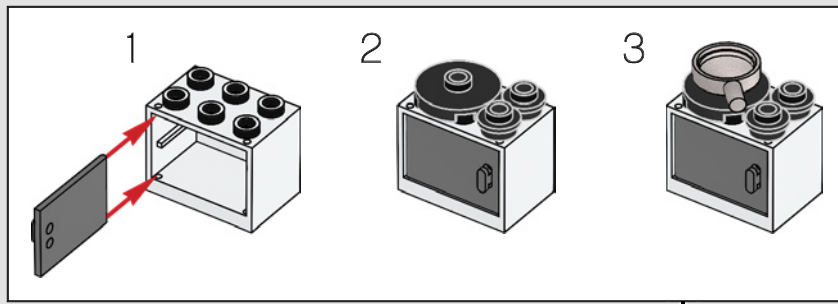



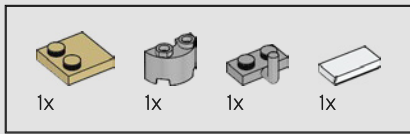

27

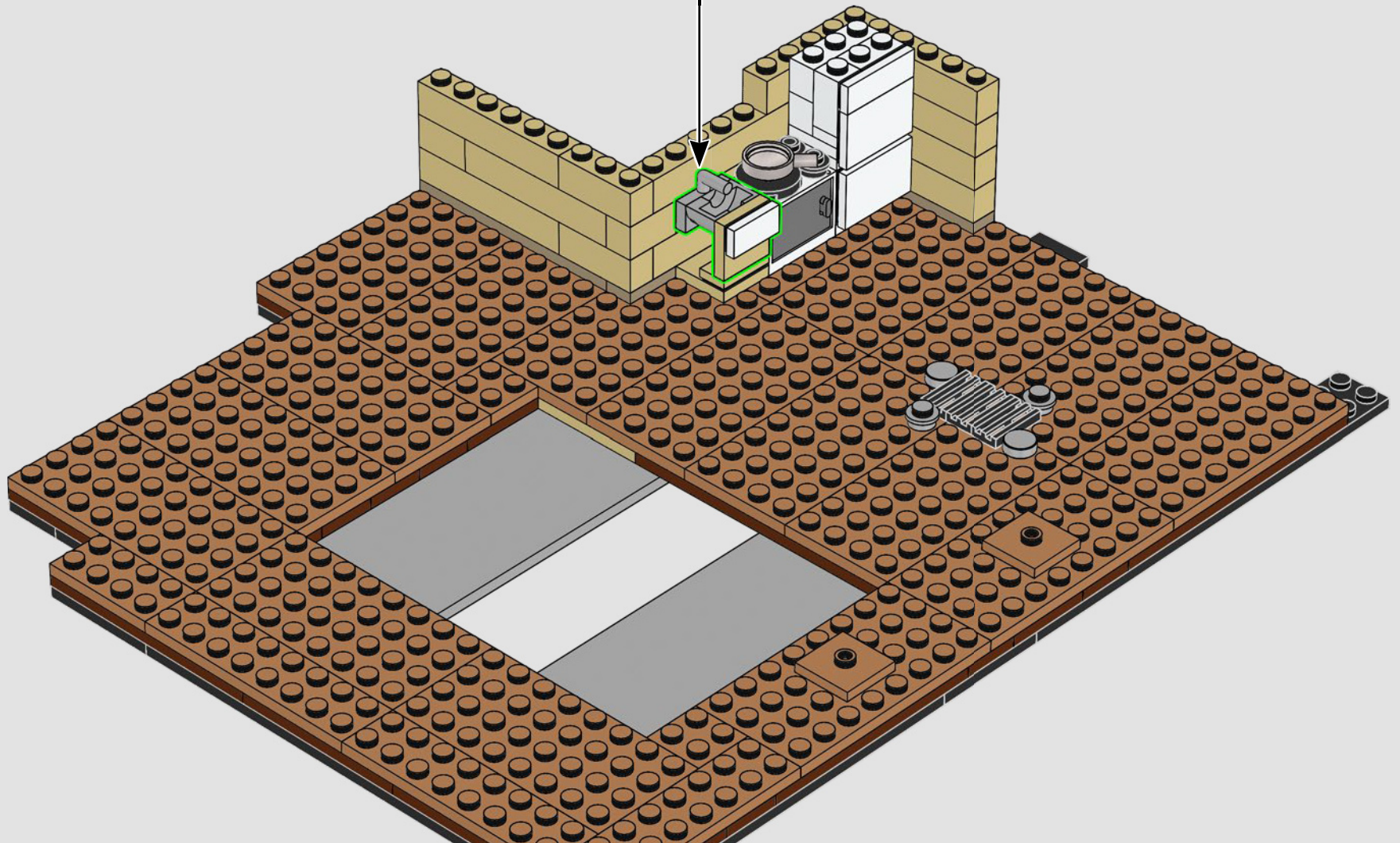
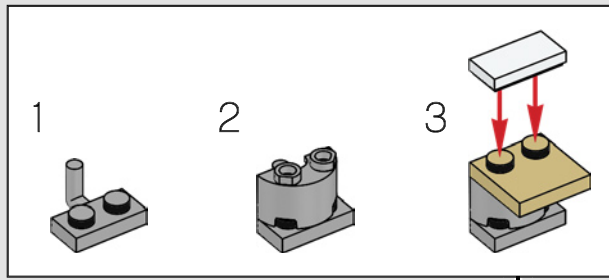

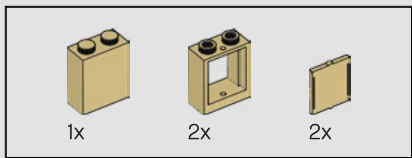

28

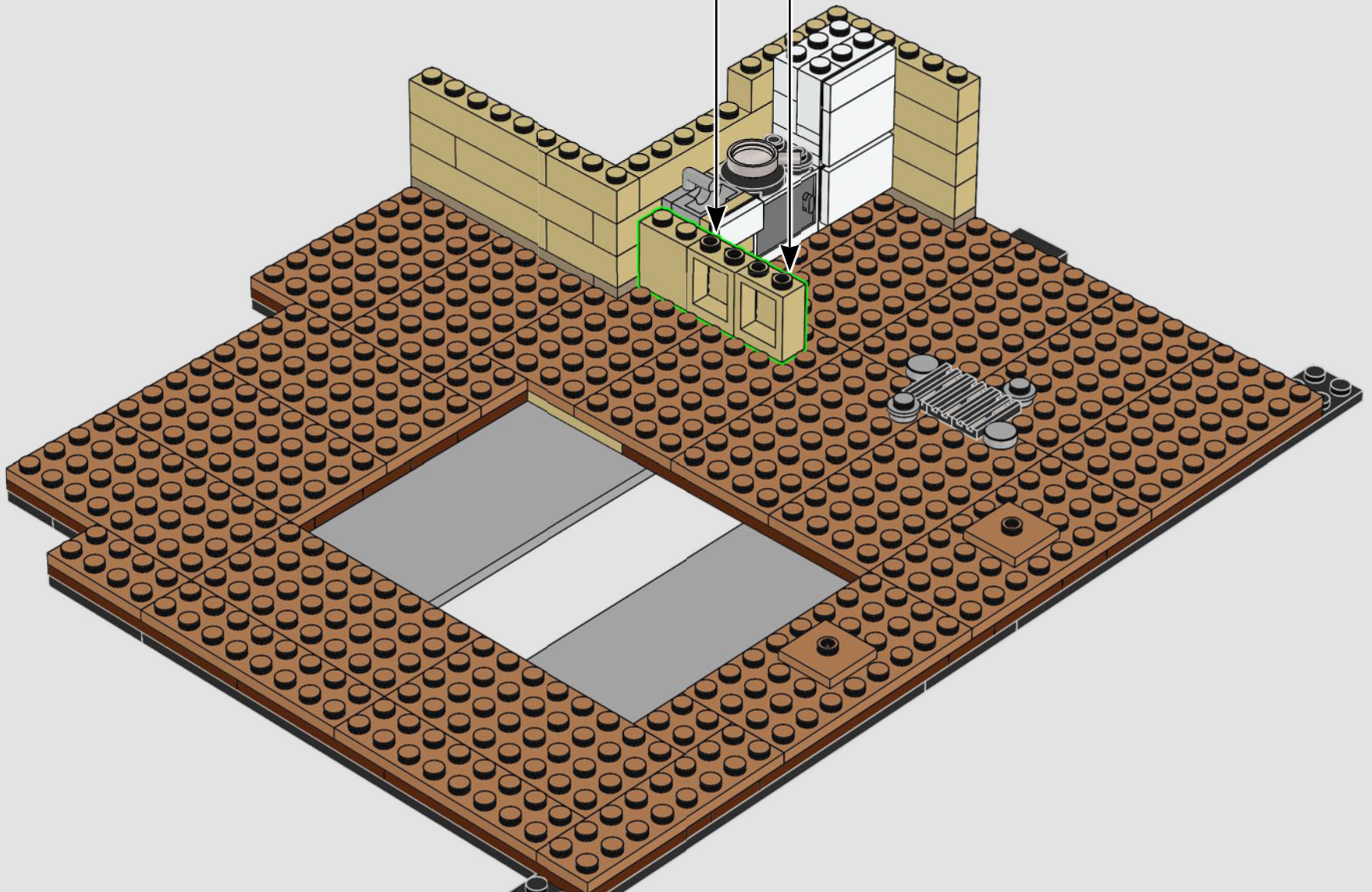
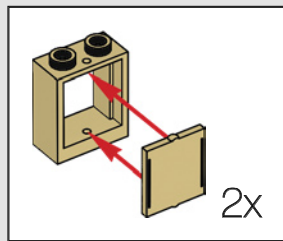



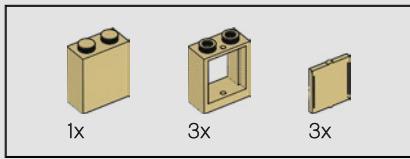

29

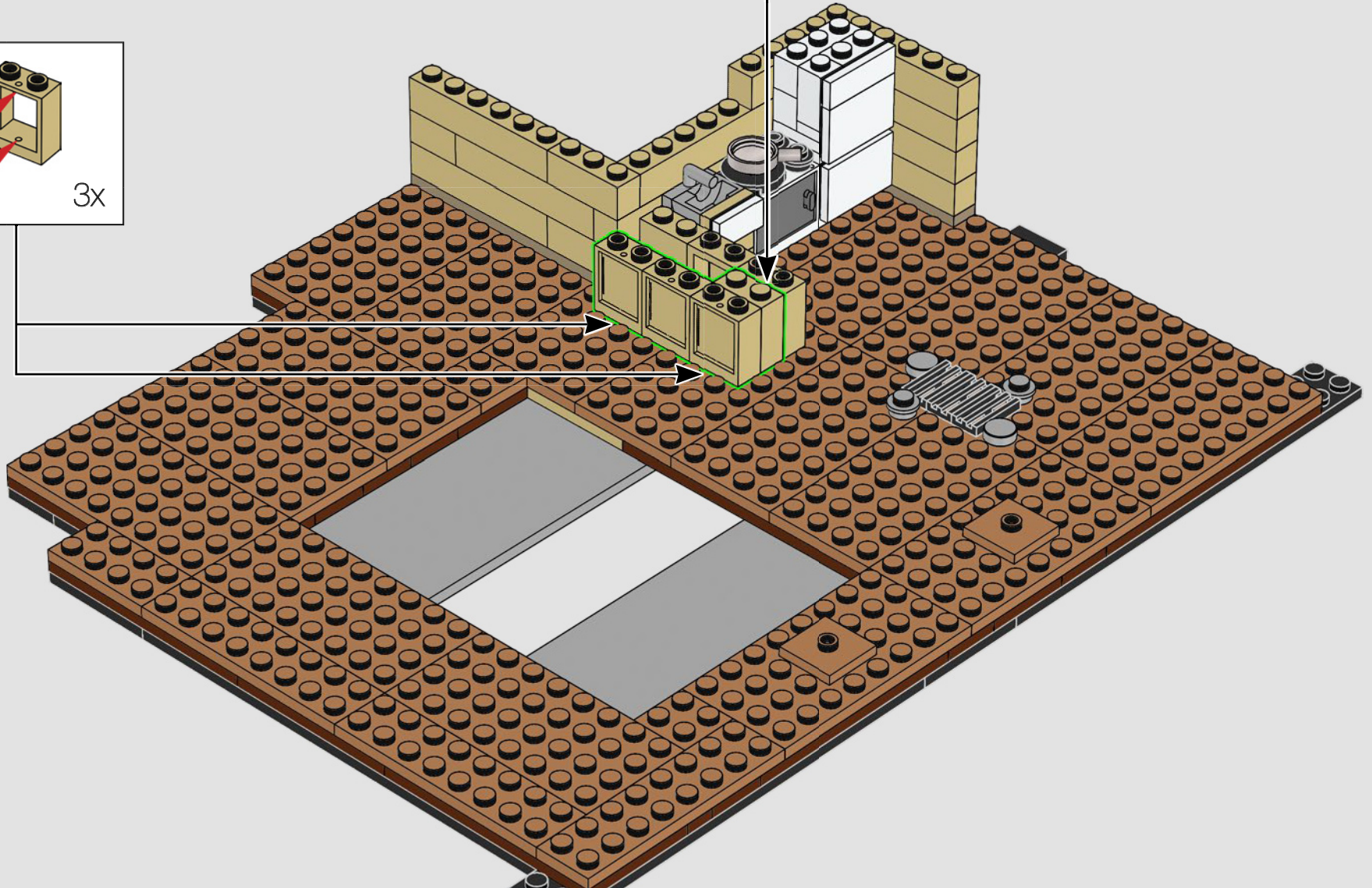
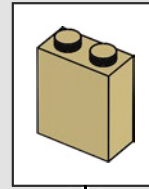
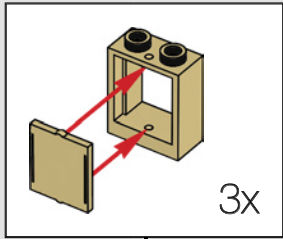



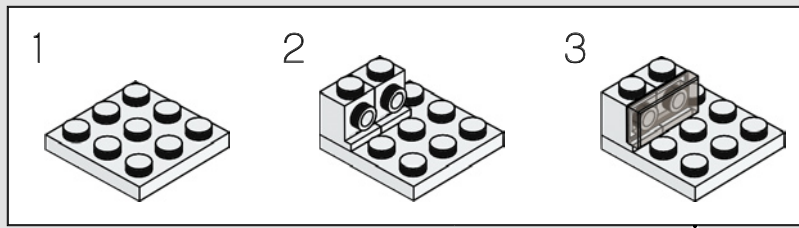
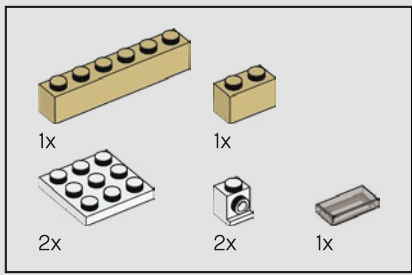

30

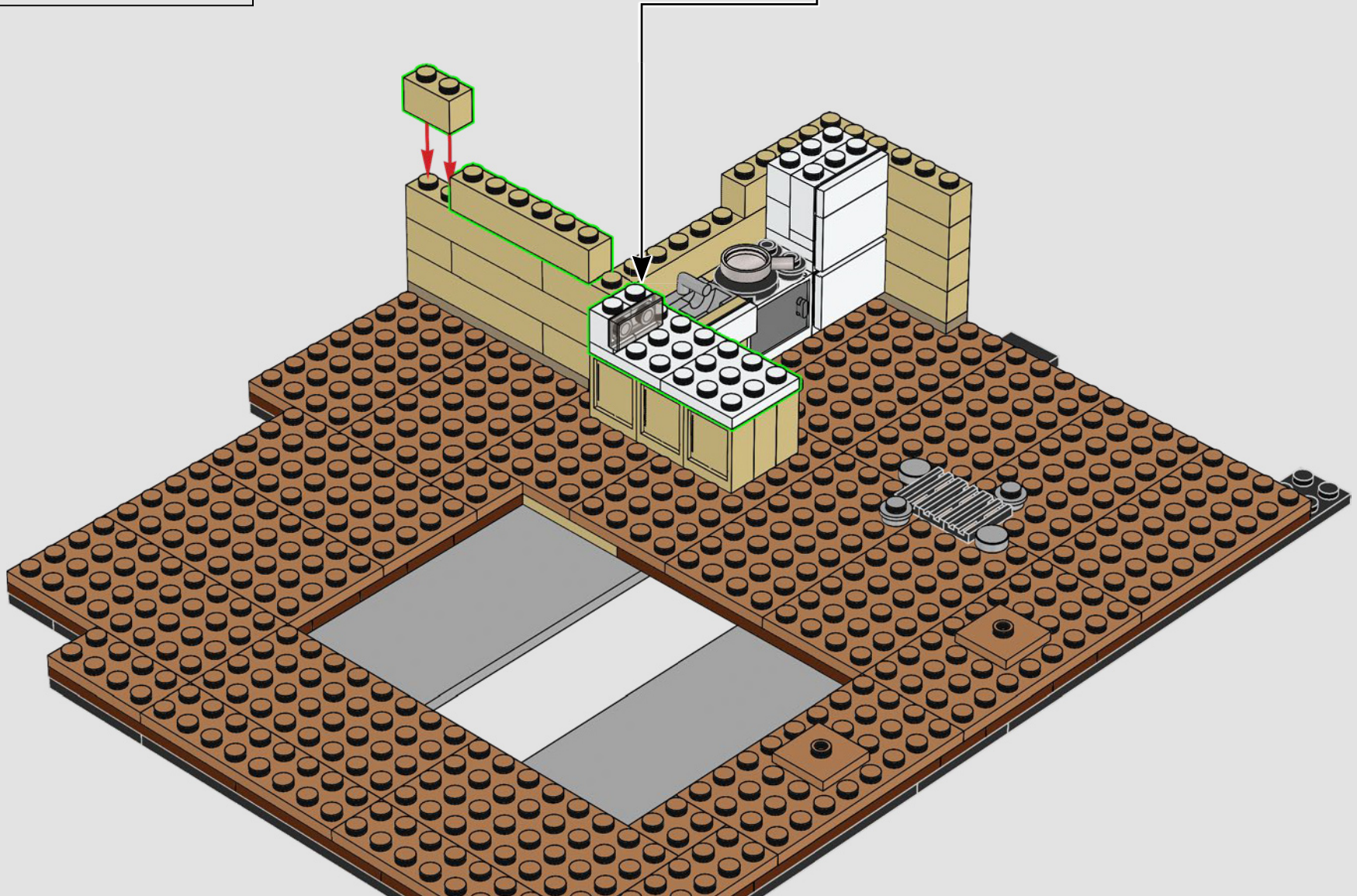



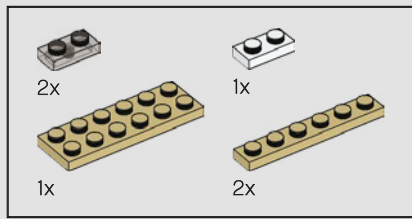

31

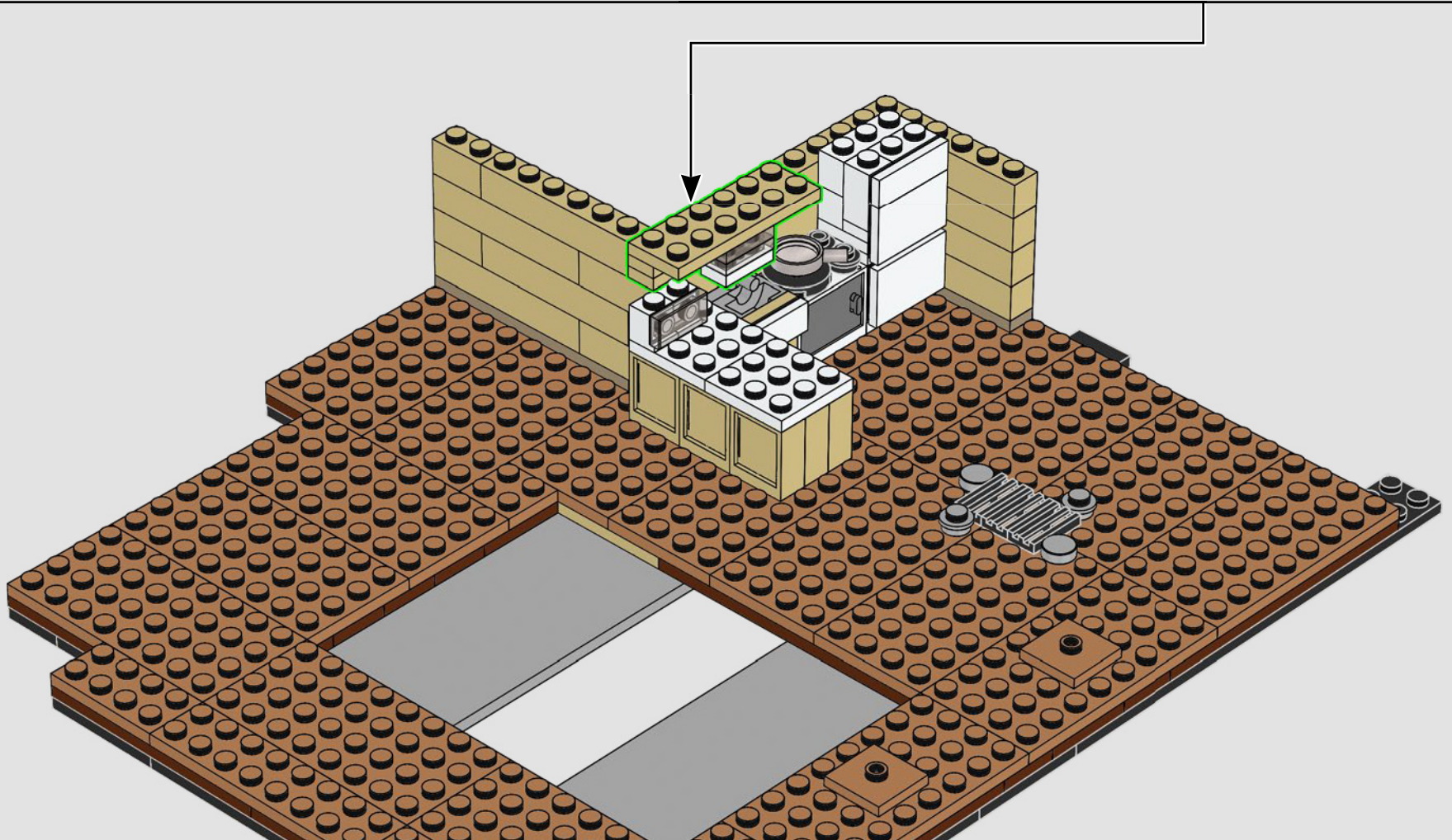
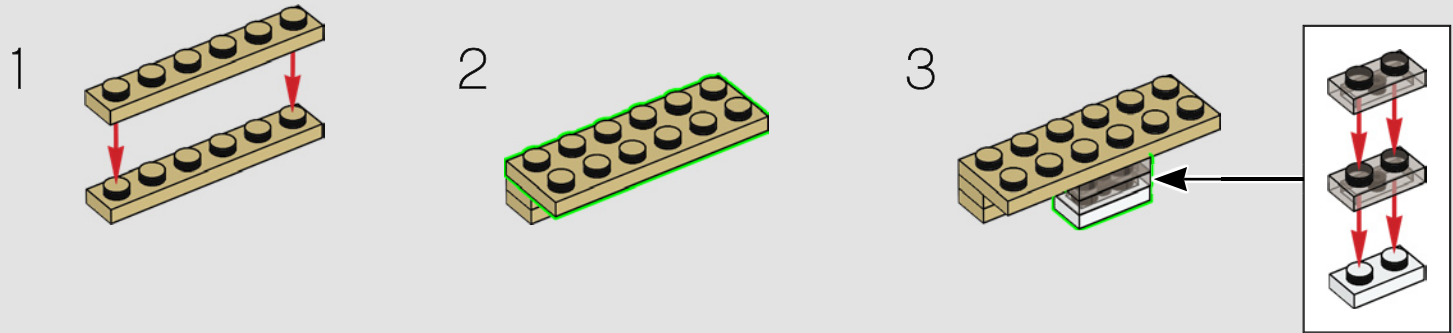



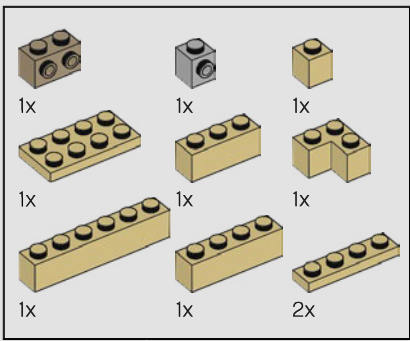

32

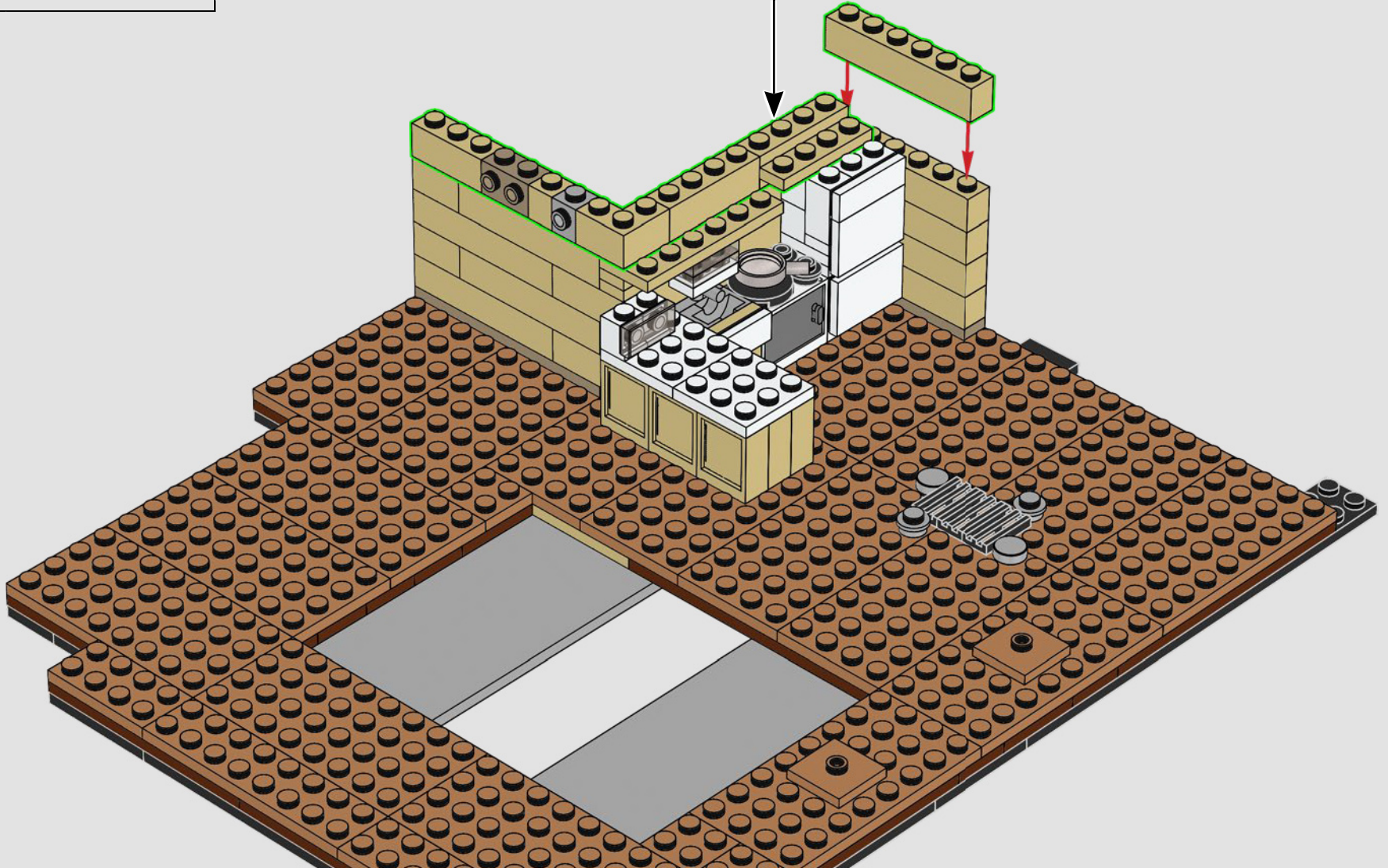
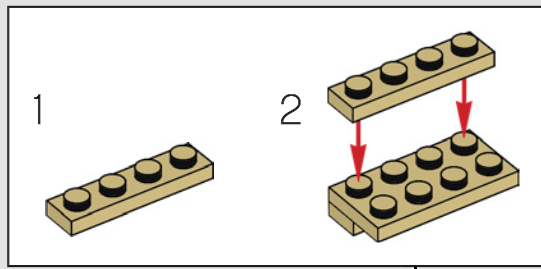





33

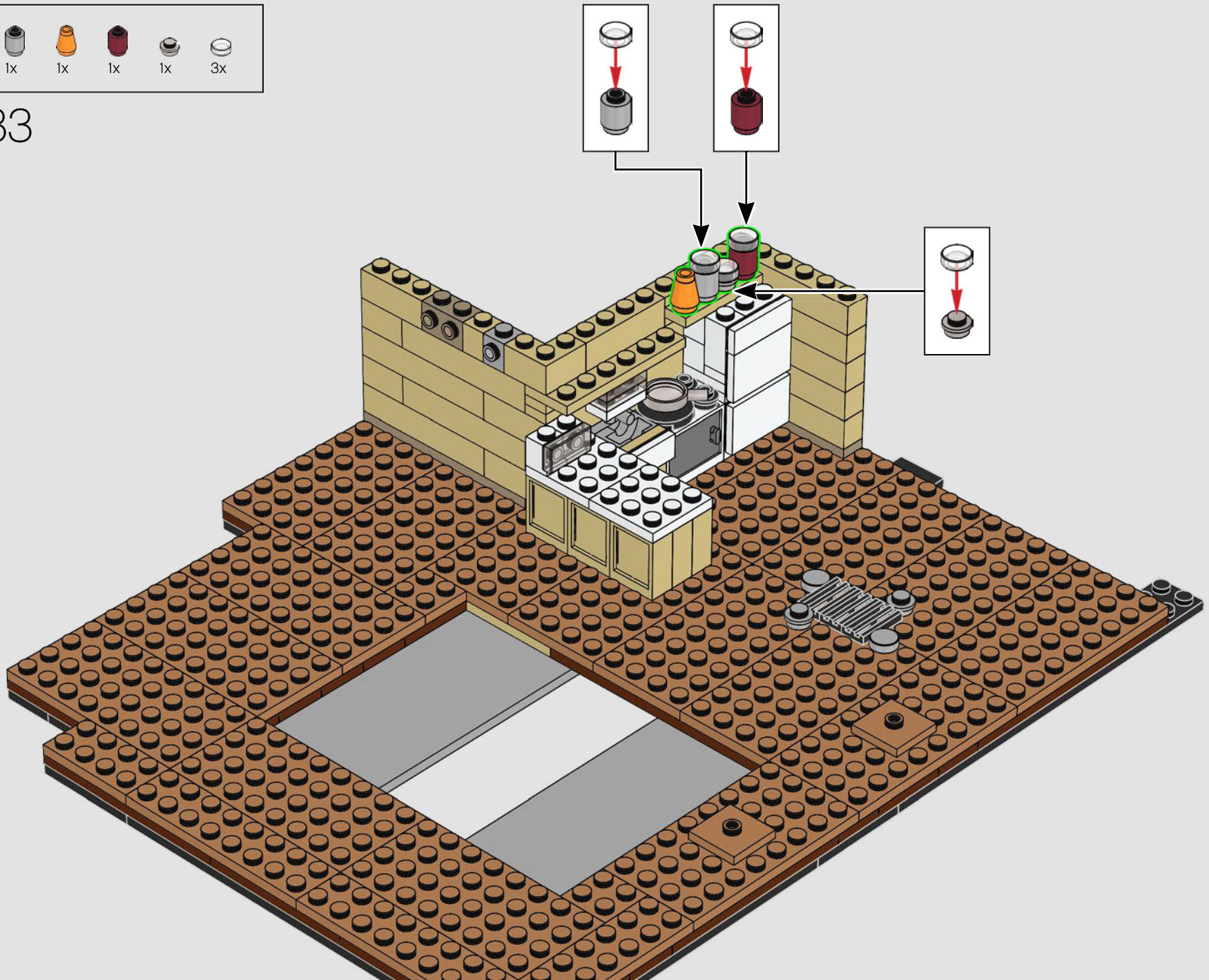



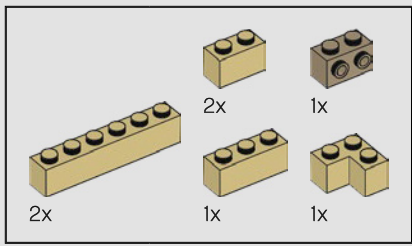

34

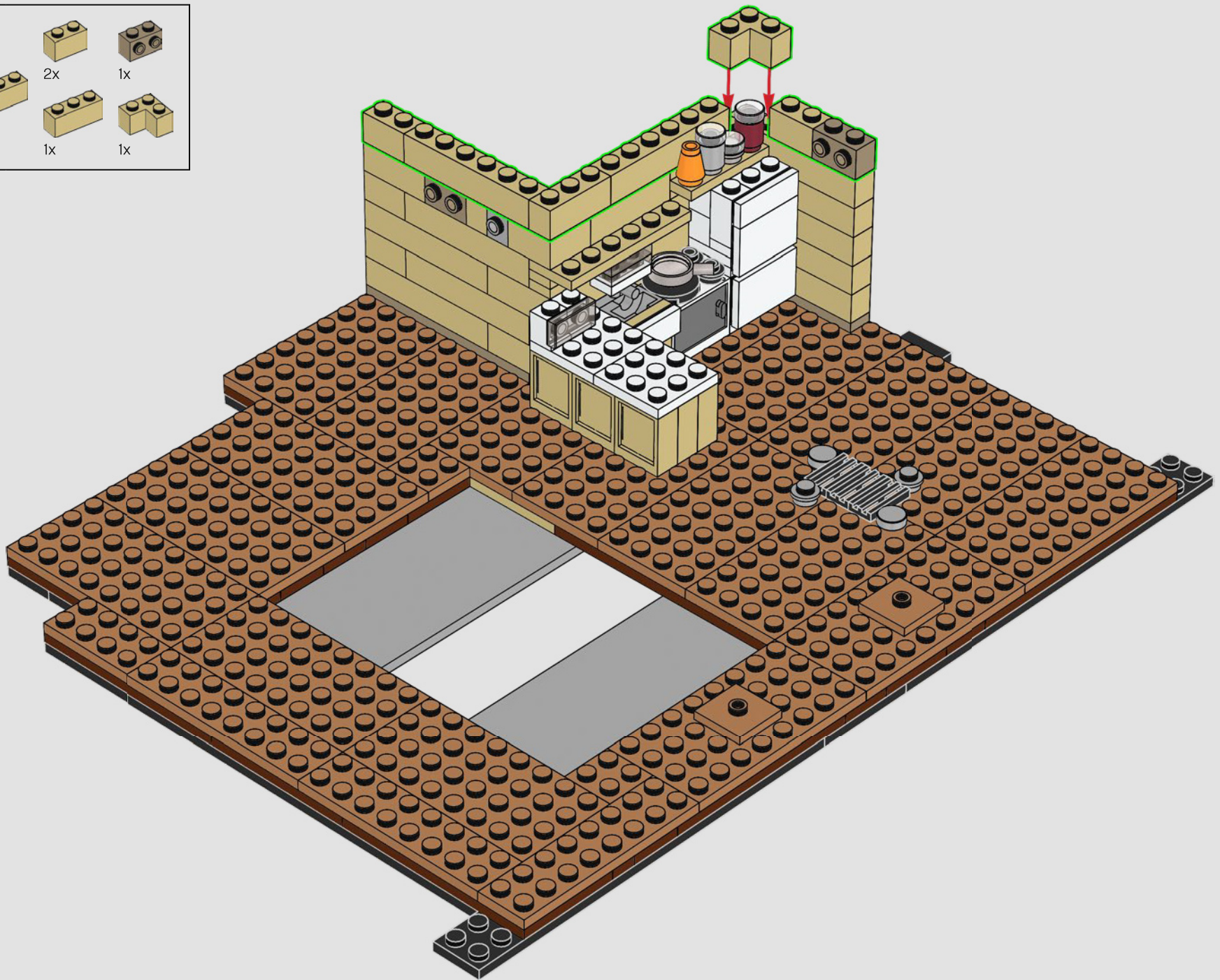



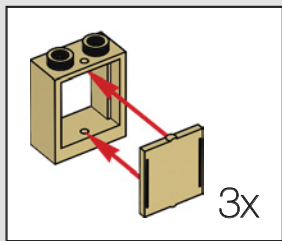
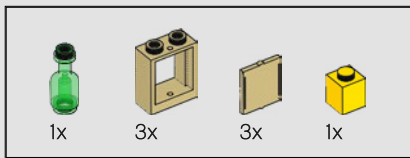

35

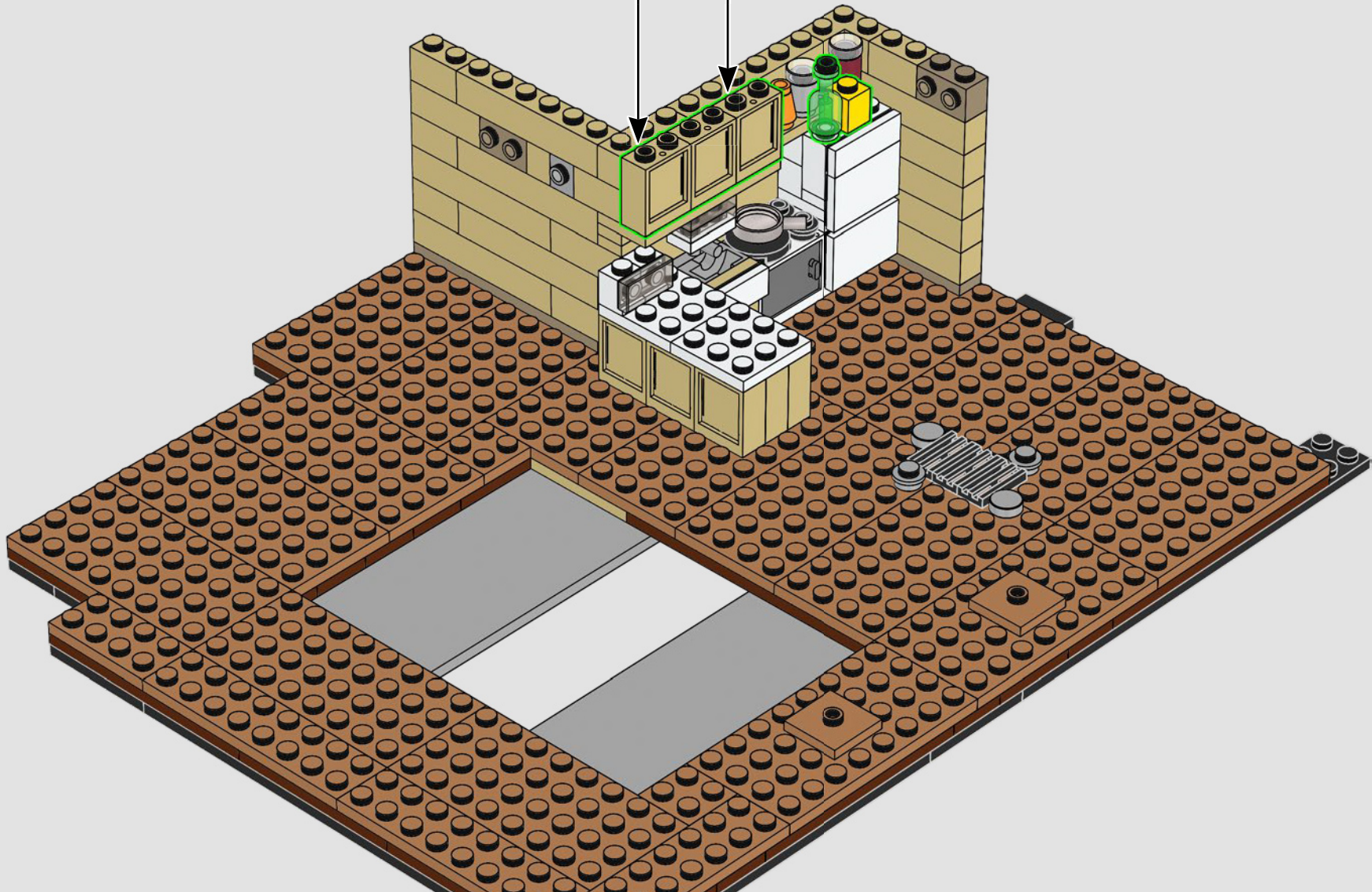



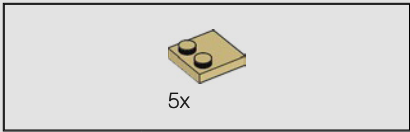

36

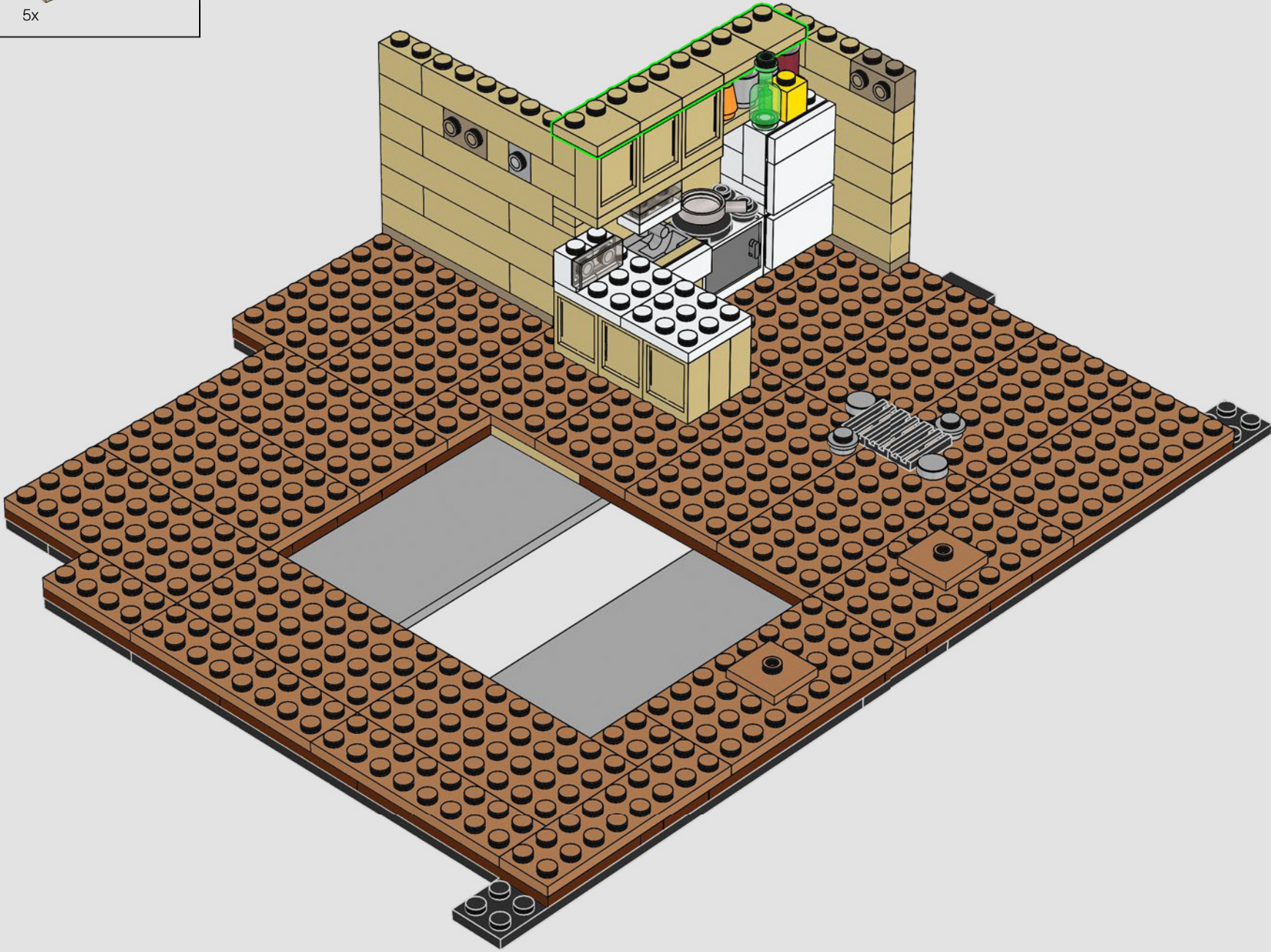



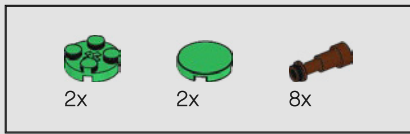

37

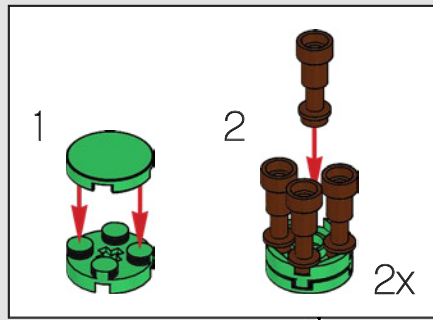



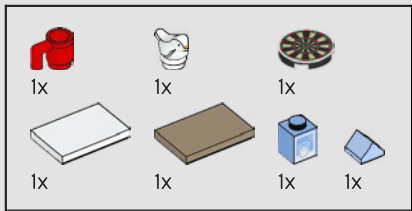

38

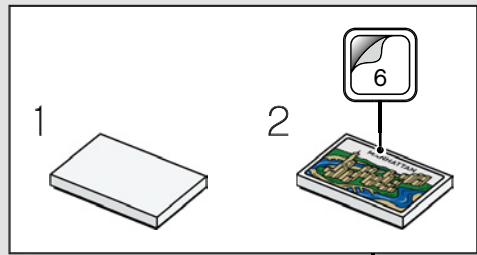
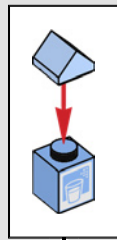
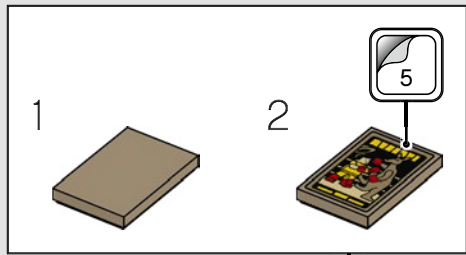

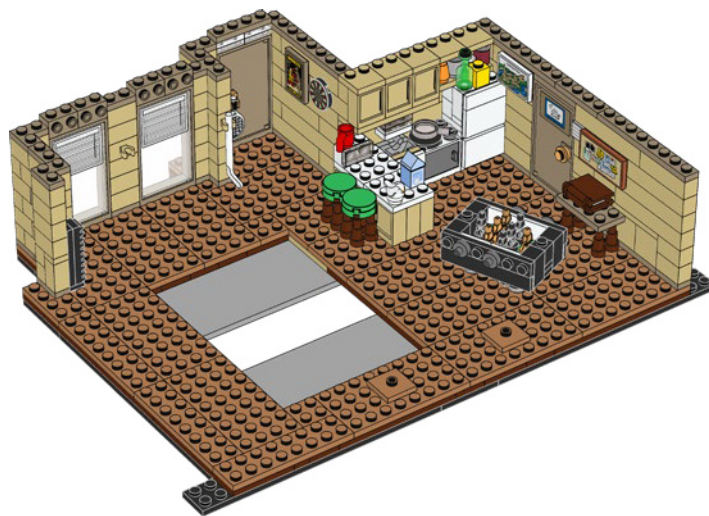



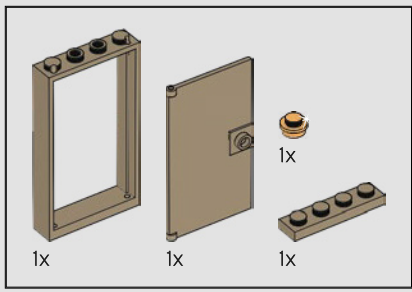

39

1

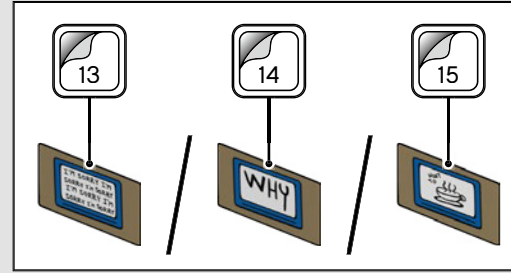
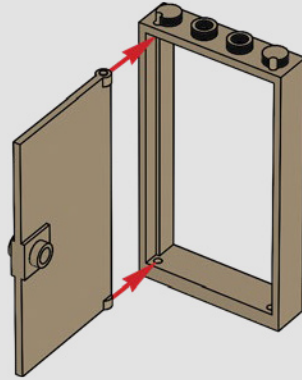

2

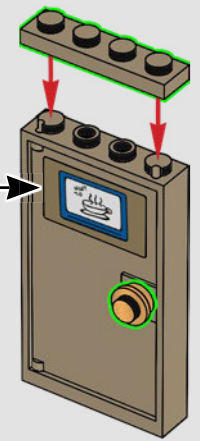

• Elige entre 3 opciones de calcomanías para la pequeña pizarra que se encuentra detrás de la puerta de entrada.





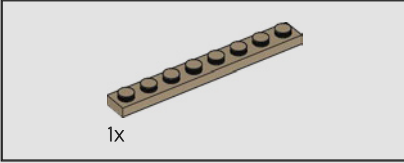
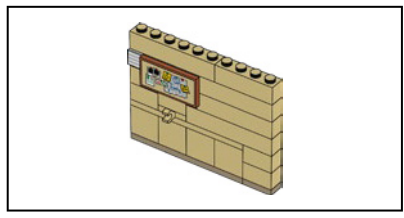

40

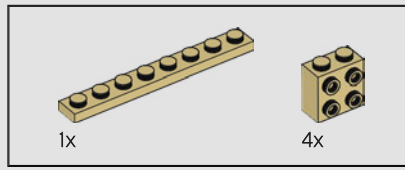
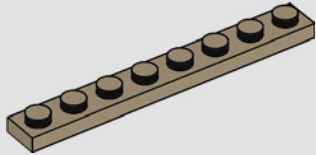

41

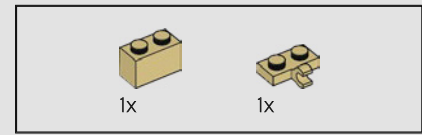
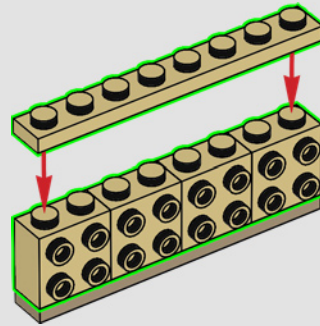

42

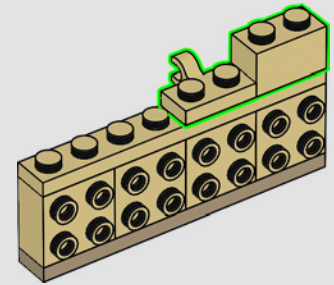

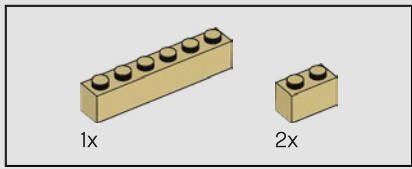

43

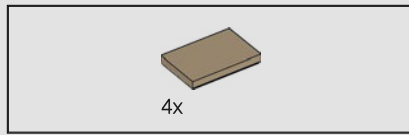
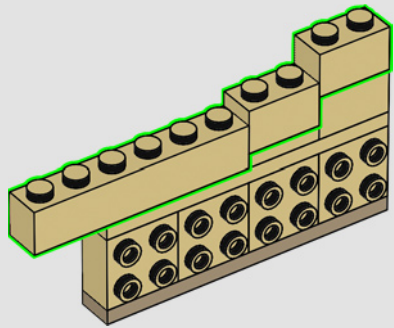

44

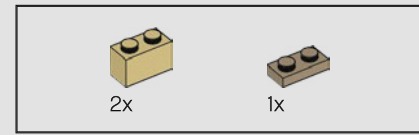
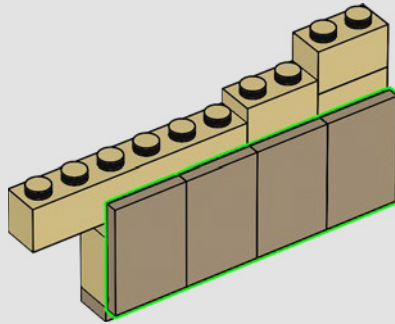

45

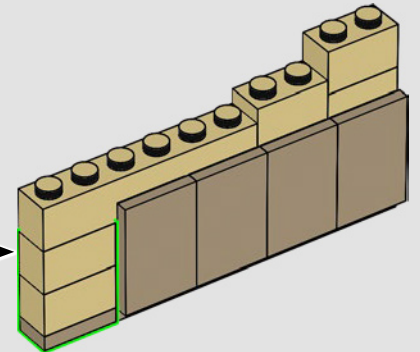
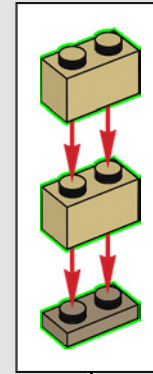

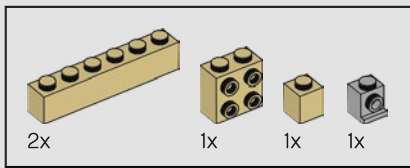

46

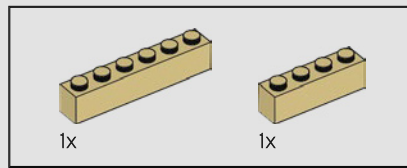
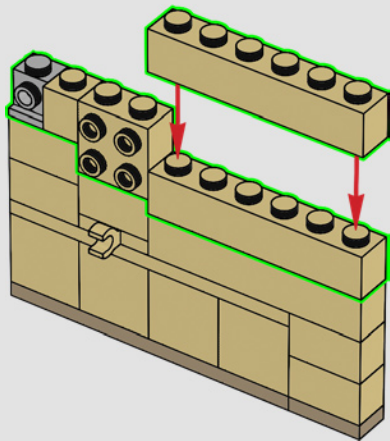

47

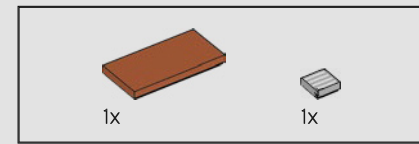
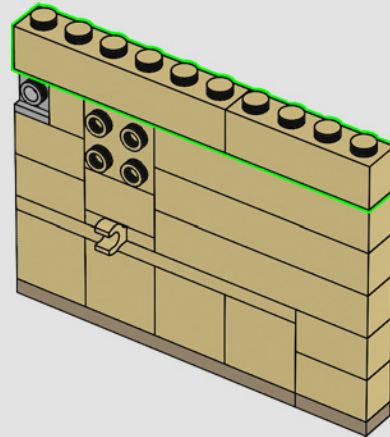

48

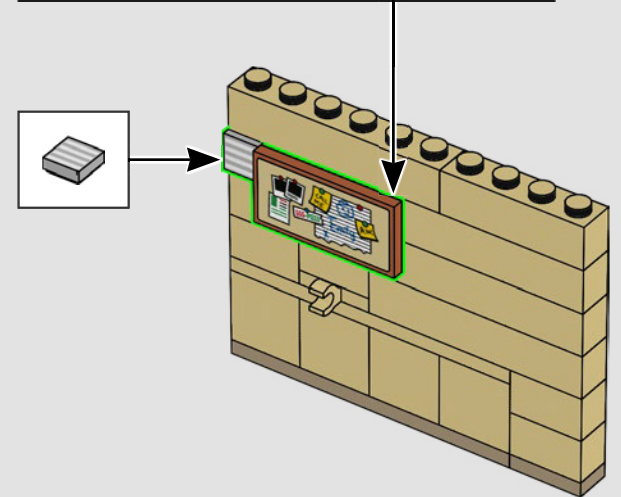
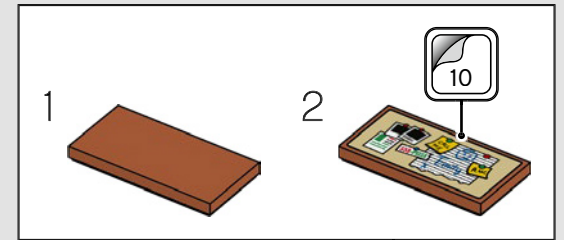



49





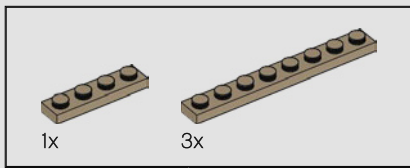

50





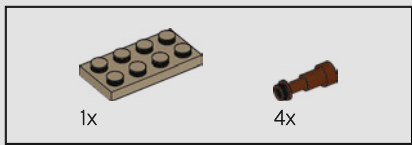

51

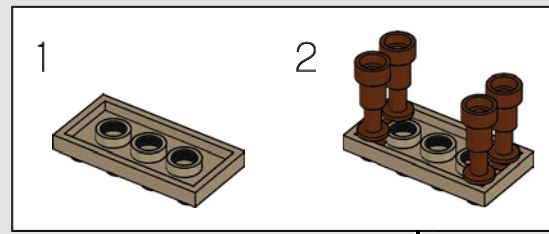



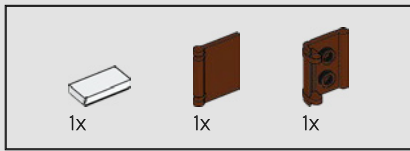

52

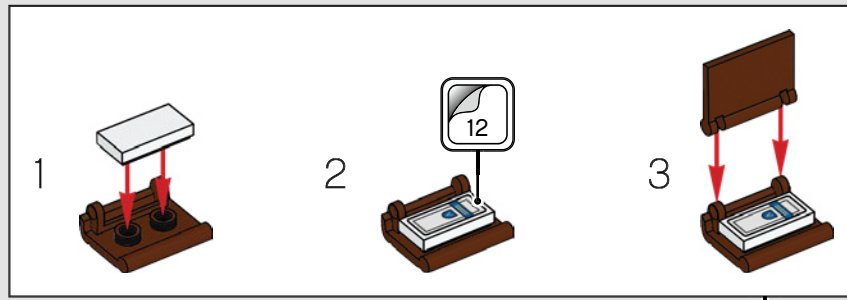

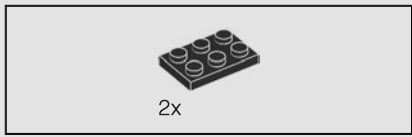

53

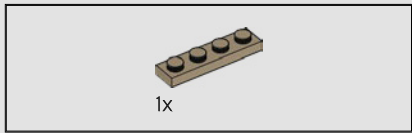
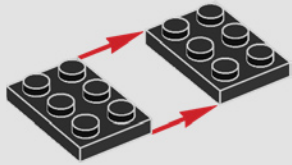

54

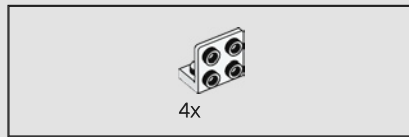
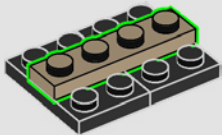

55

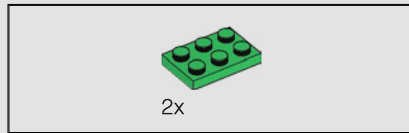
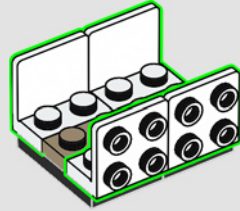

56

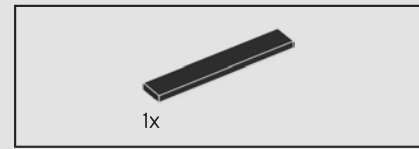
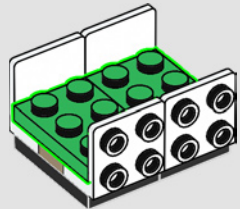

57

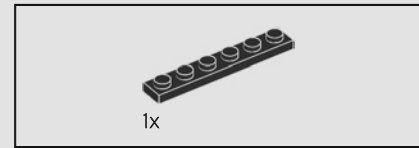
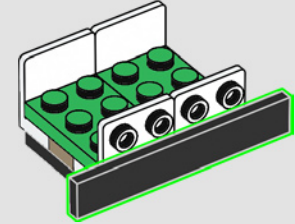

58

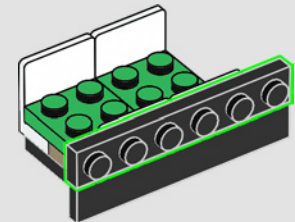

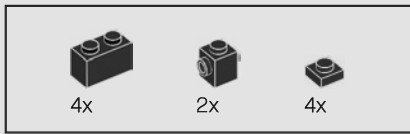

59

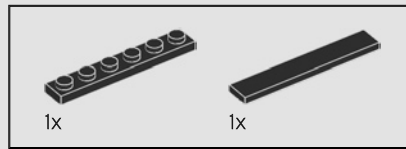
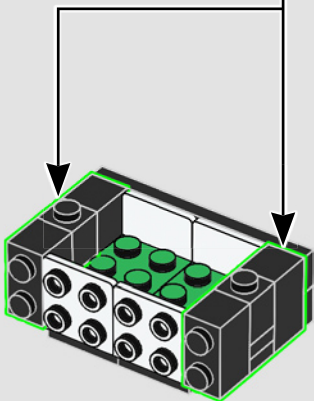
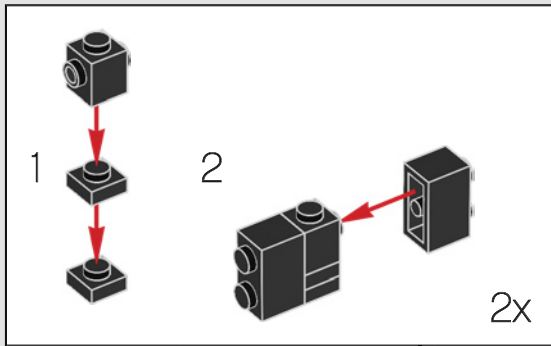

60

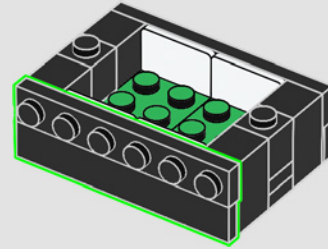

61

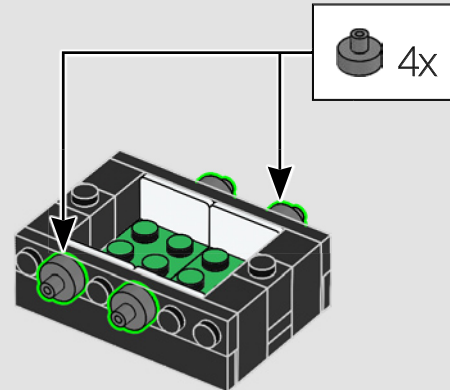

62

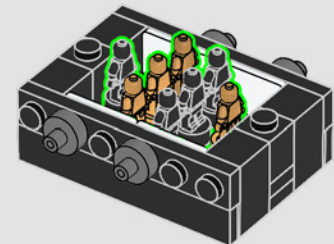



63





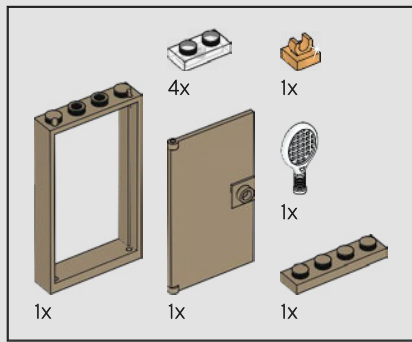

64

1

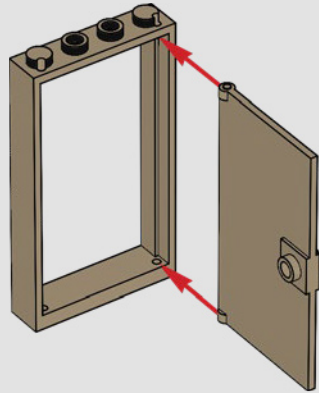

2

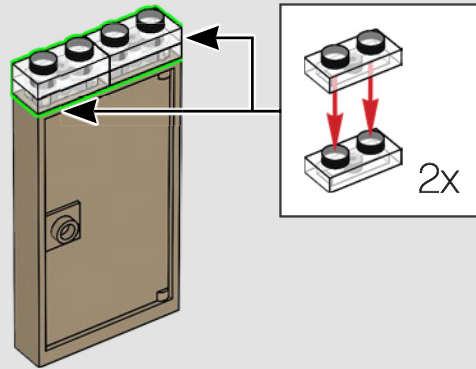

3

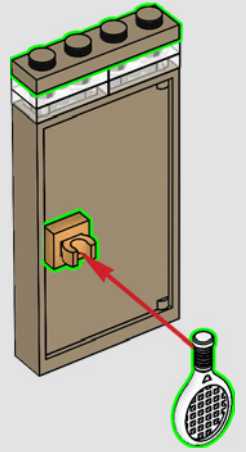

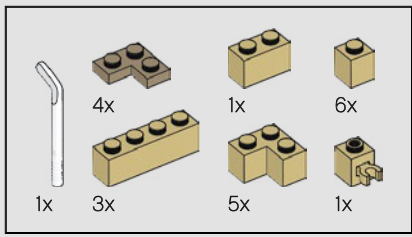

65

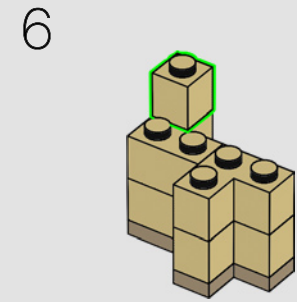
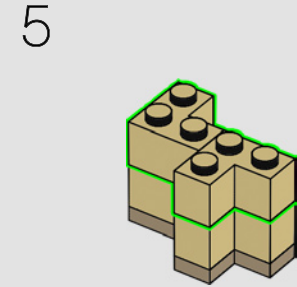
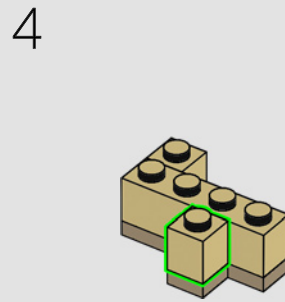
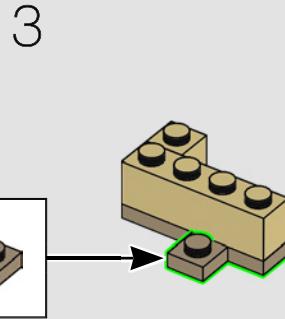
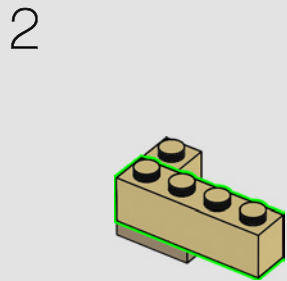
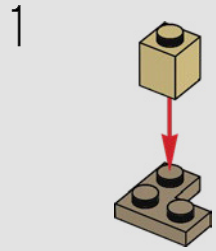



7

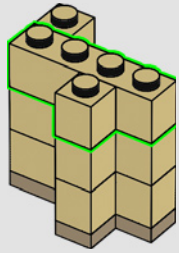

8

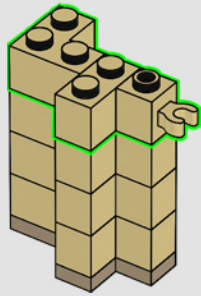

9

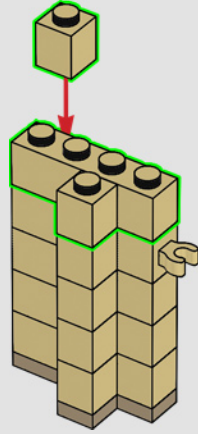

10

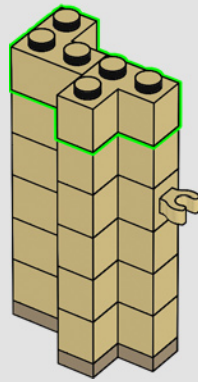

11

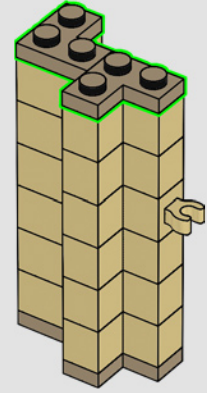

12

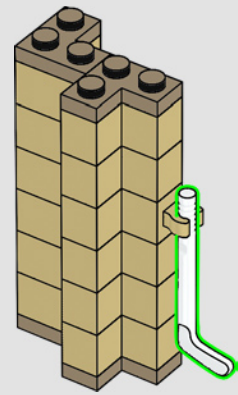





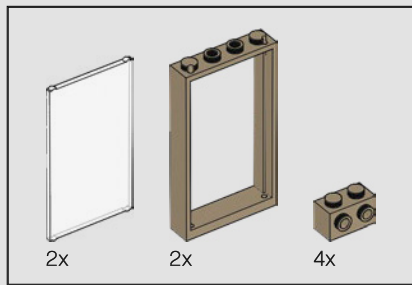

66

1

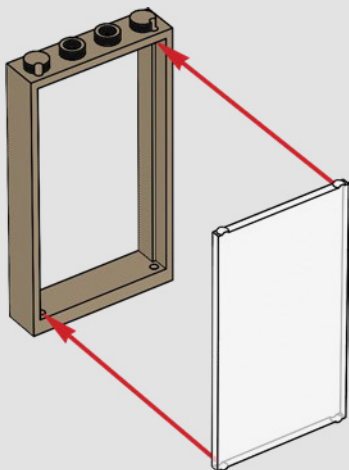

2

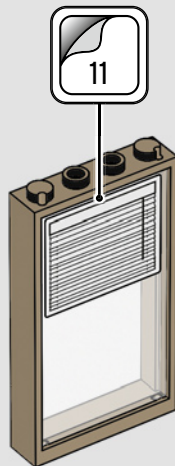

3

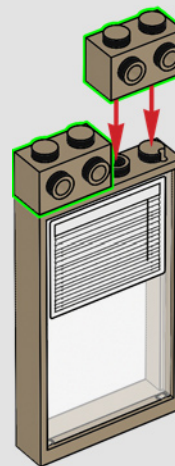

2x

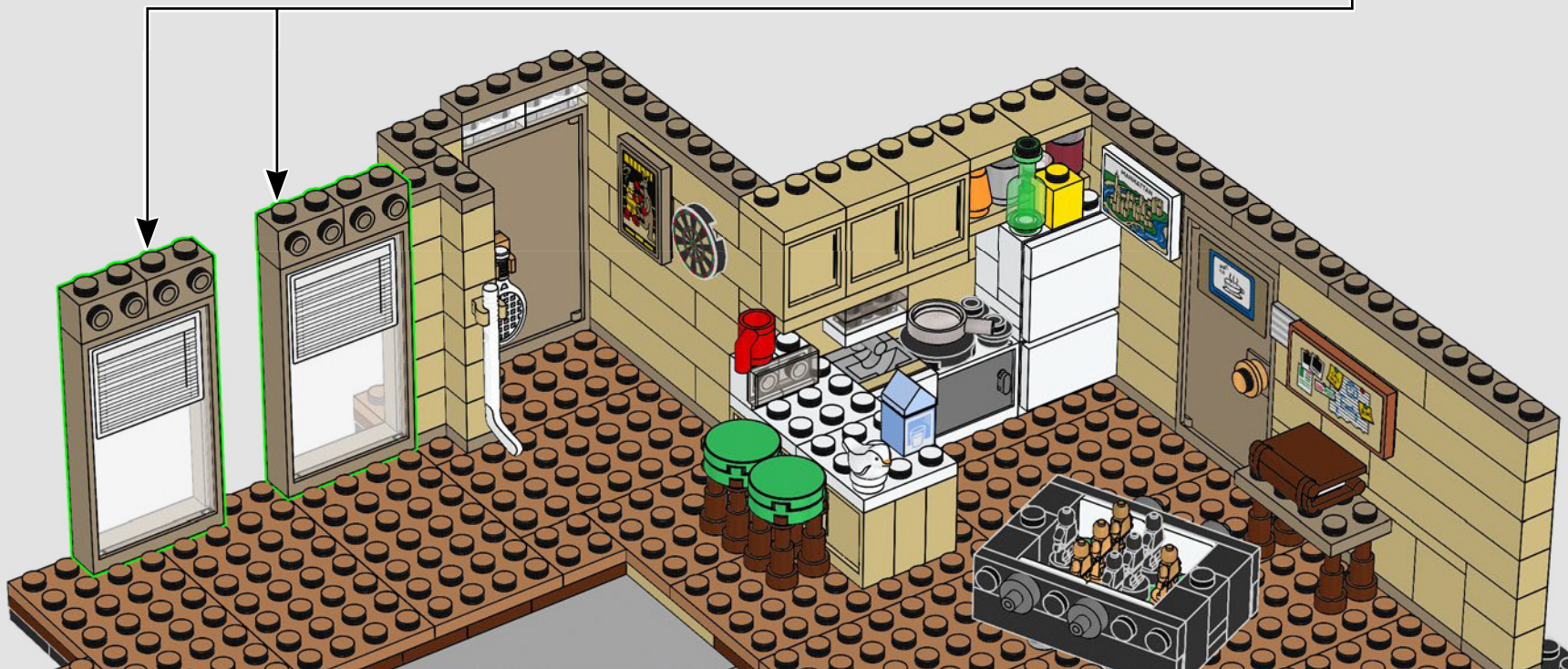



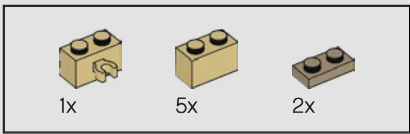

67

1

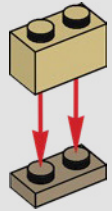

2

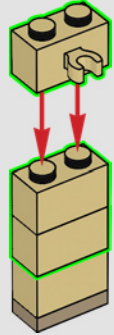

3

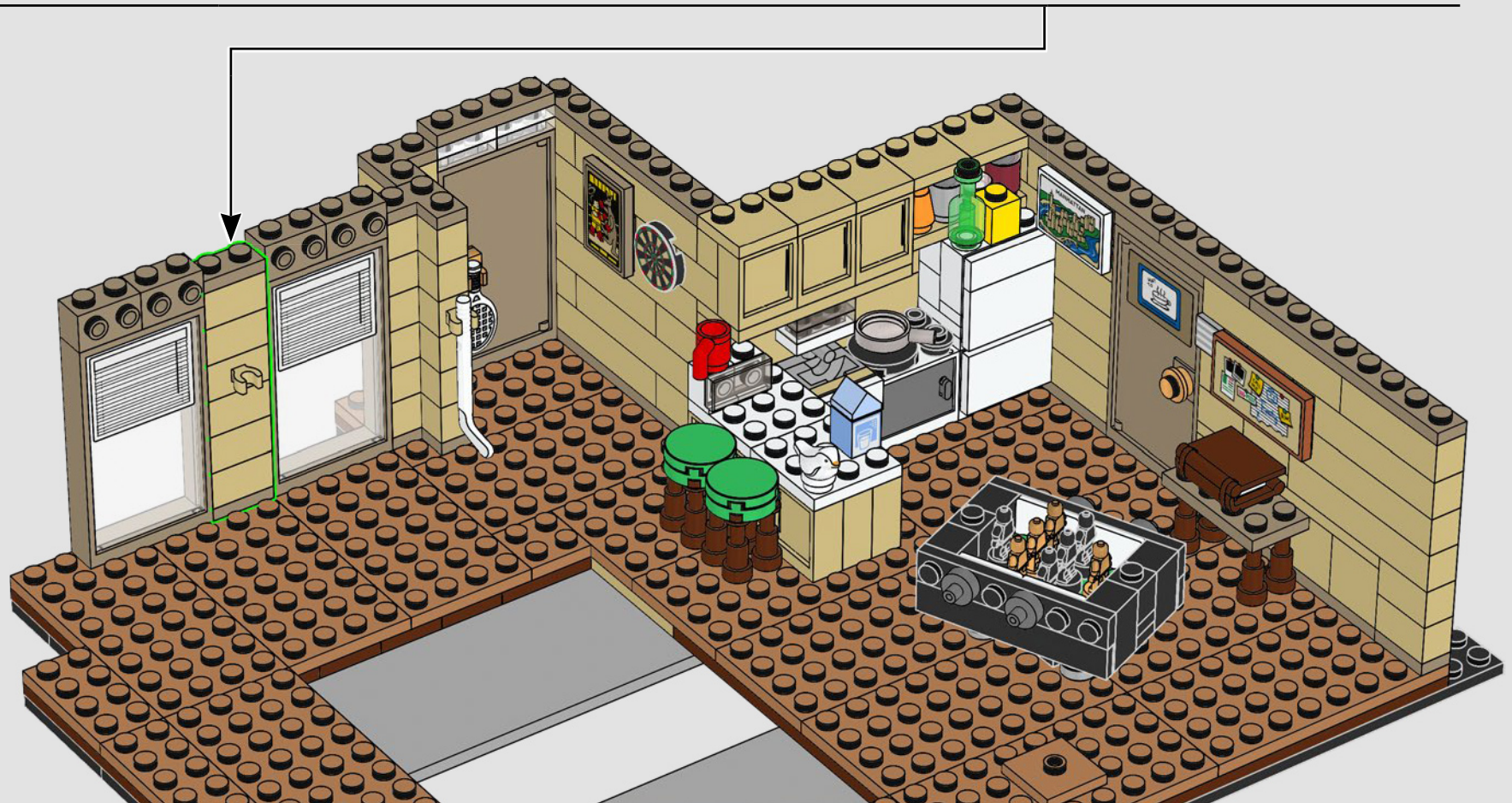
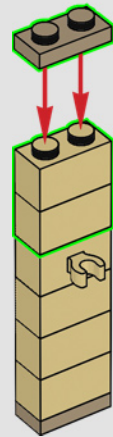



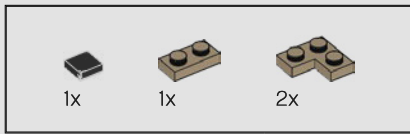

68



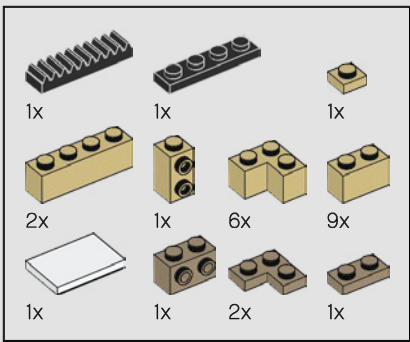

69

1

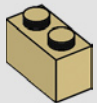

2

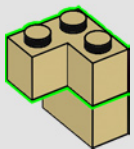

3

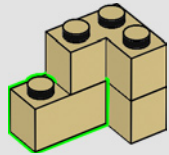

4

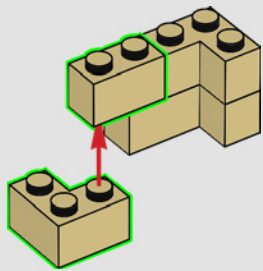

5

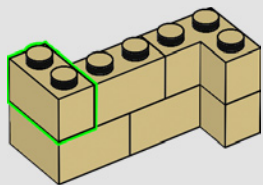

6

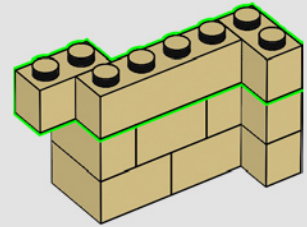

7

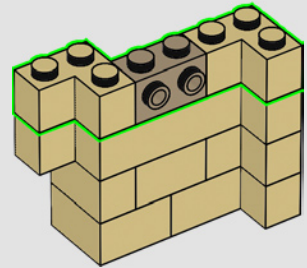

8

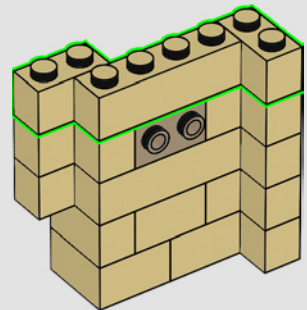



9

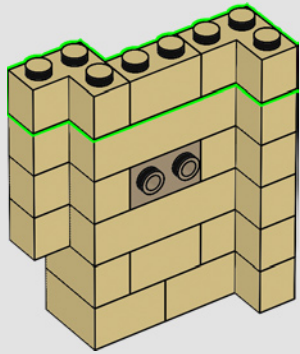

10

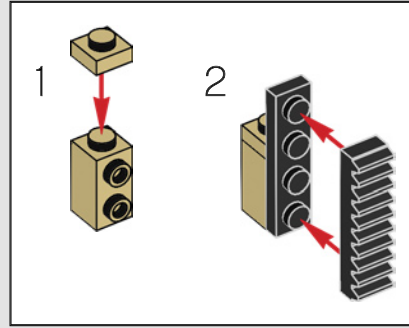
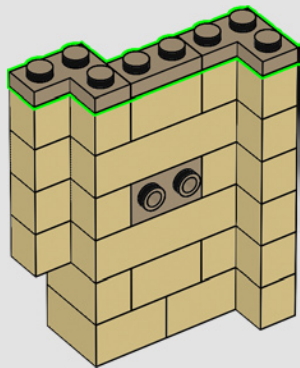

11

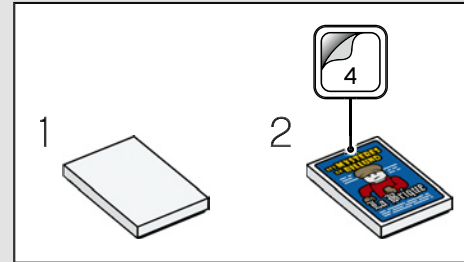
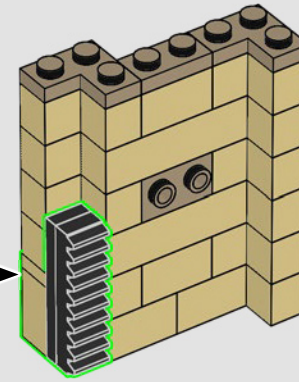

12

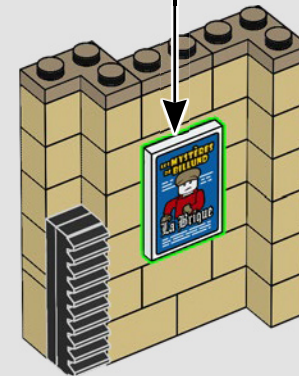

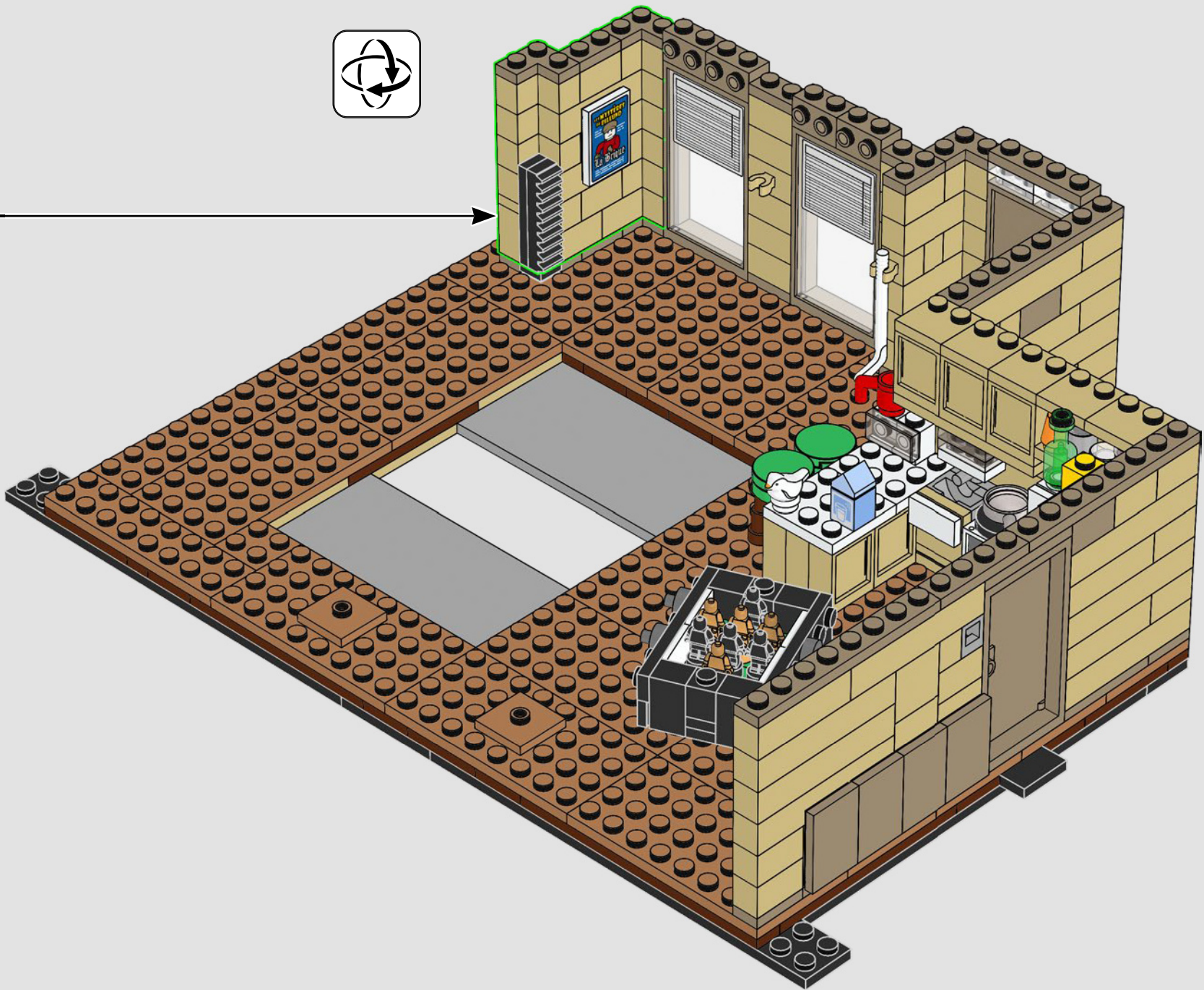

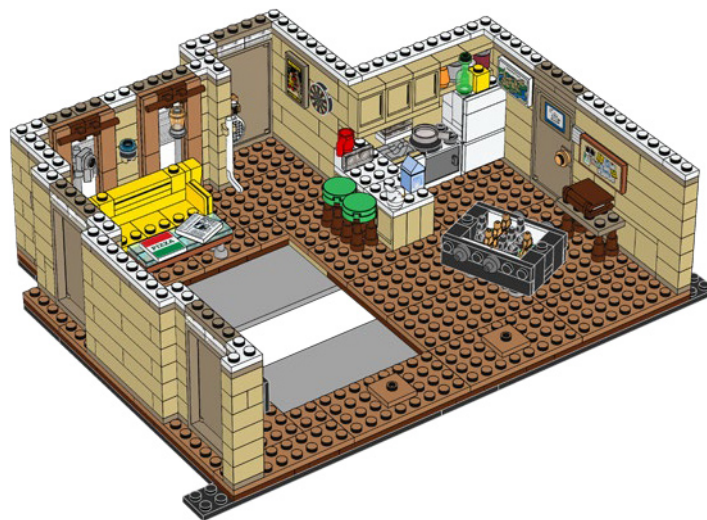



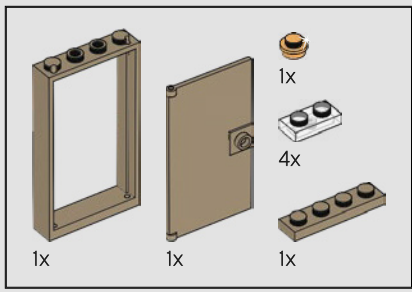

70

1

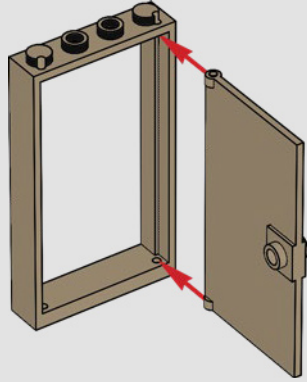

2

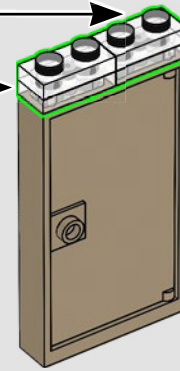
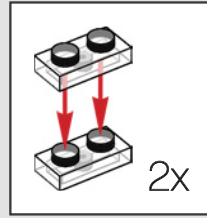

3

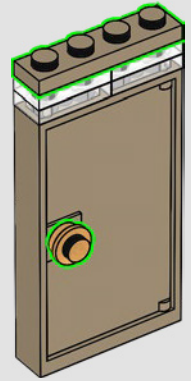

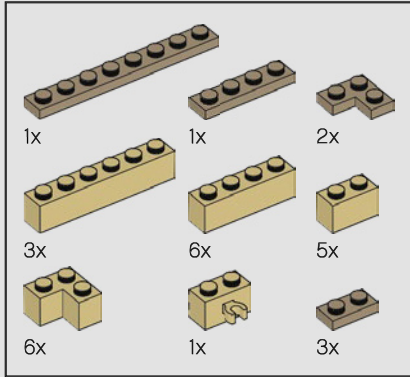
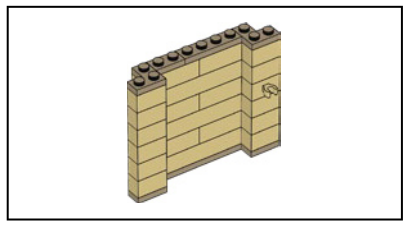

71

1

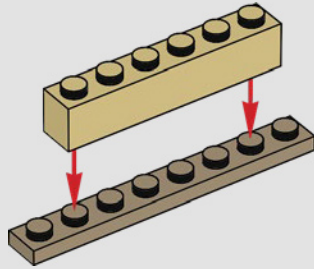

2

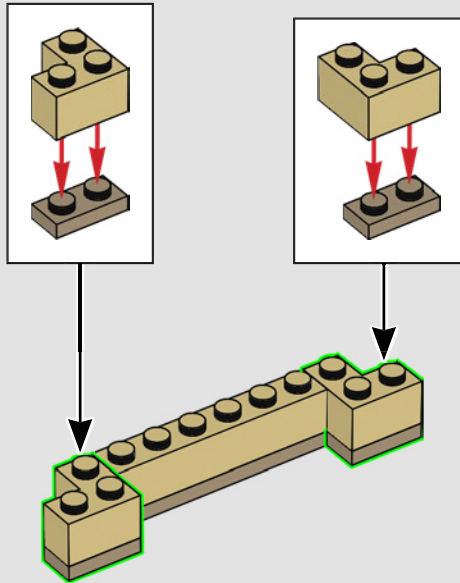

3

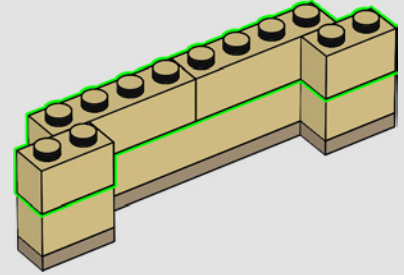

4

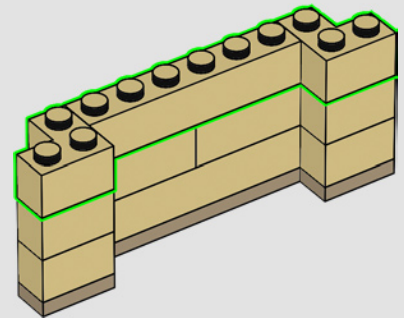

5

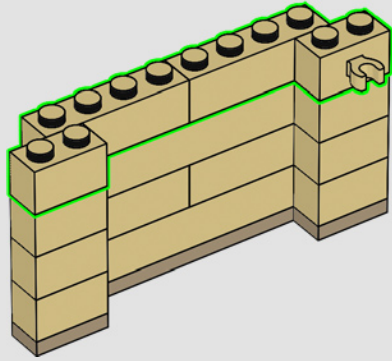

7

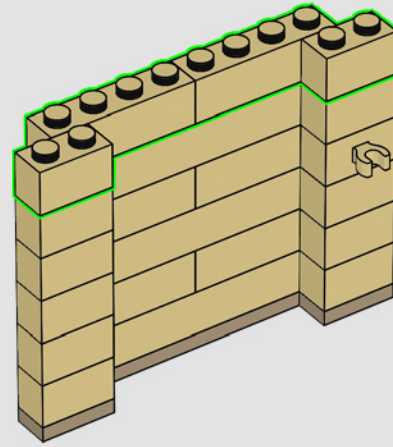

6

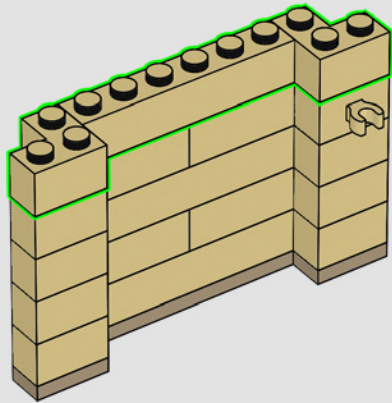

8

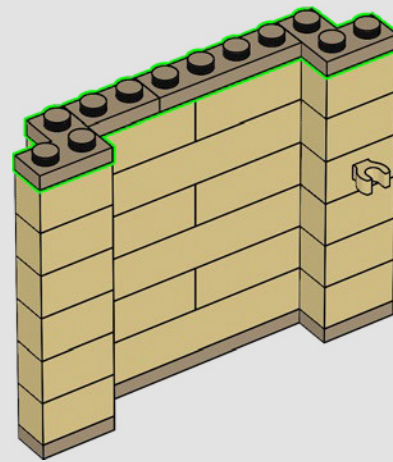



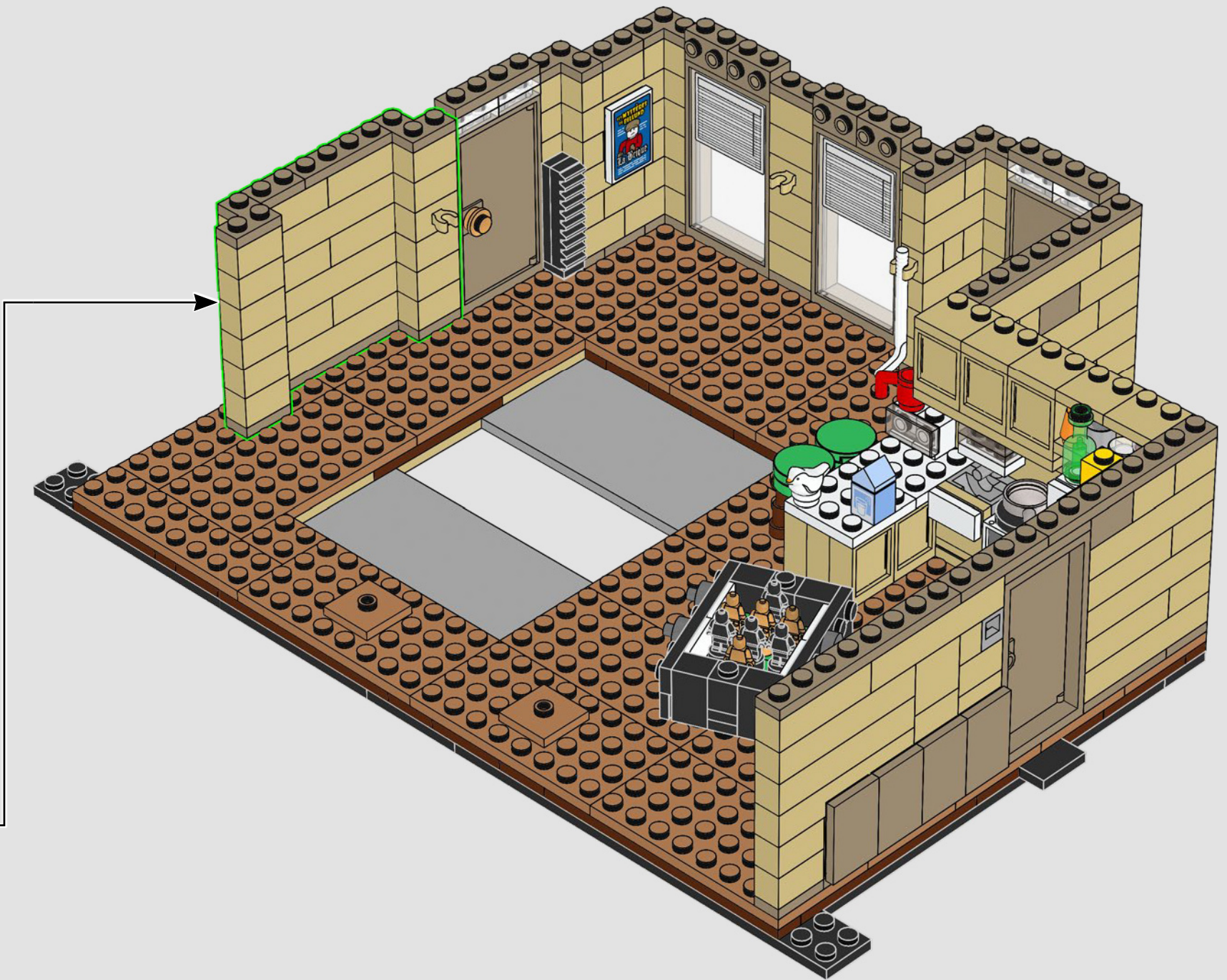



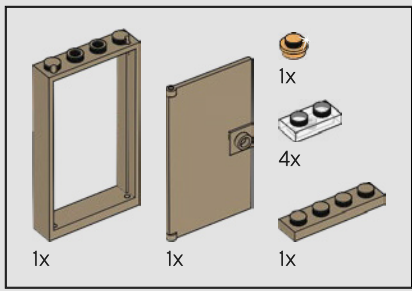

72

1

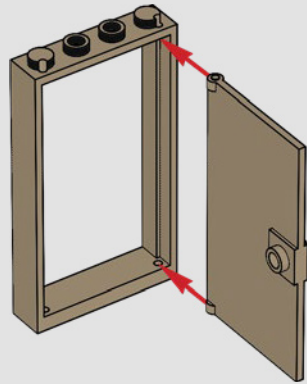

2

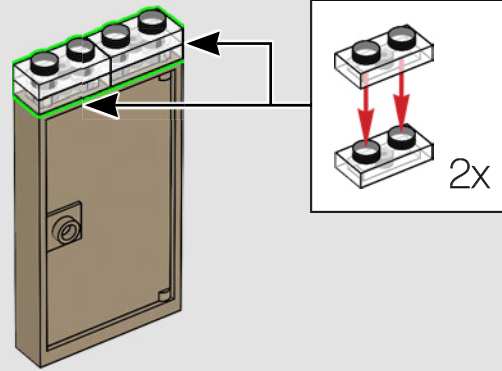

3

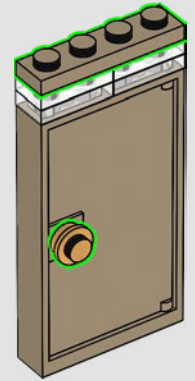

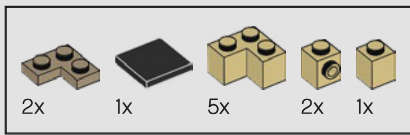

73

1

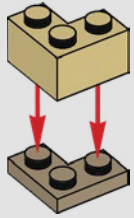

2

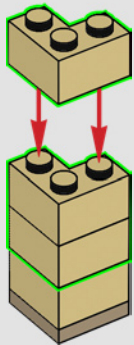

3

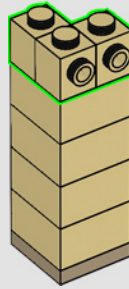

4

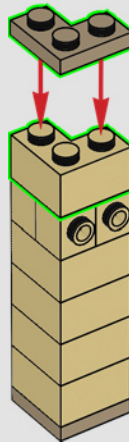

5

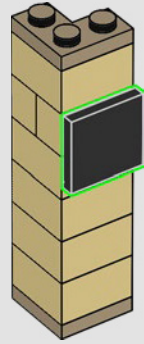

6

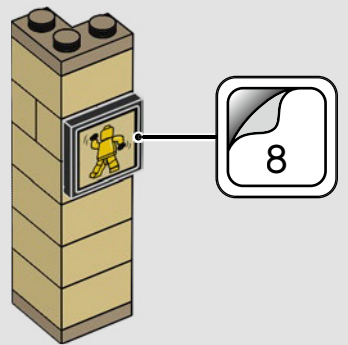



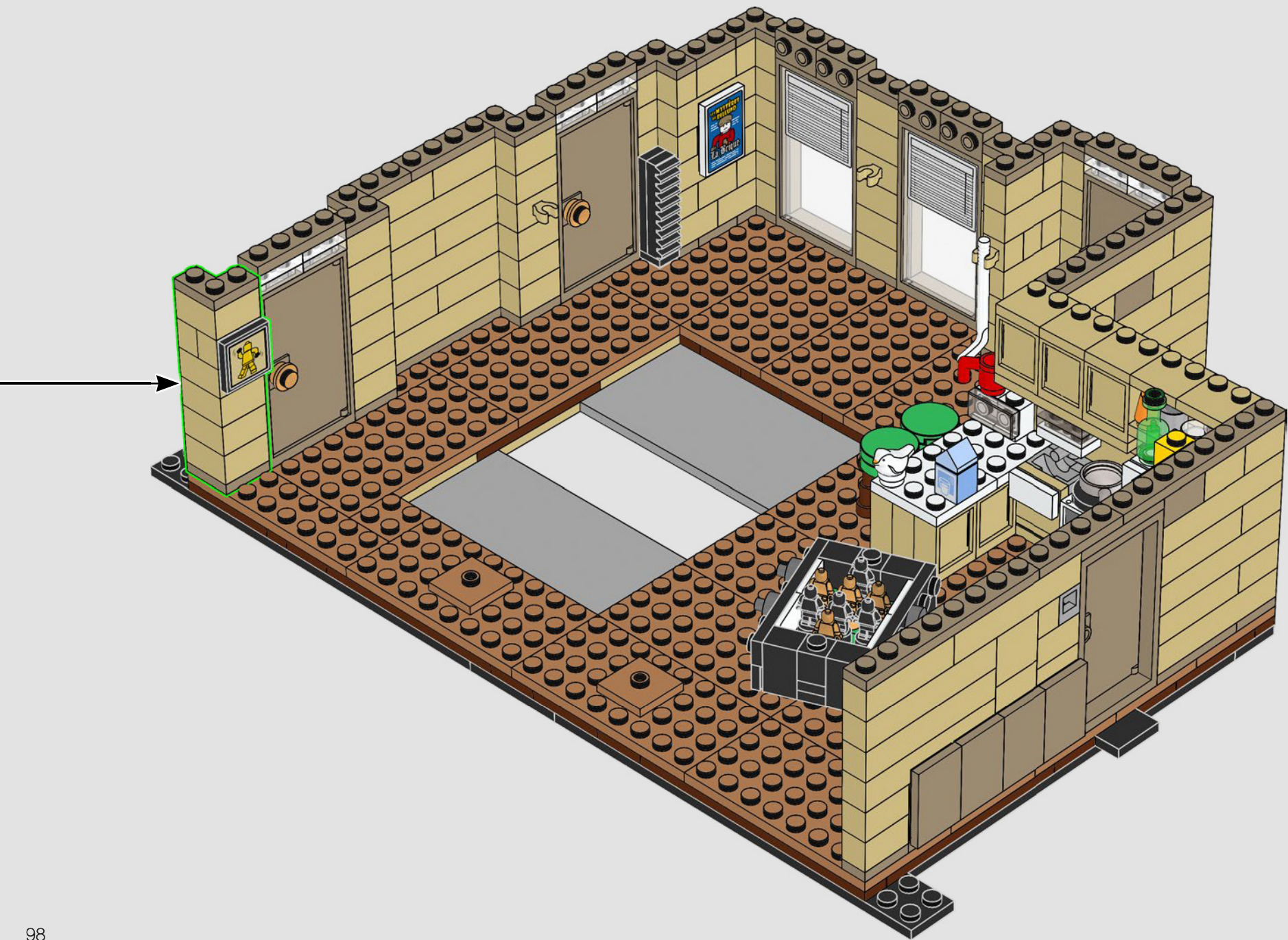



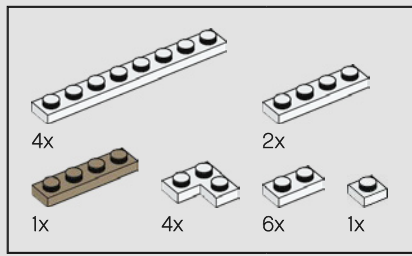

74





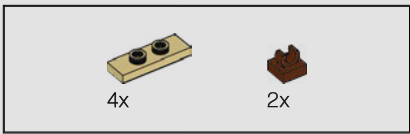

75







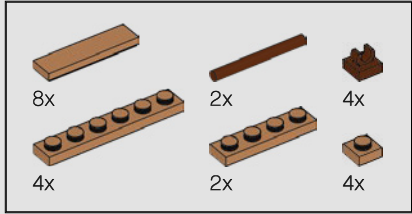
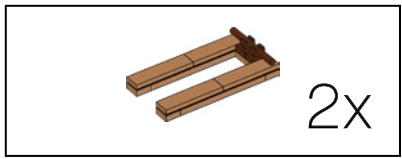

77

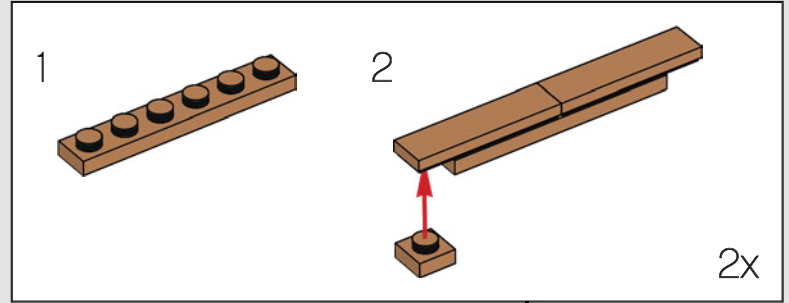
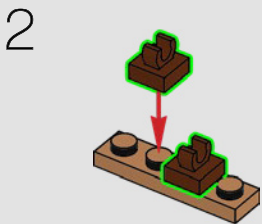
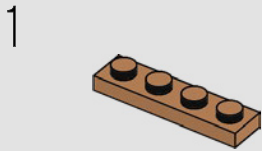

2x

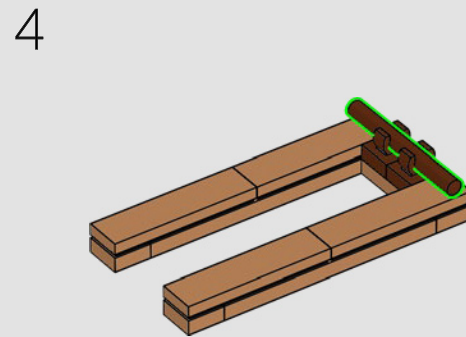
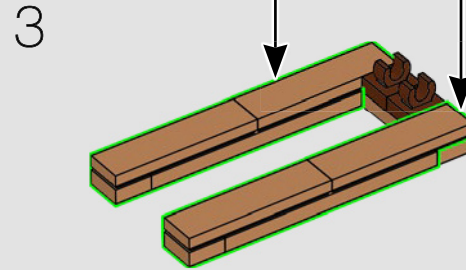

2x



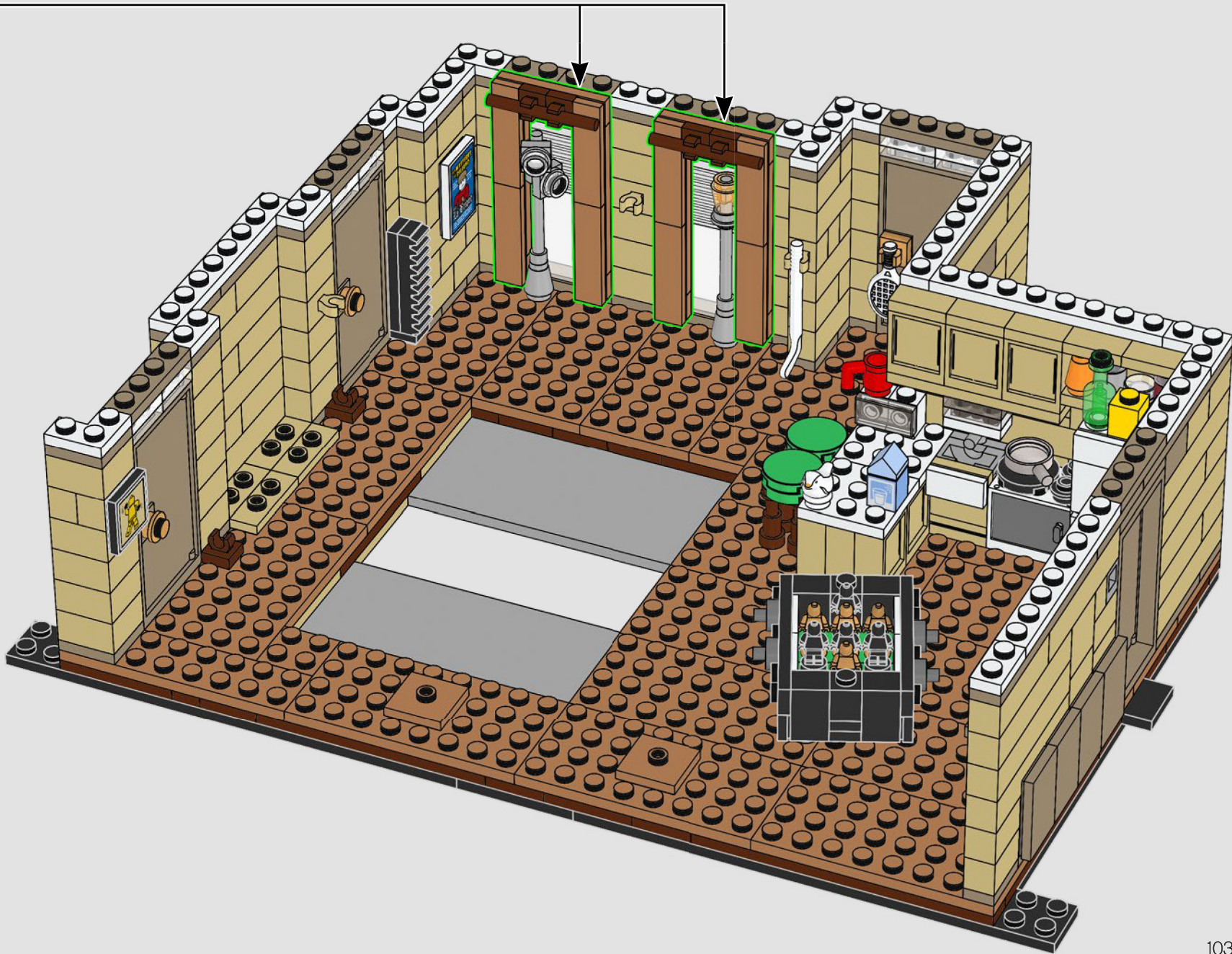



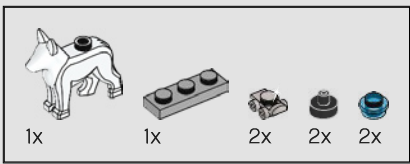

En el rincón hay un perro blanco de cerámica llamado Pat.

78

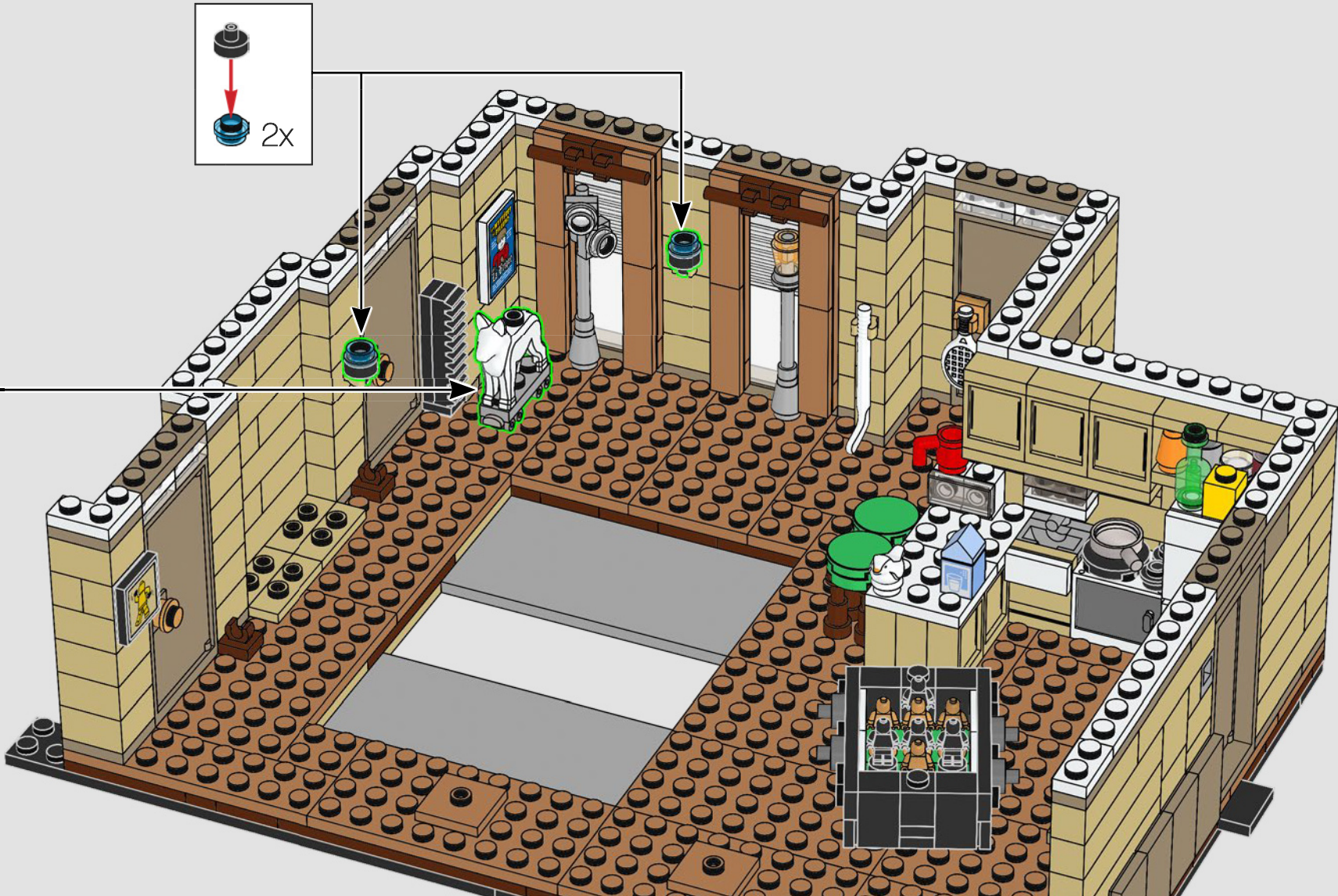
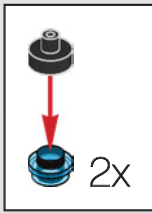
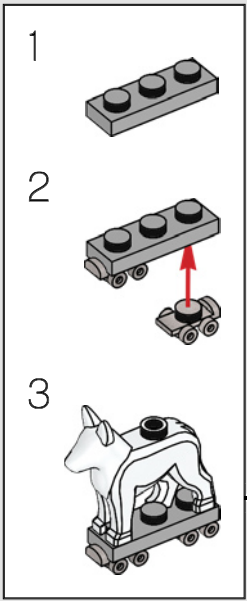

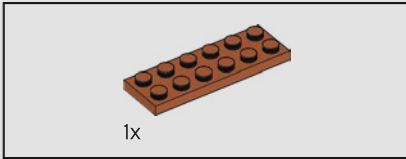
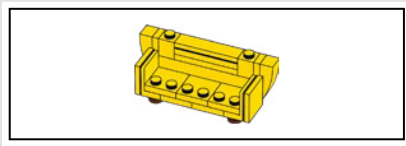

79

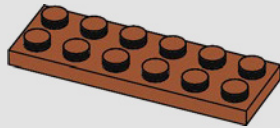

80

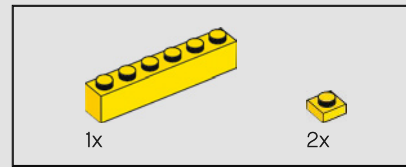
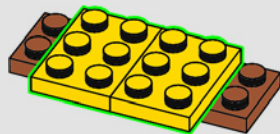

81

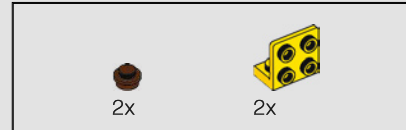
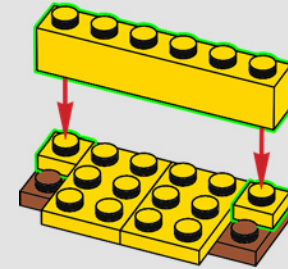

82

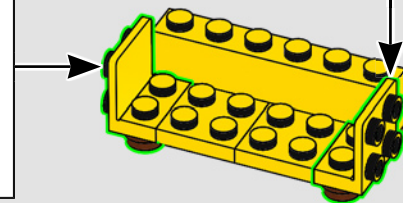
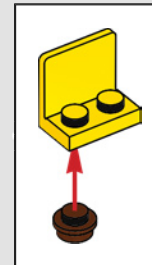
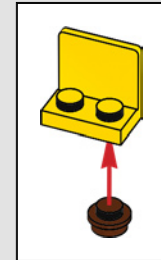

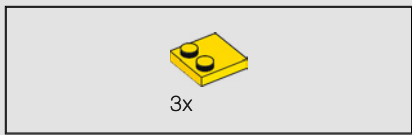

83

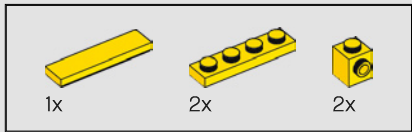
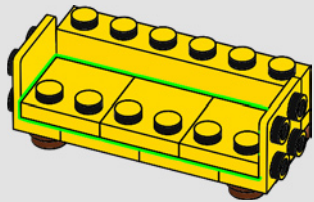

84

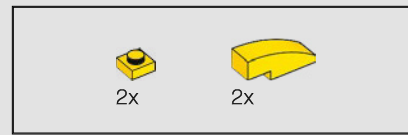
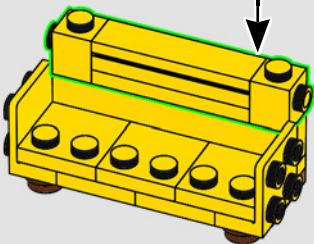
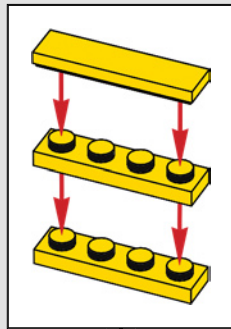

85

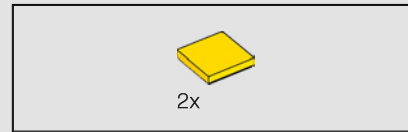
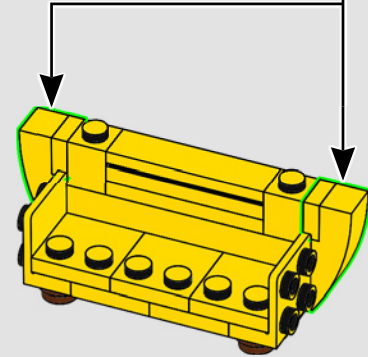
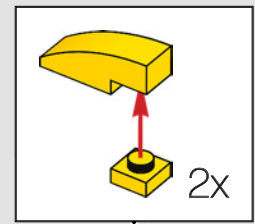

86

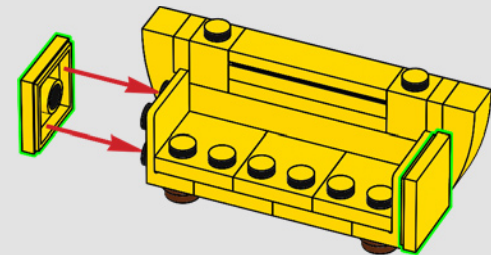



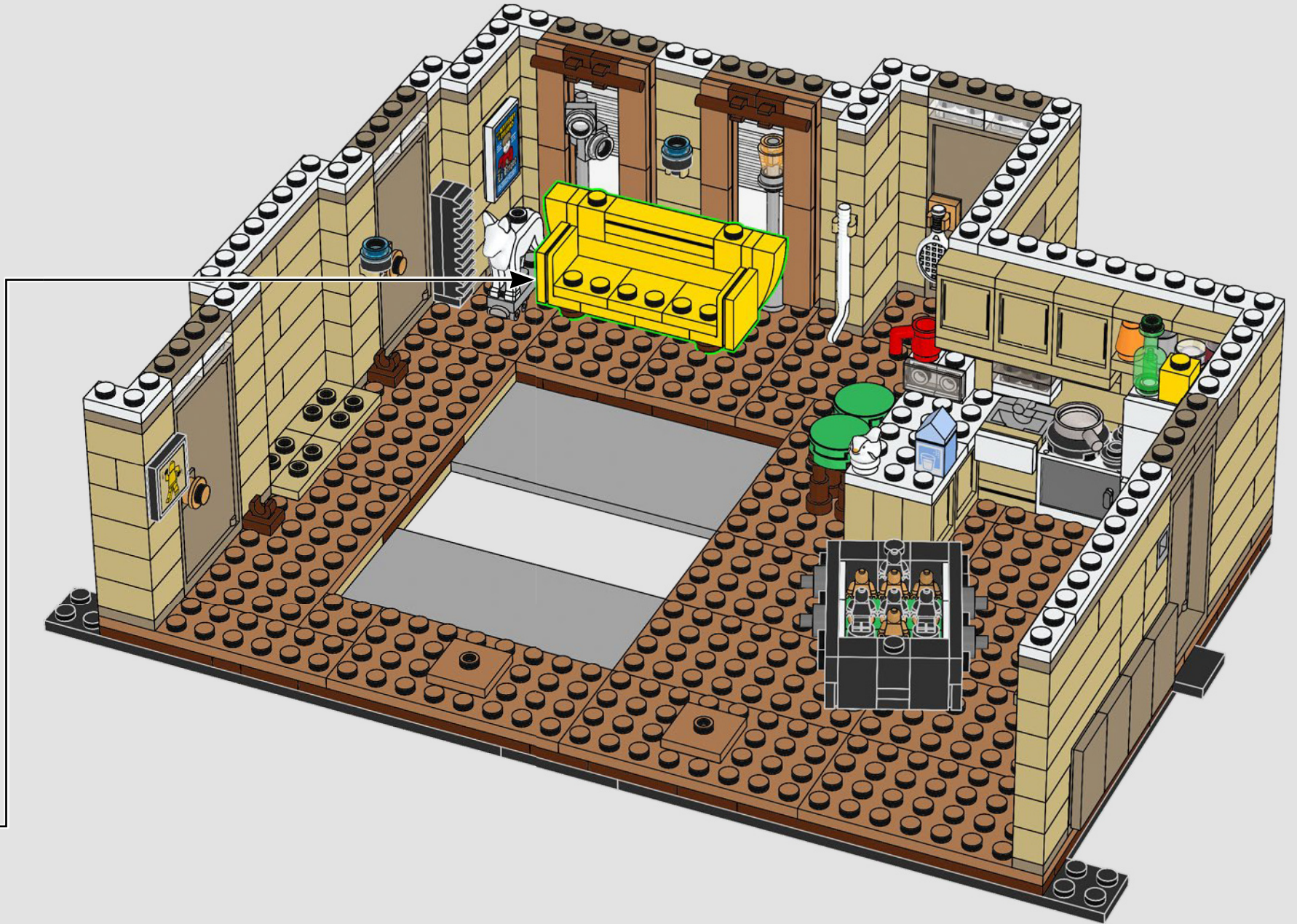

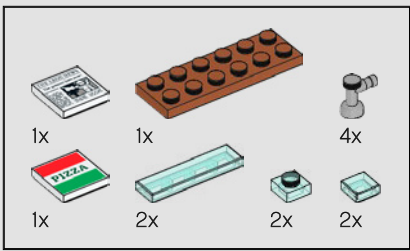

88

1

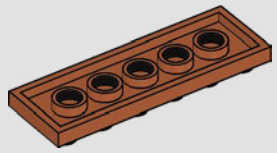

2

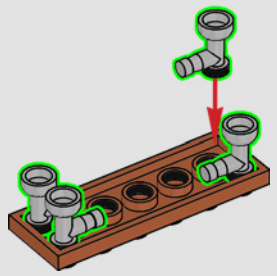

3

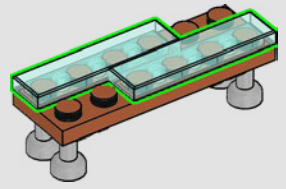
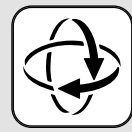

4

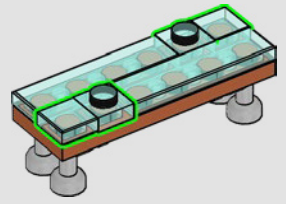

5

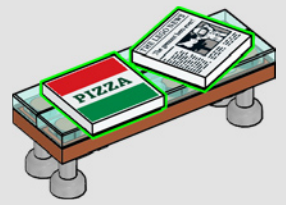



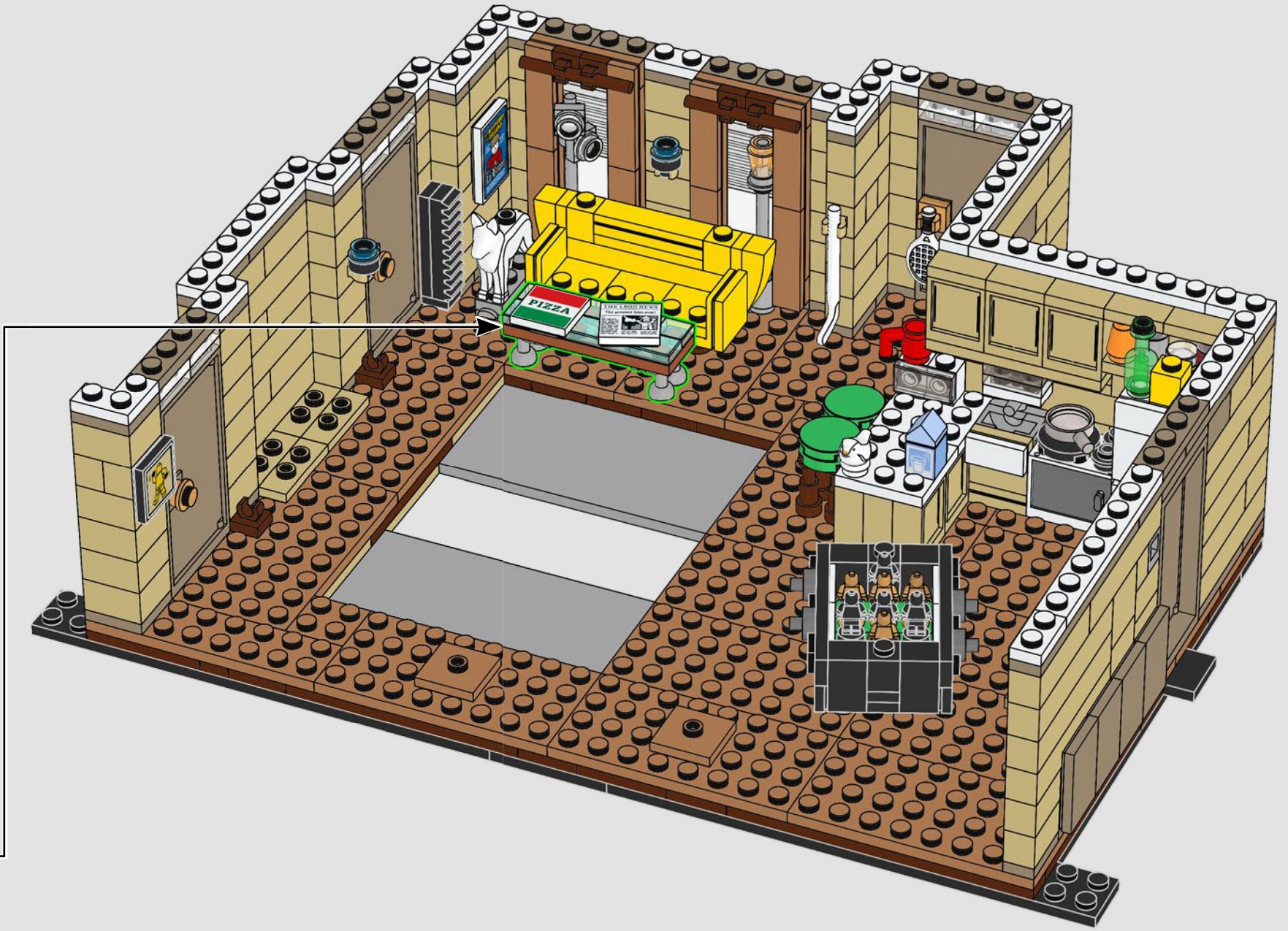



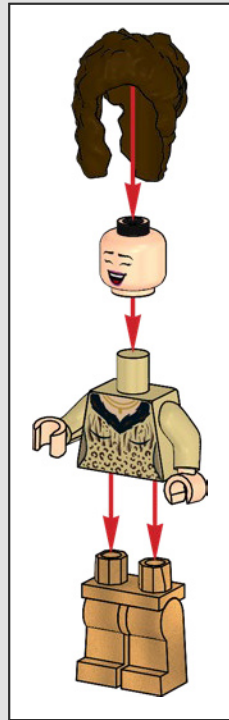
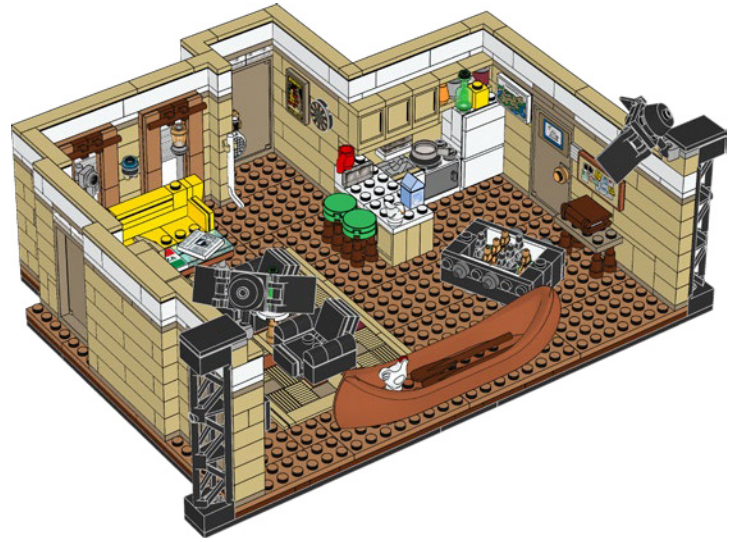
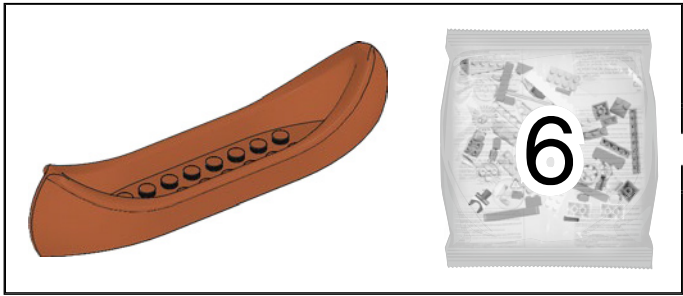

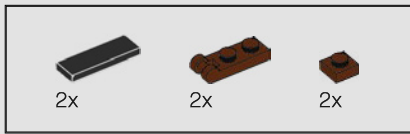

89

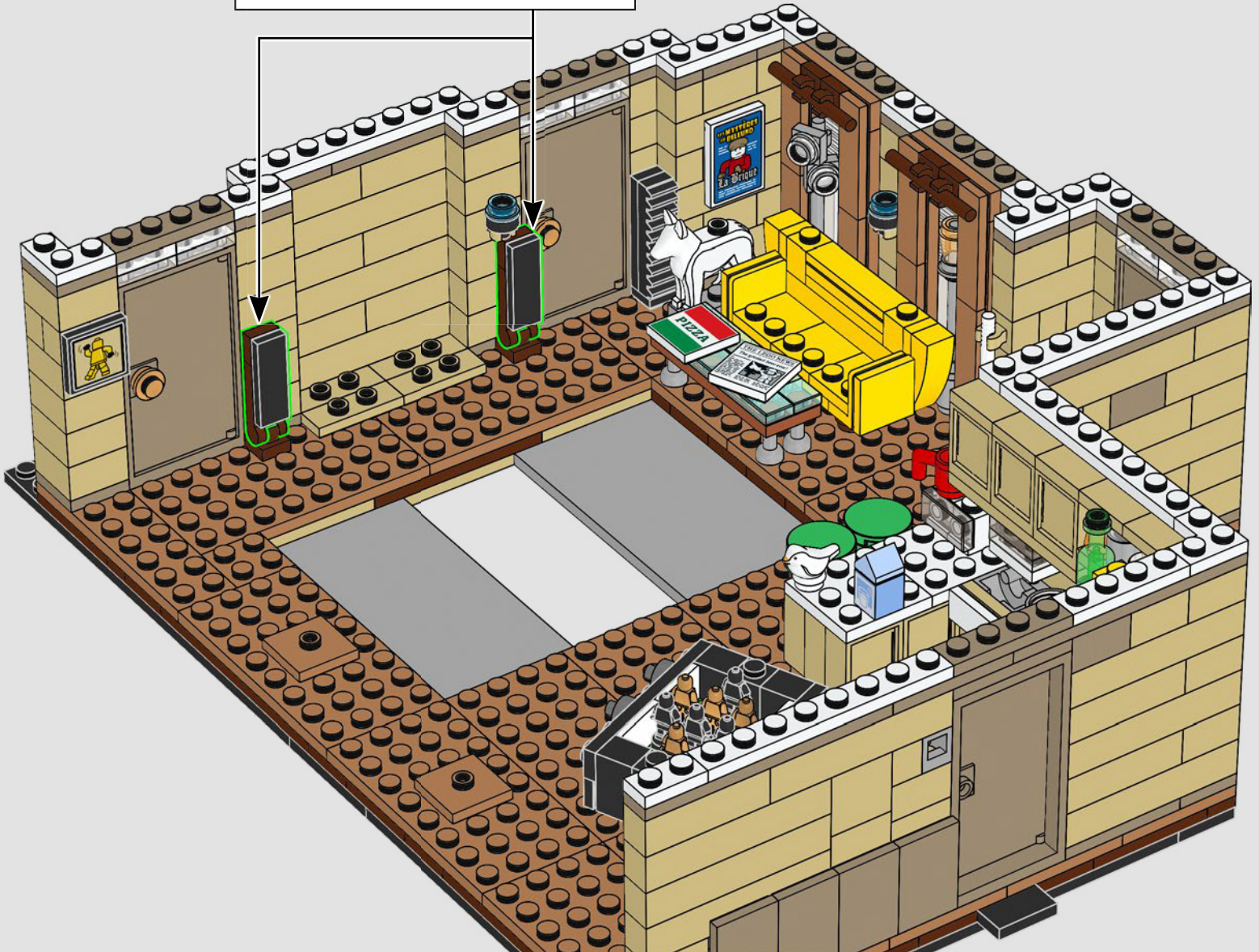
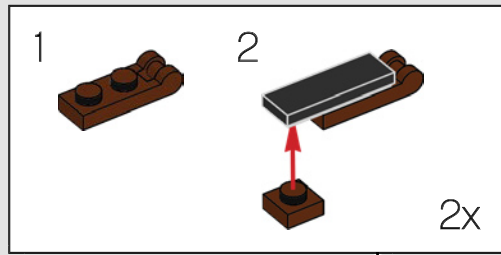



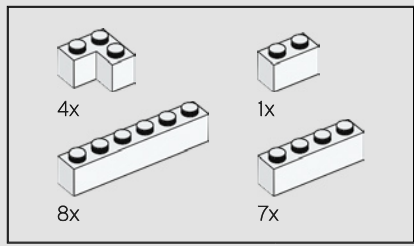

90

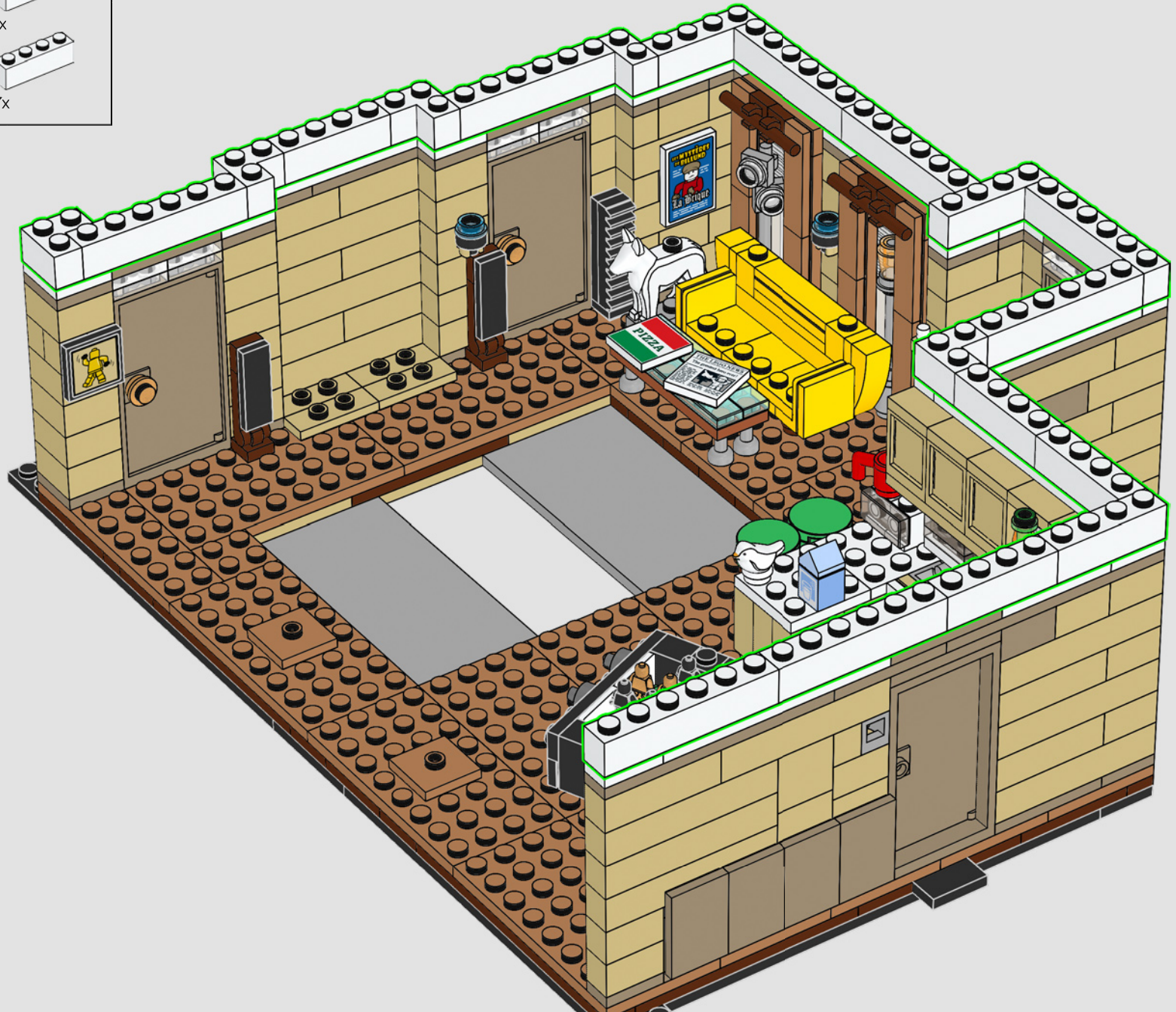



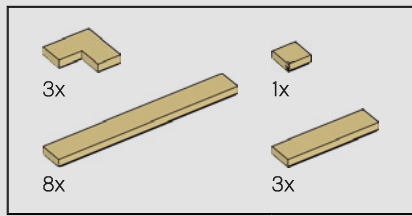

91



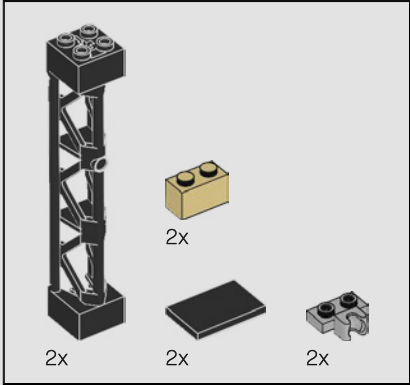
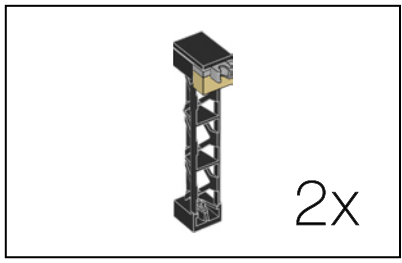

92

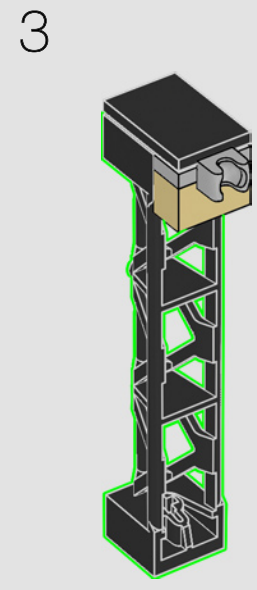
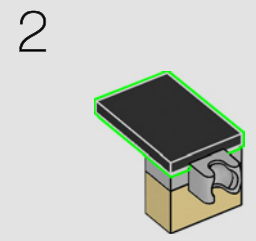
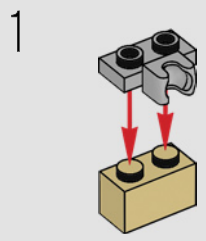







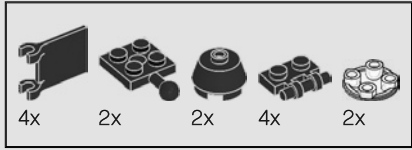
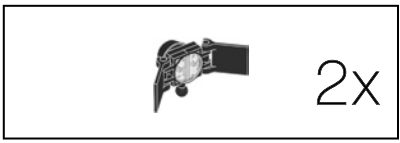

93

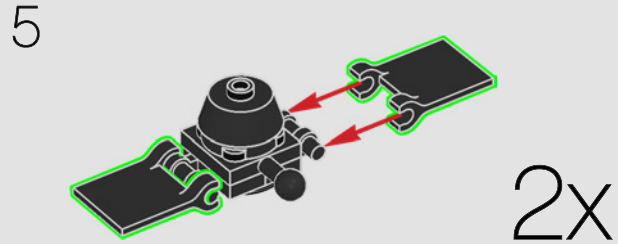
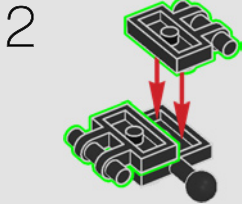

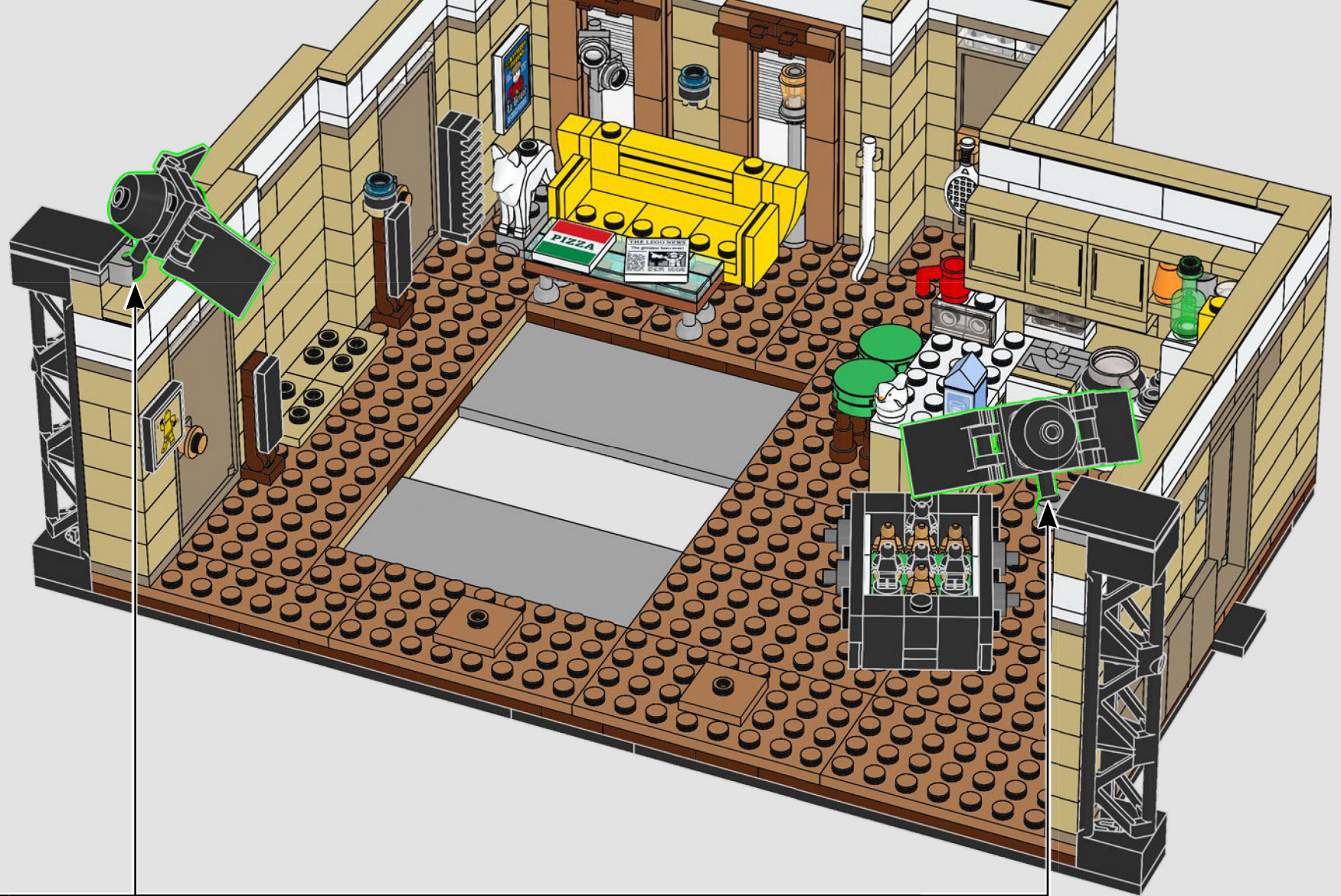

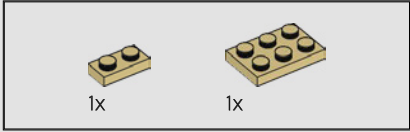
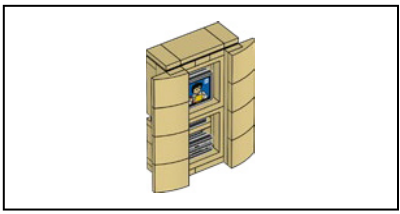

94

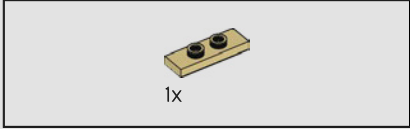
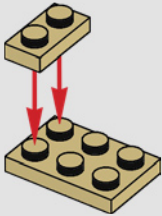

95

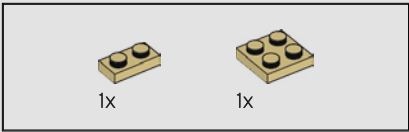
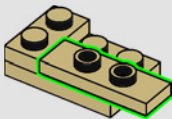

96

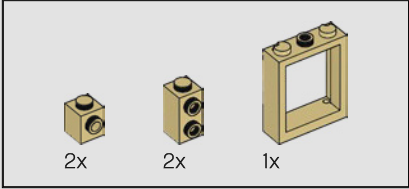
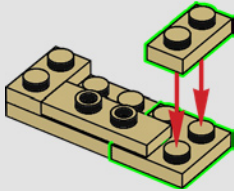

97

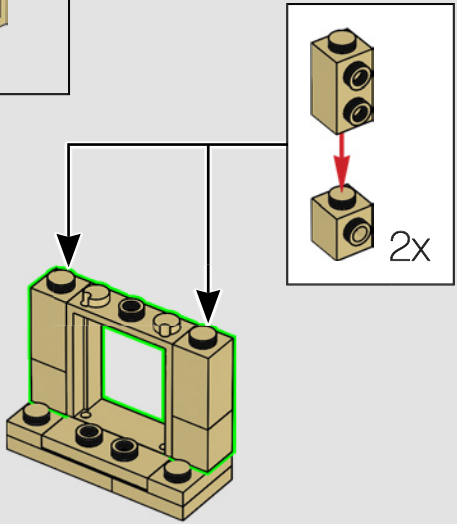



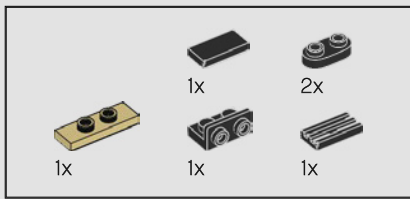

98

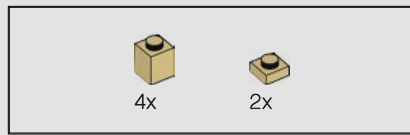
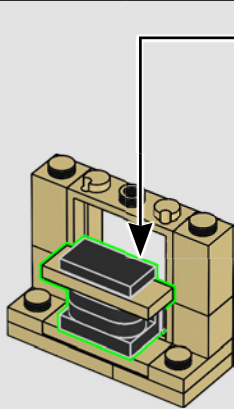
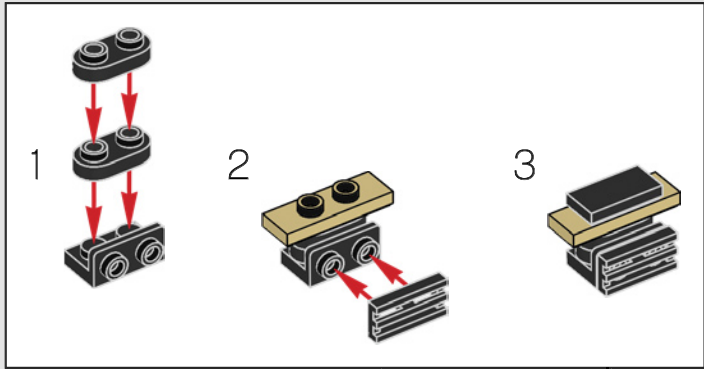

99

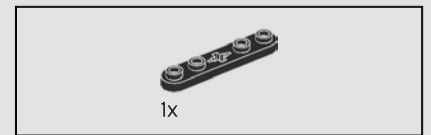
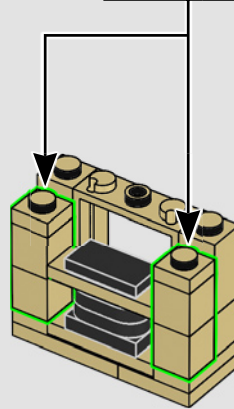
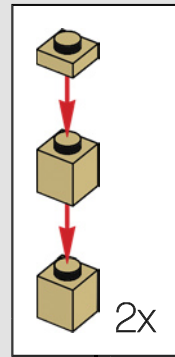

100

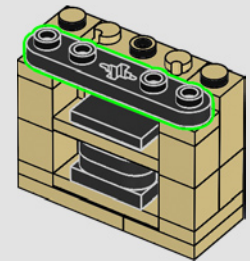

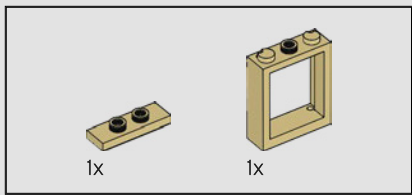

101

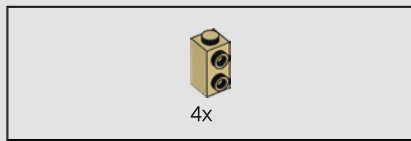
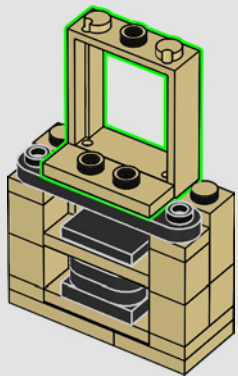

102

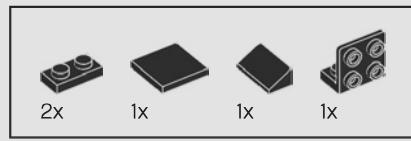
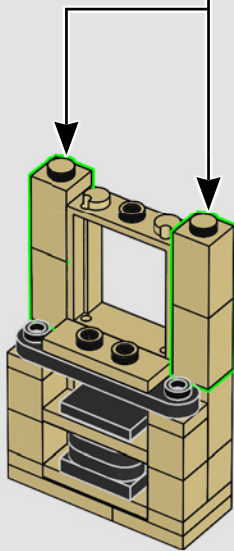
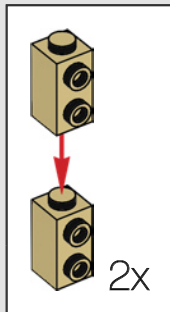

103

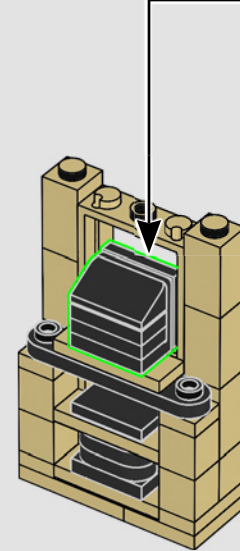
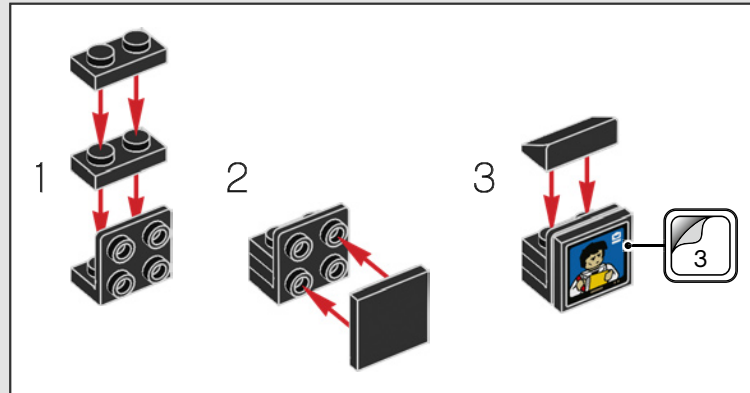

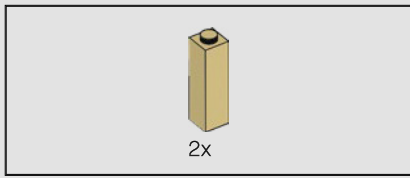

104

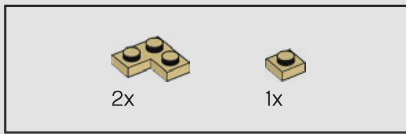
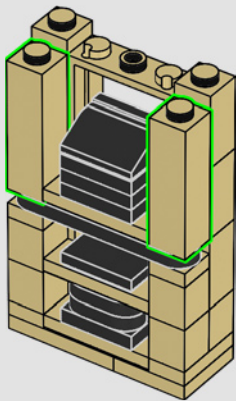

105

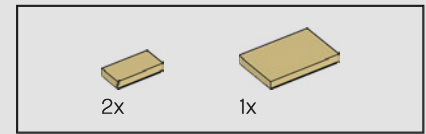
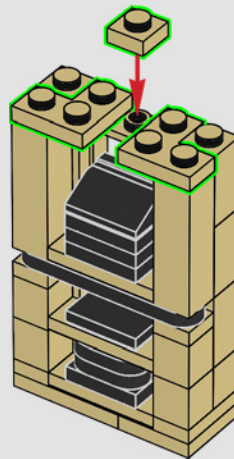

106

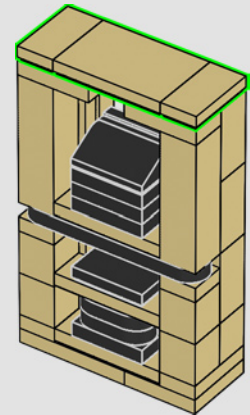



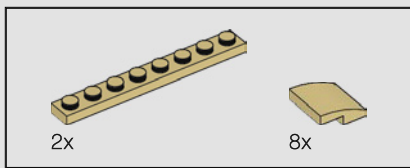

107

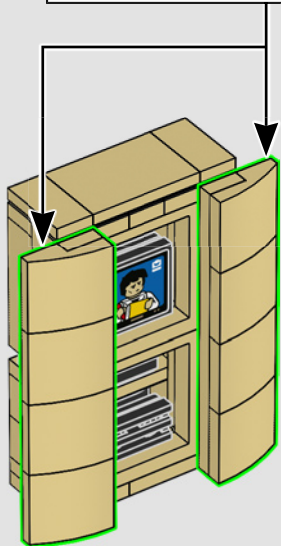
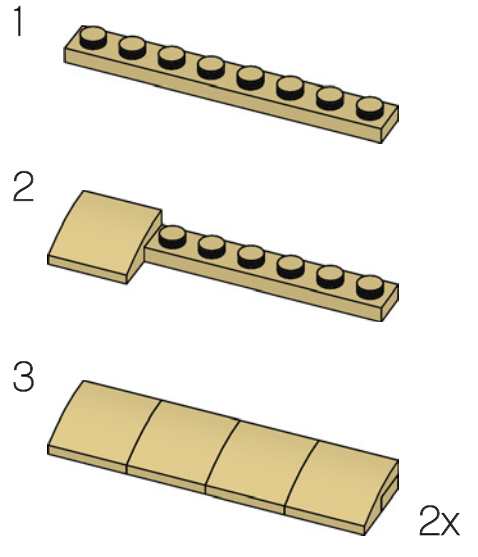

● La calcomanía de la pantalla del televisor representa a Joey en el papel del Dr. Drake Ramoray, su primera y más famosa actuación en un culebrón televisivo.



108



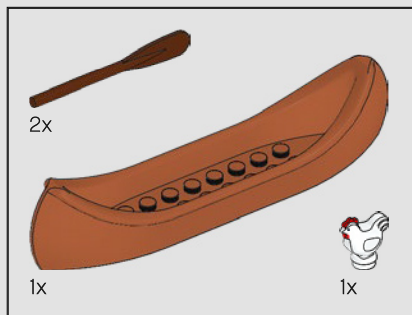

109

La canoa de madera es en recuerdo de la que Joey y Chandler se vieron forzados a adquirir después de que les robaran todos los muebles de su apartamento.



1

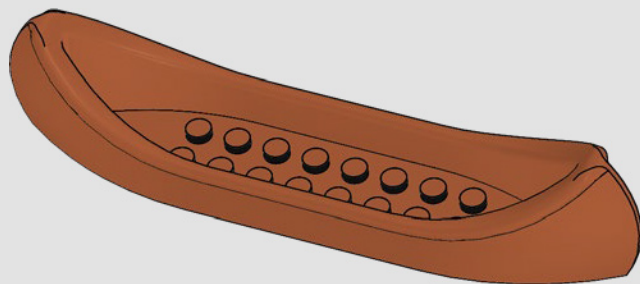

2

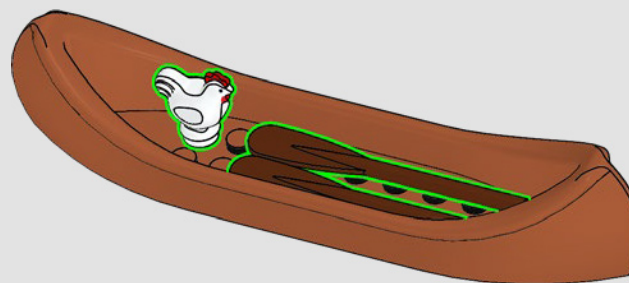



● El pato y el pollo representan los que Chandler y Joey adoptan y crían a lo largo del tiempo.

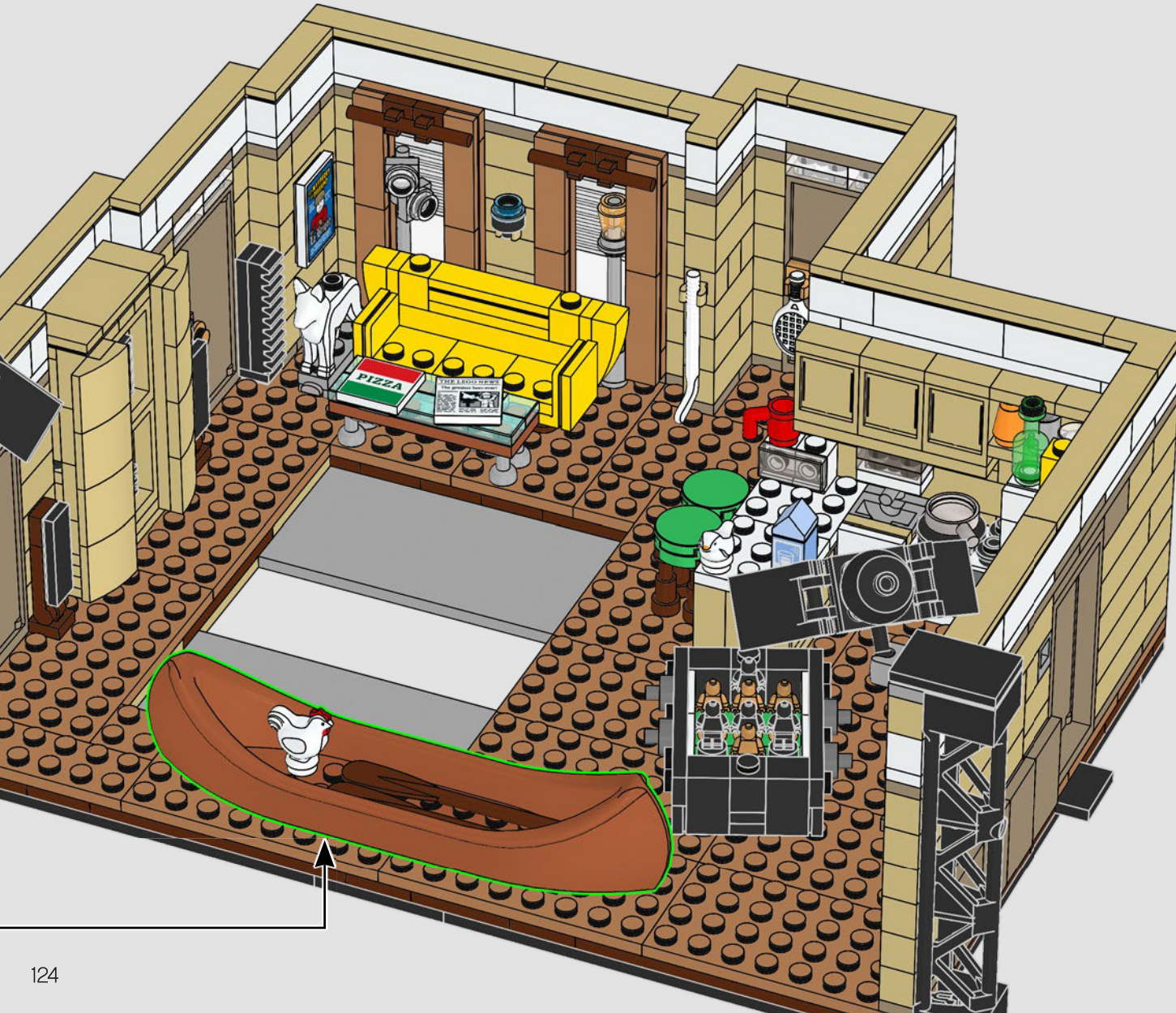



110

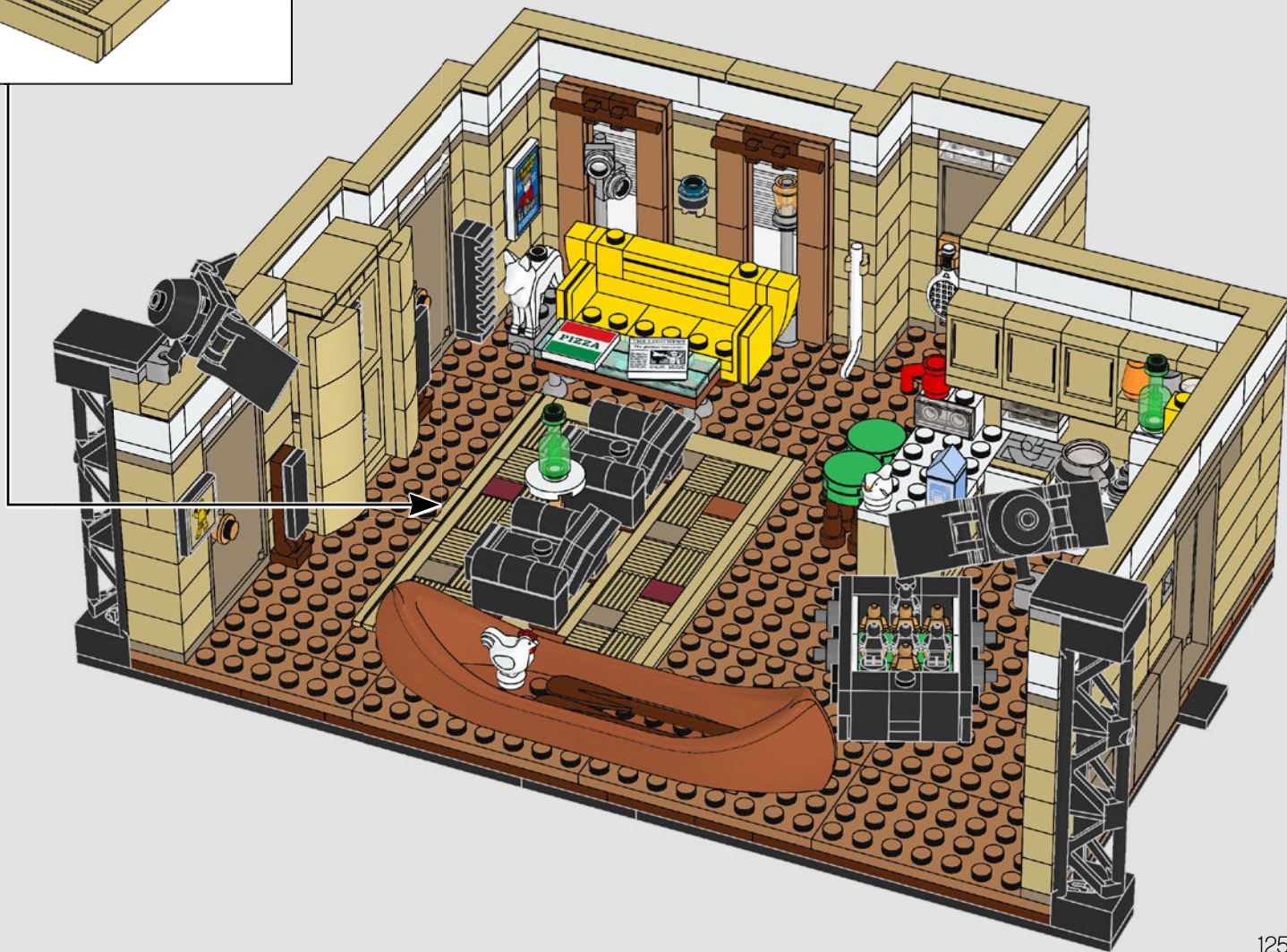
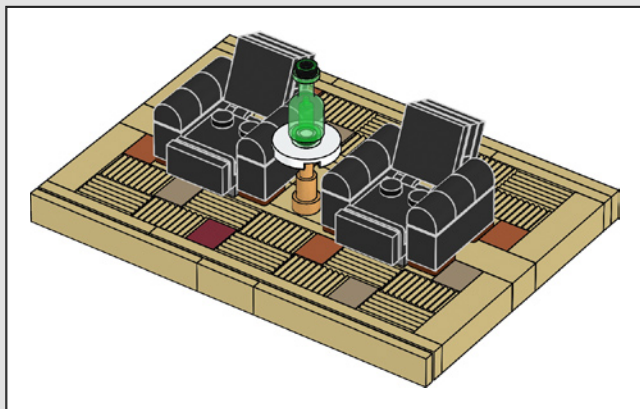

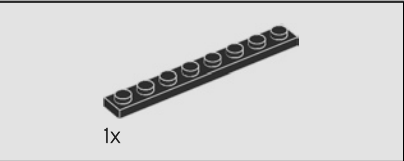
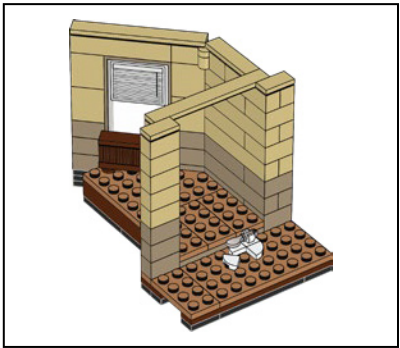
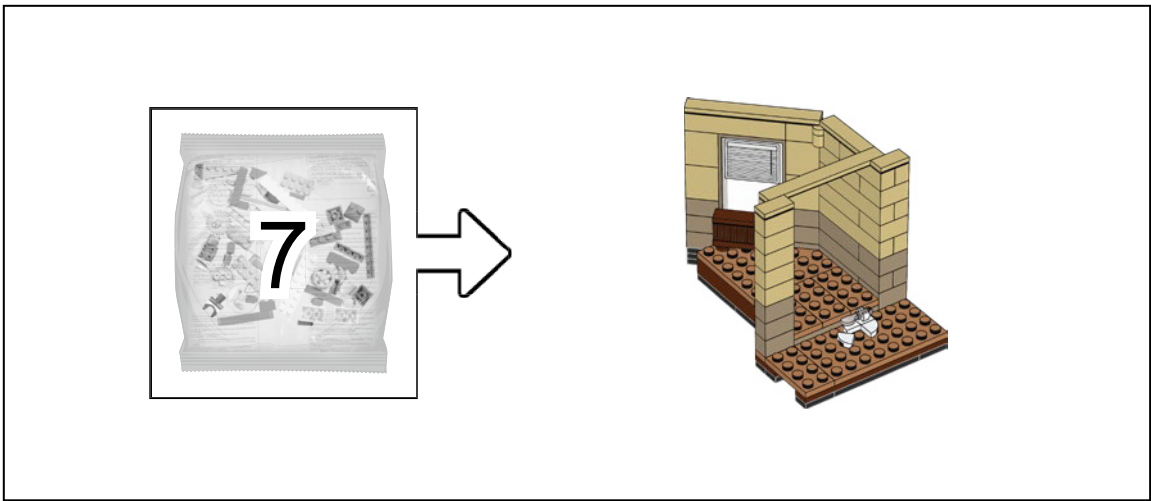

1

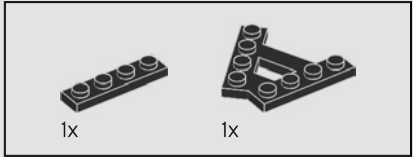
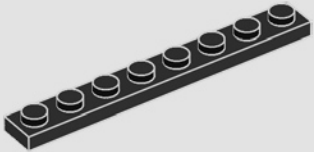

2

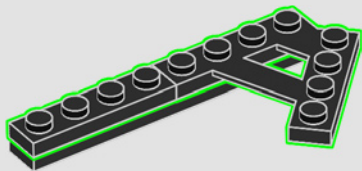

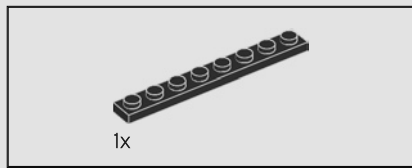

3

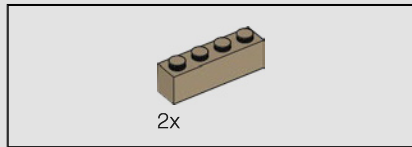
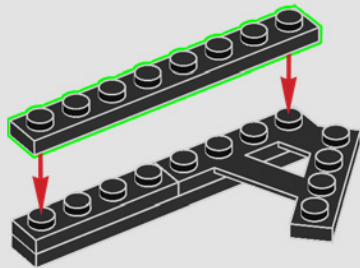

4

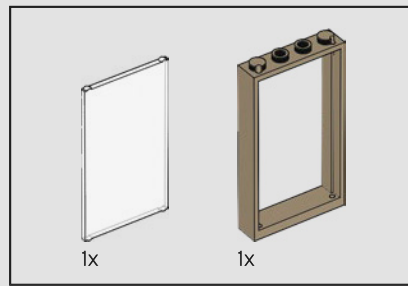
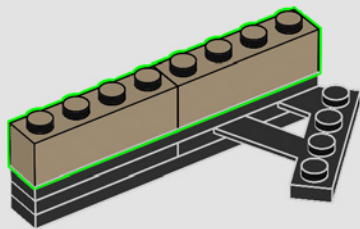

5

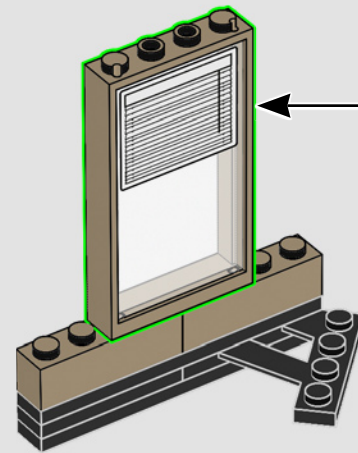
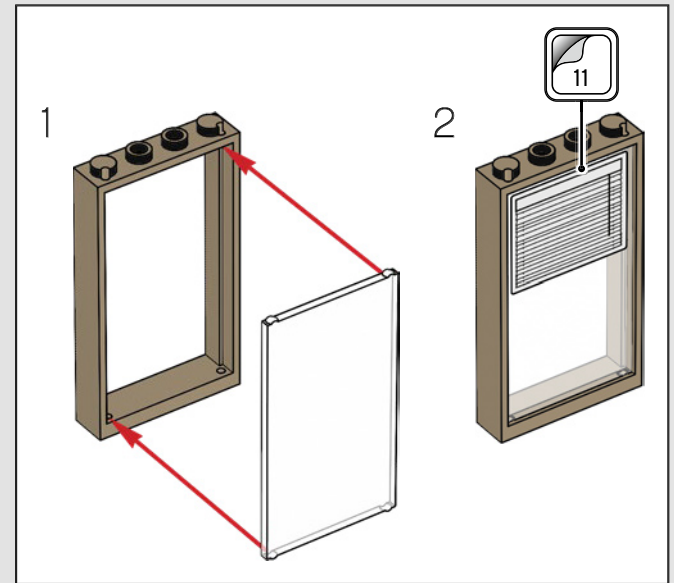



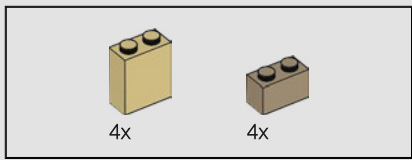

6

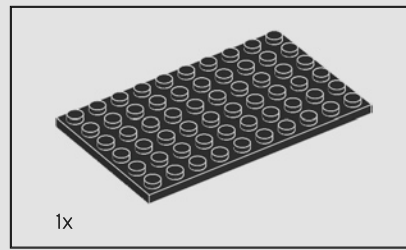
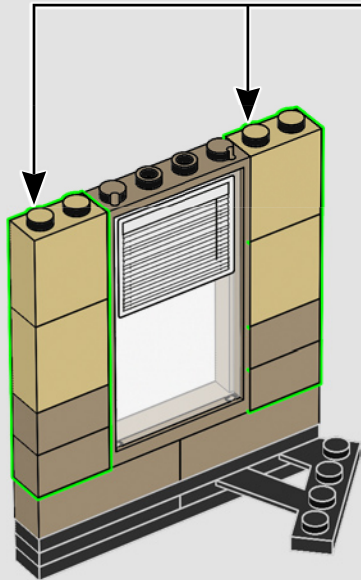
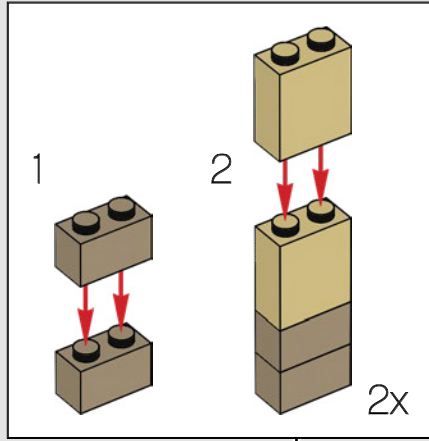

7

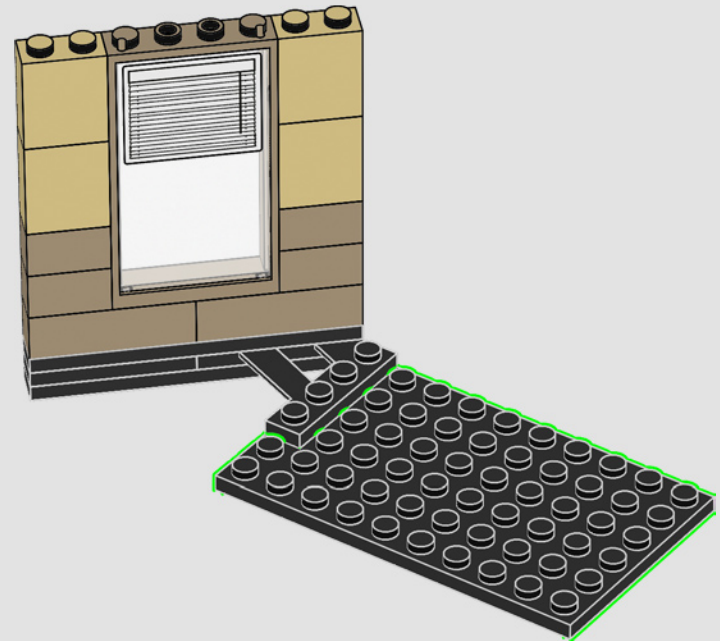

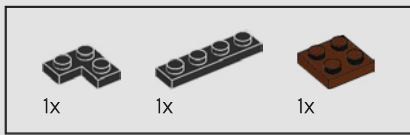

8

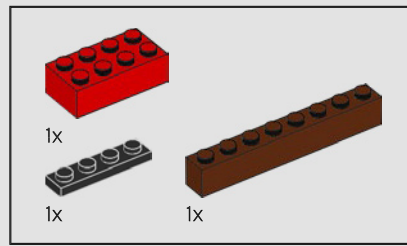
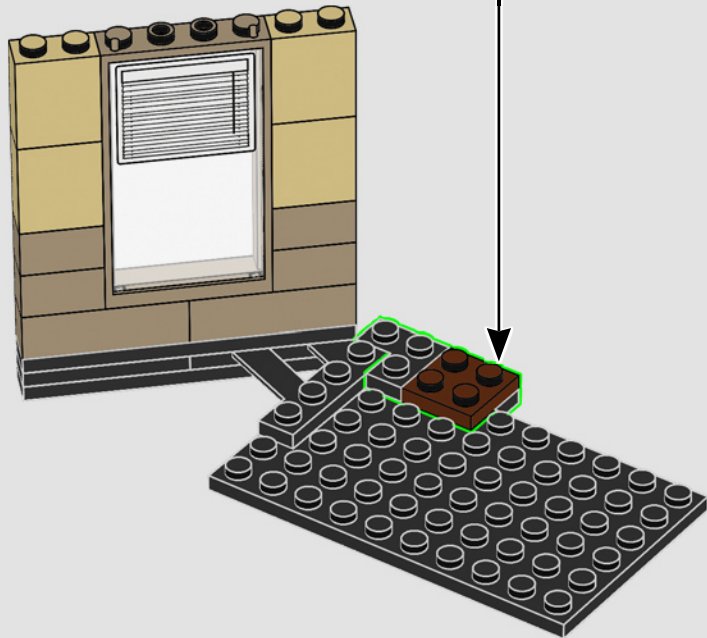
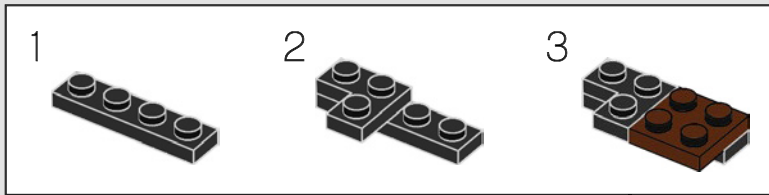

9

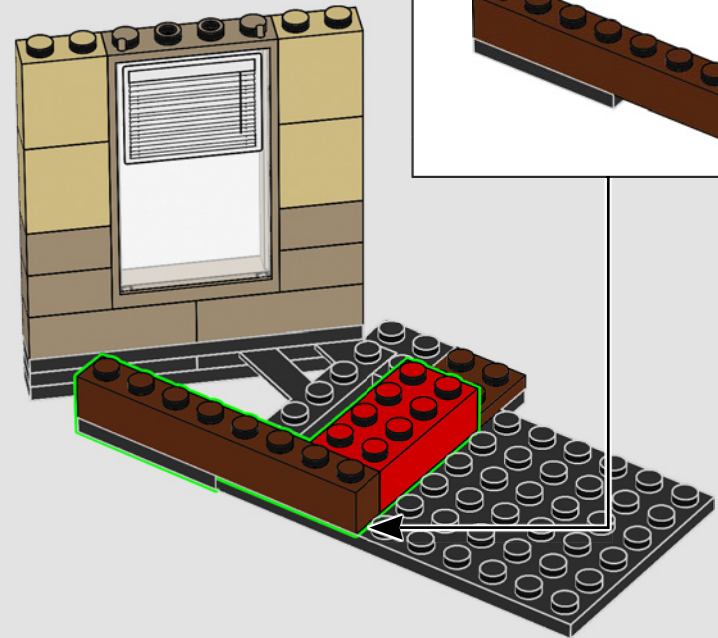
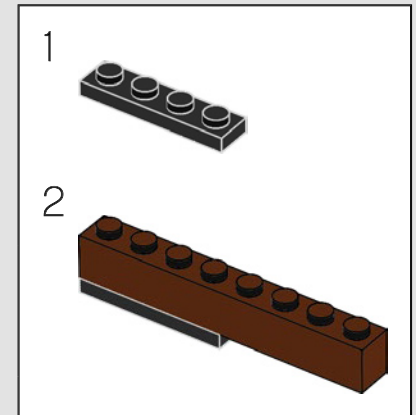

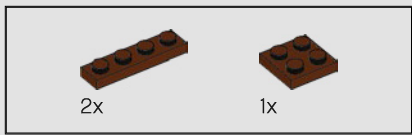

10

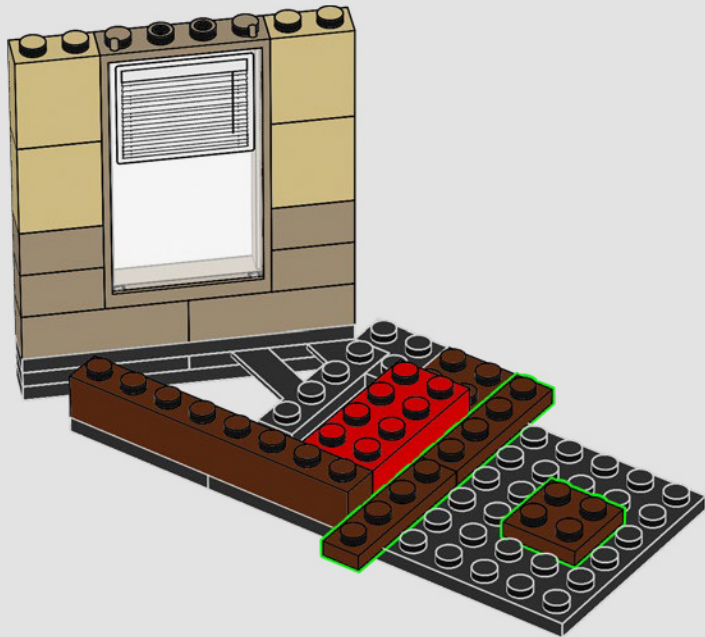

11

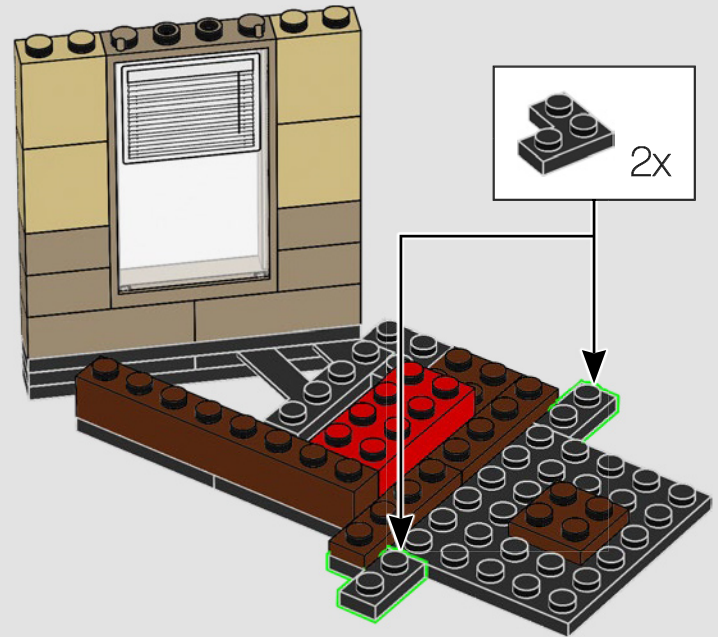





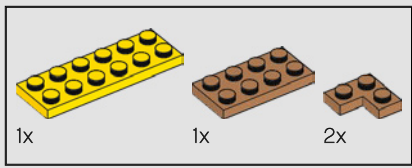

13

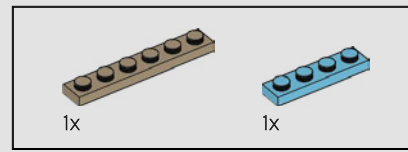

14

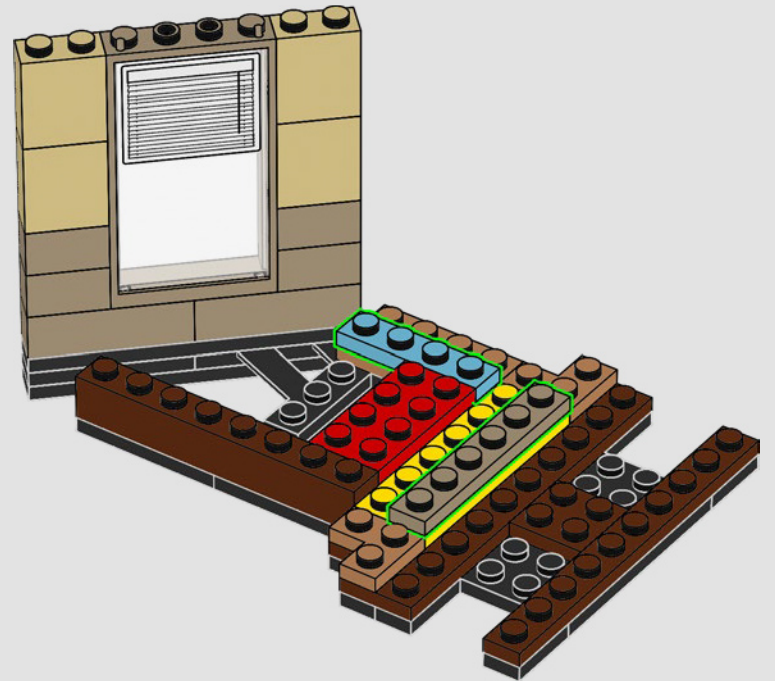

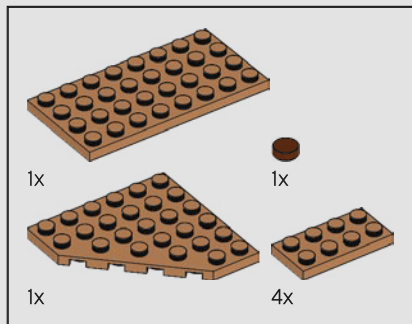

15

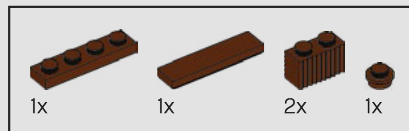
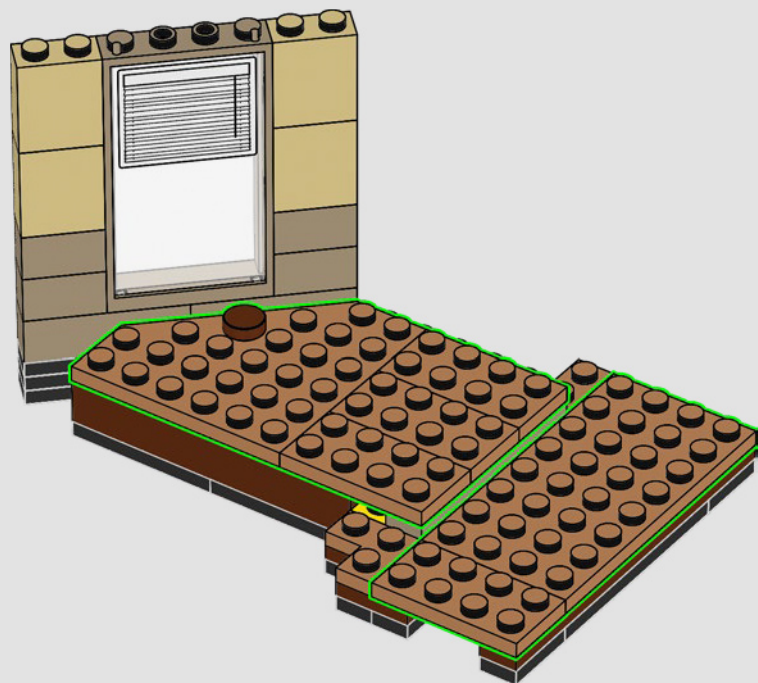

16

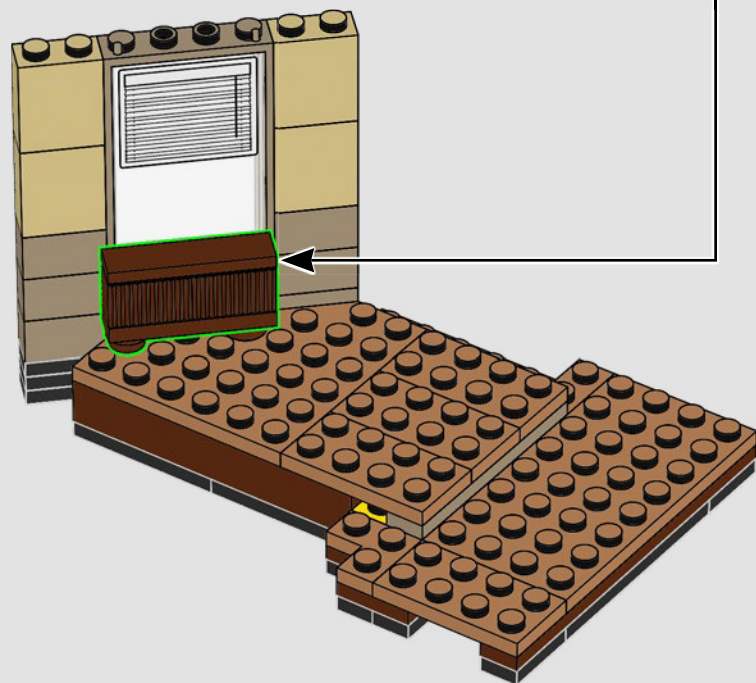
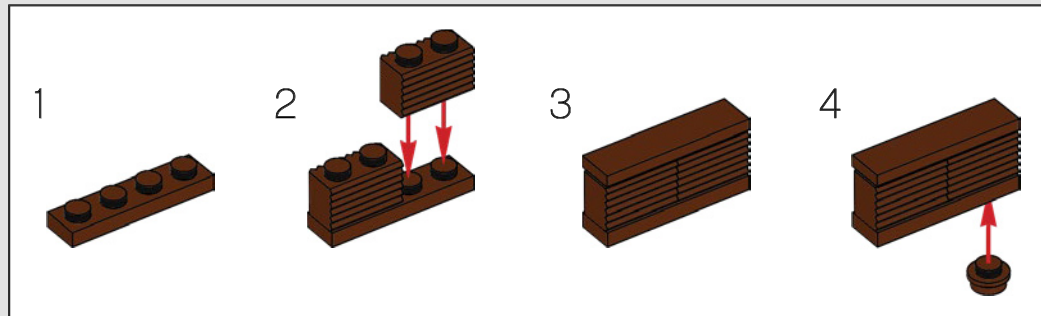



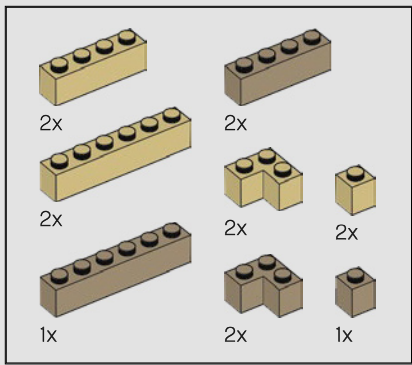

17

1

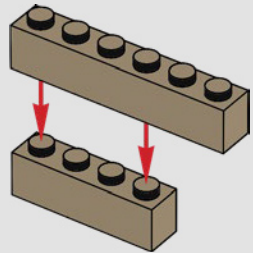

2

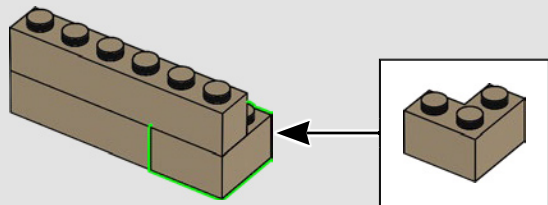

3

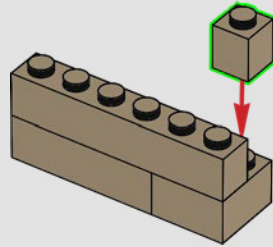

4

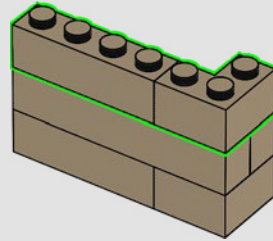

5

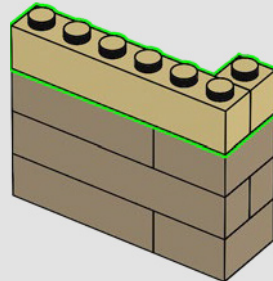

6

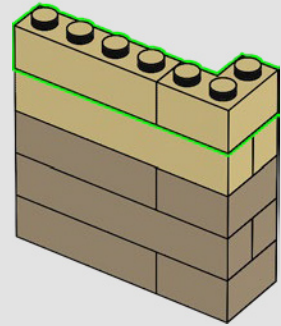

7

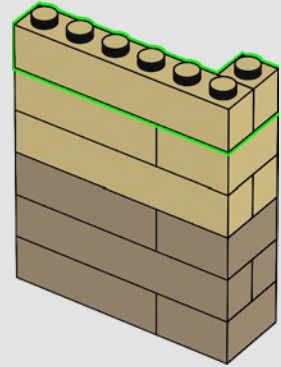

8

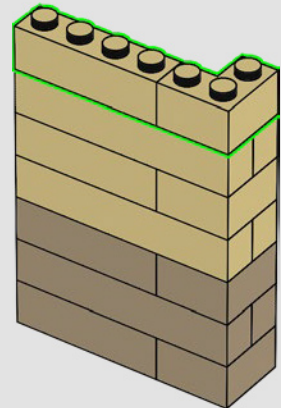

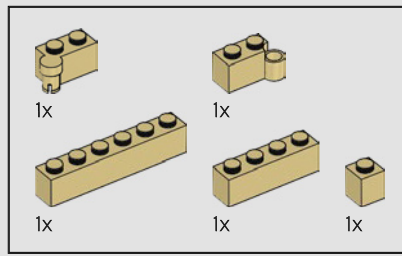

18

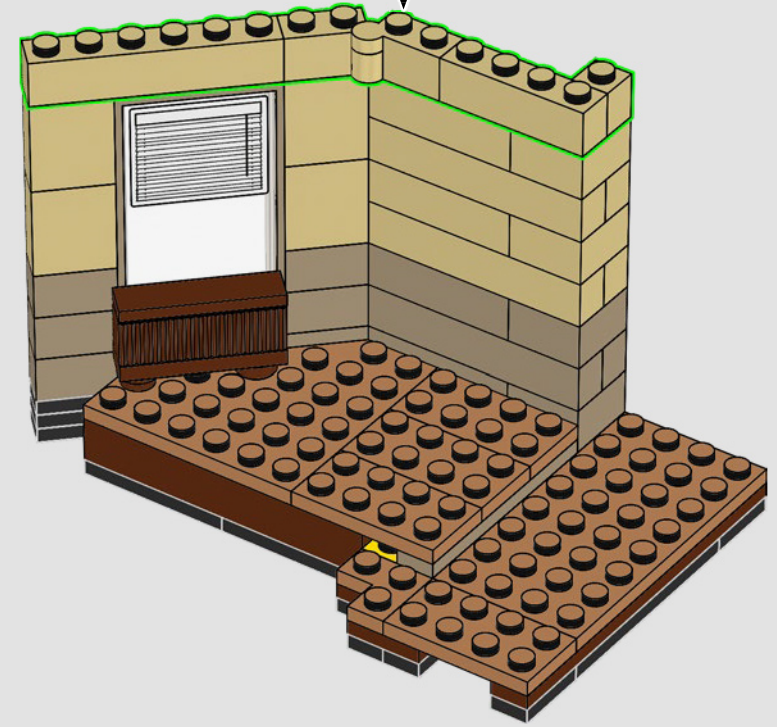
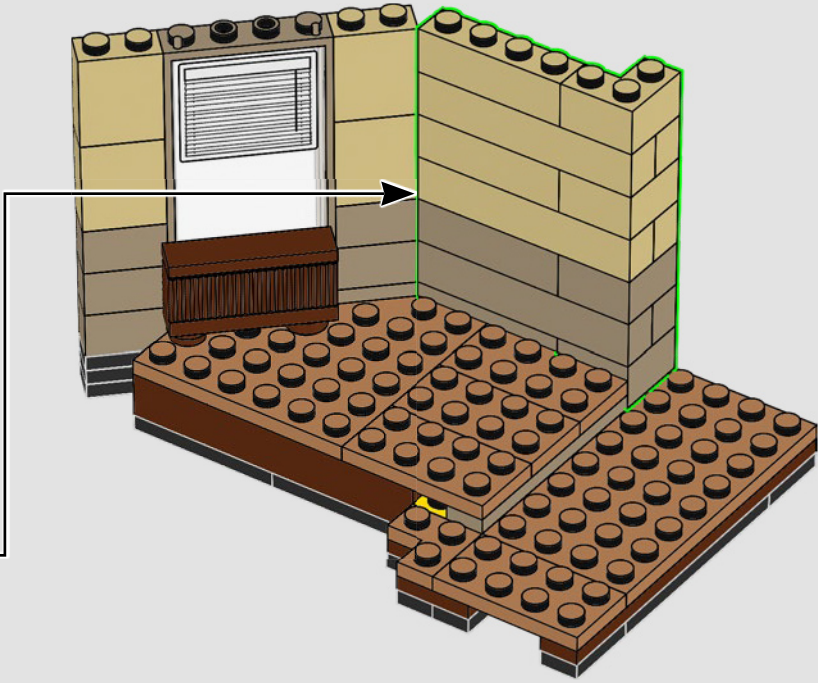
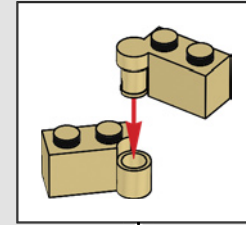

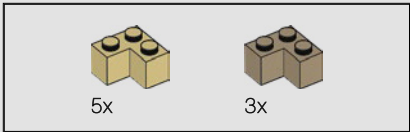

19

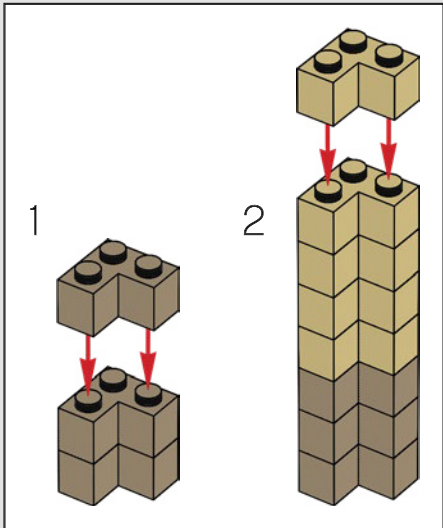



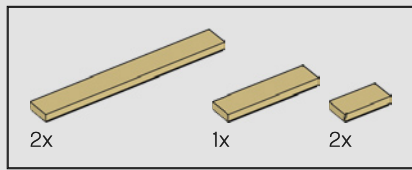

20

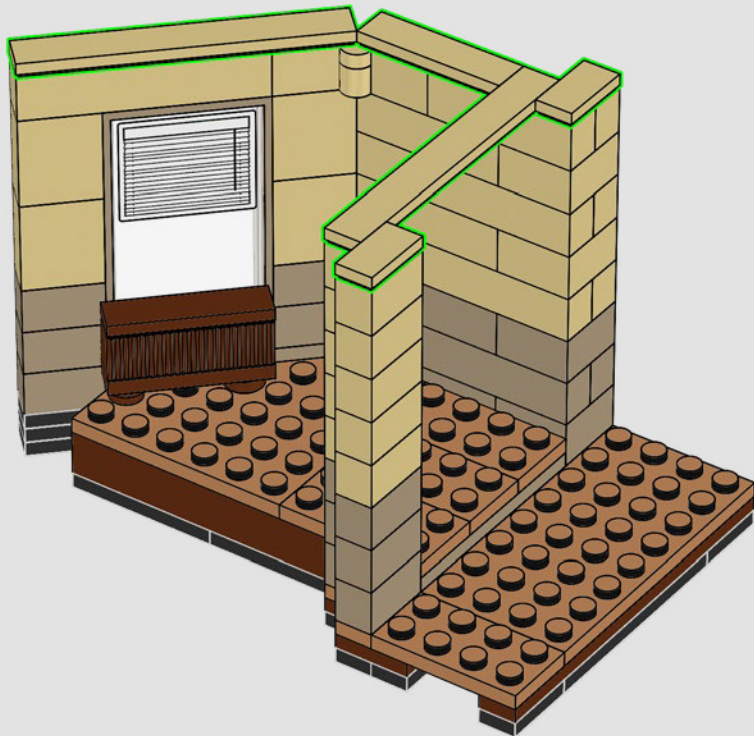

21

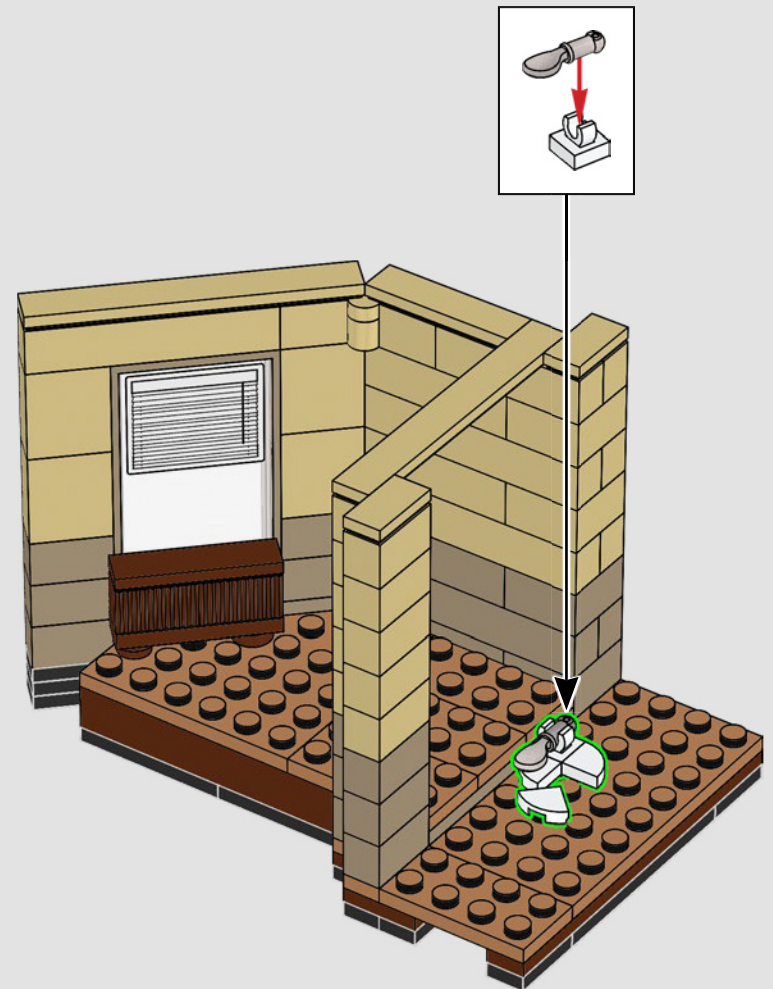



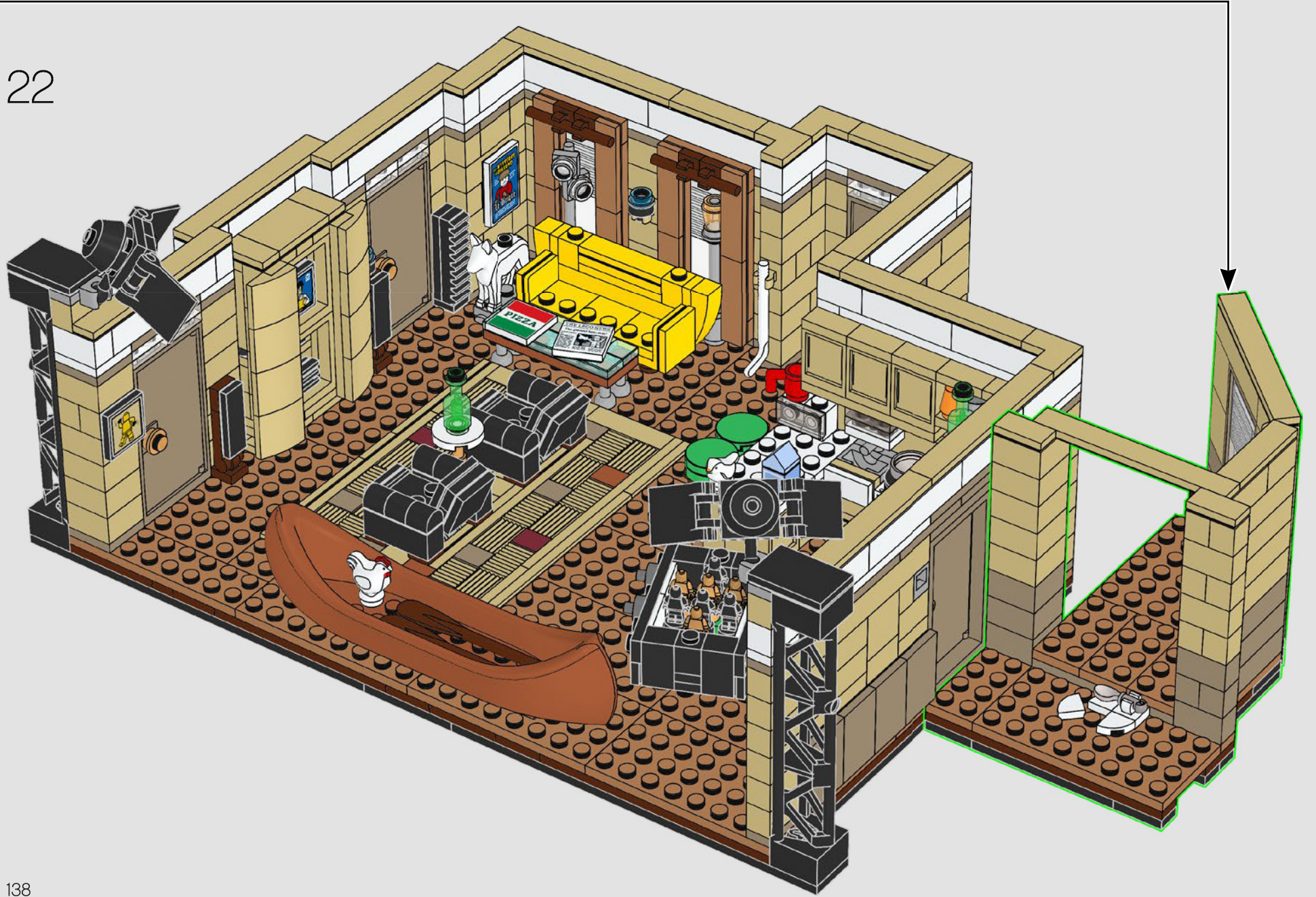

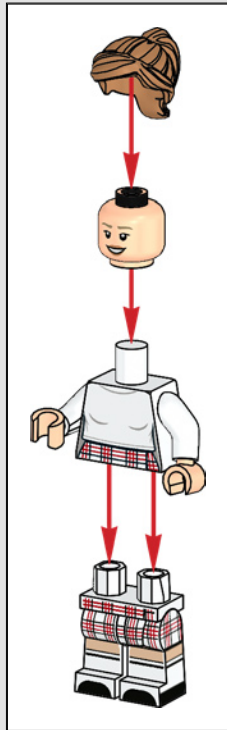
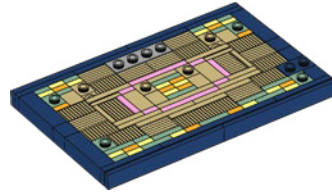



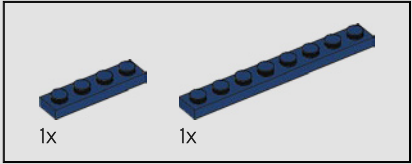
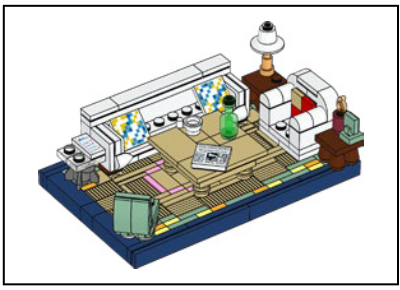

1

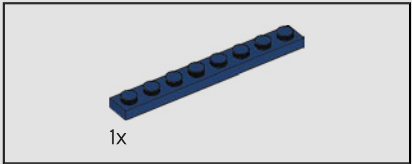
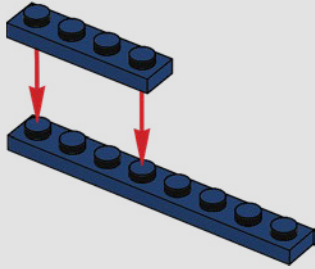

2

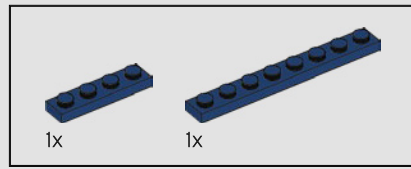
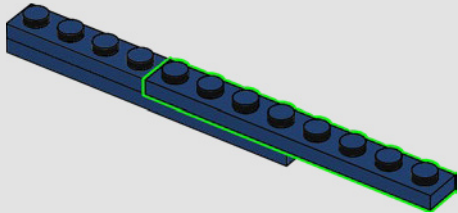

3

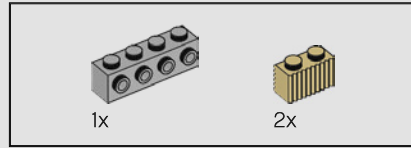
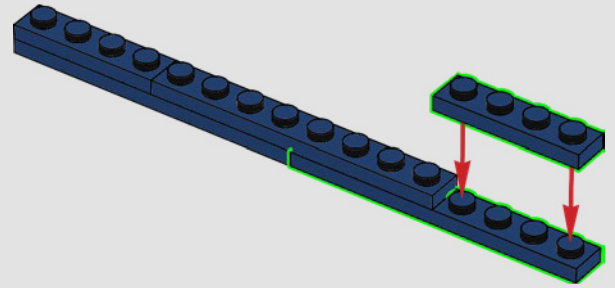

4

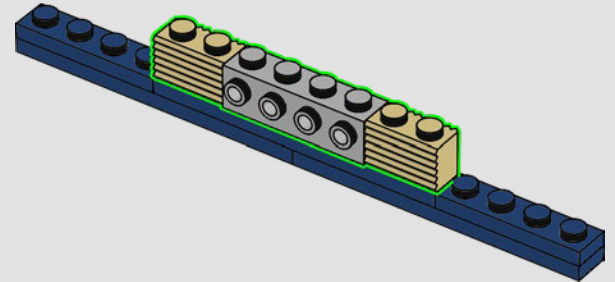

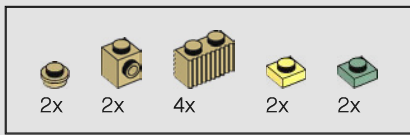

5

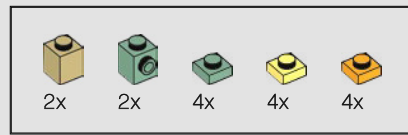
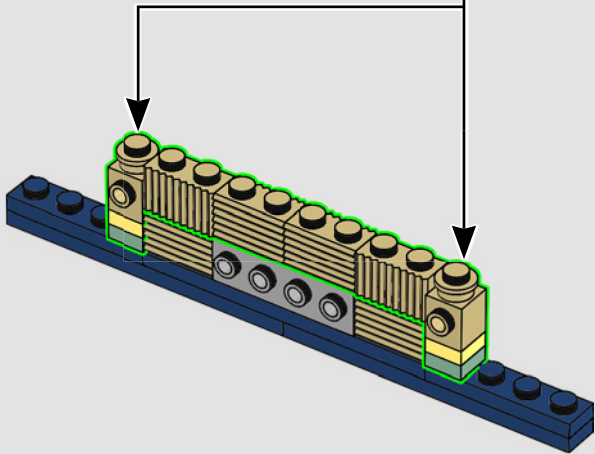
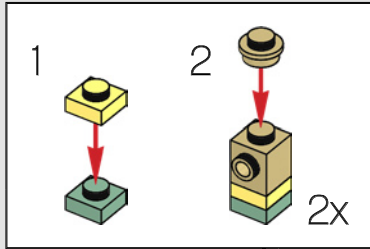

6

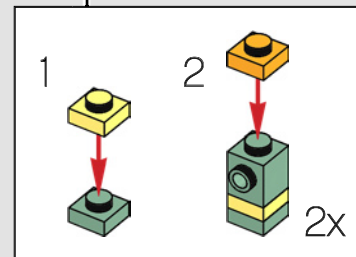
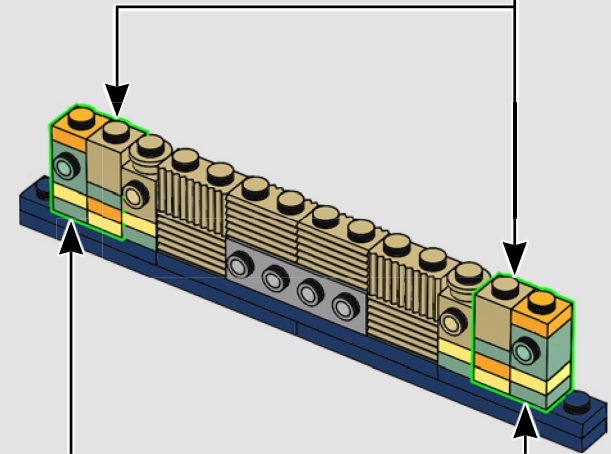
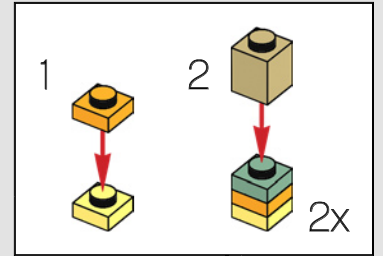

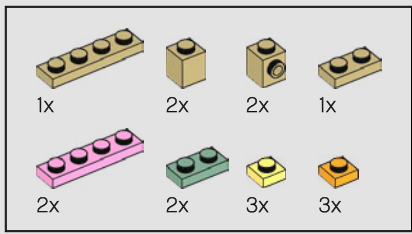

7

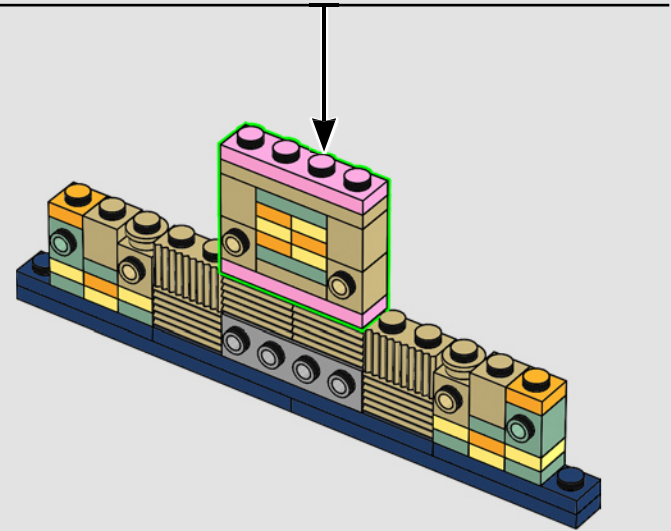
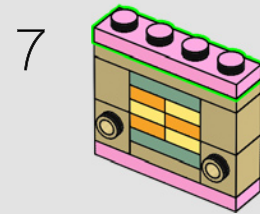
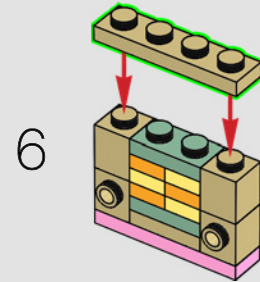
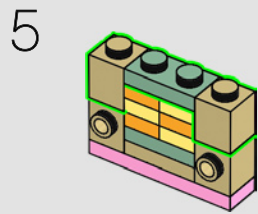
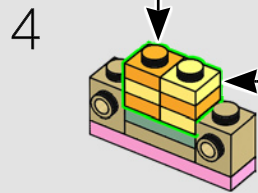
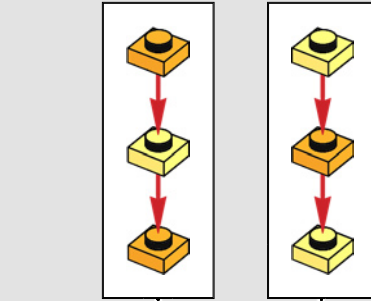
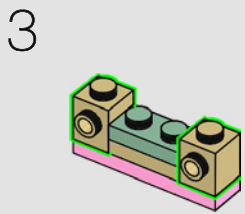
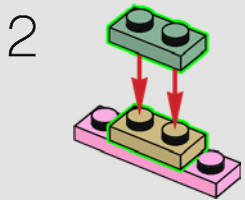
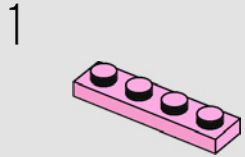



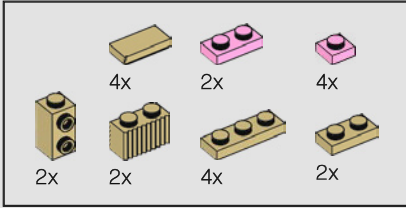
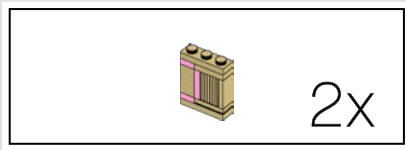

8

1

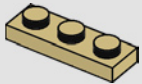

2

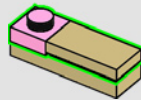

3

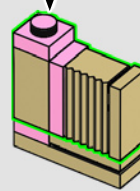

4

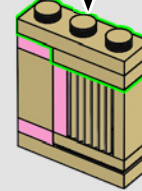

2x

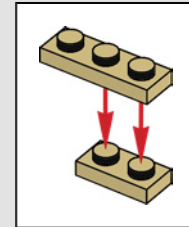
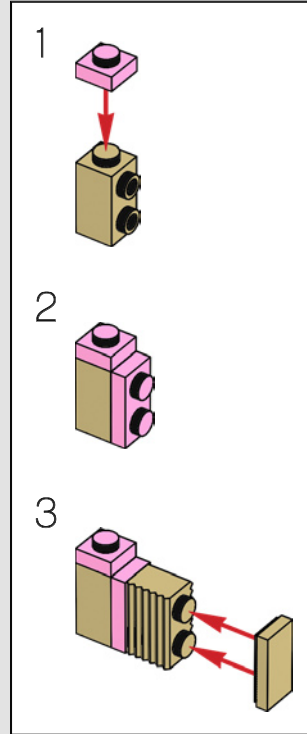

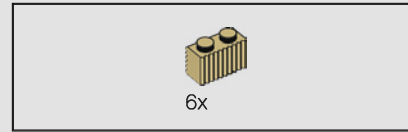
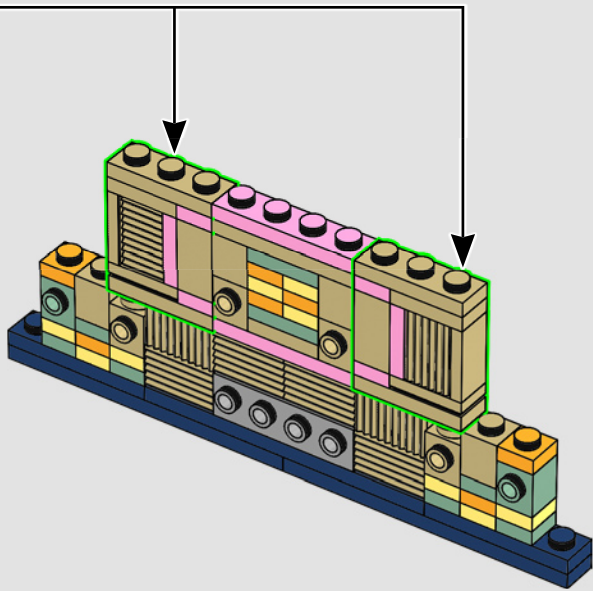

9

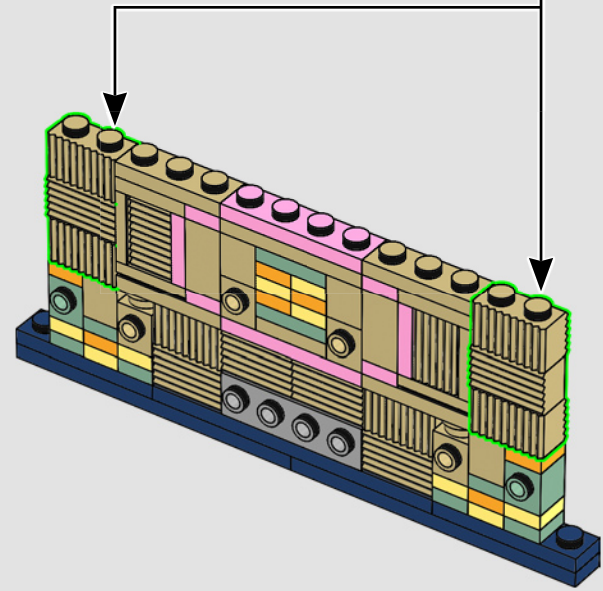
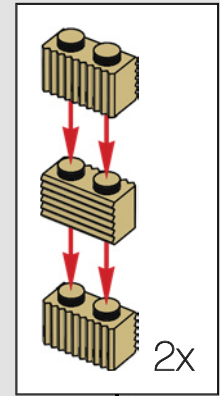

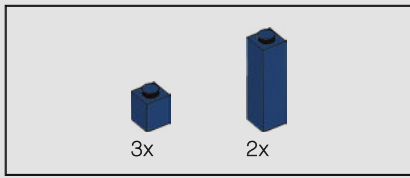

10

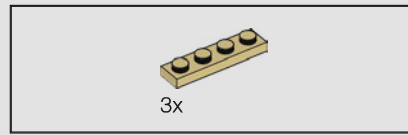
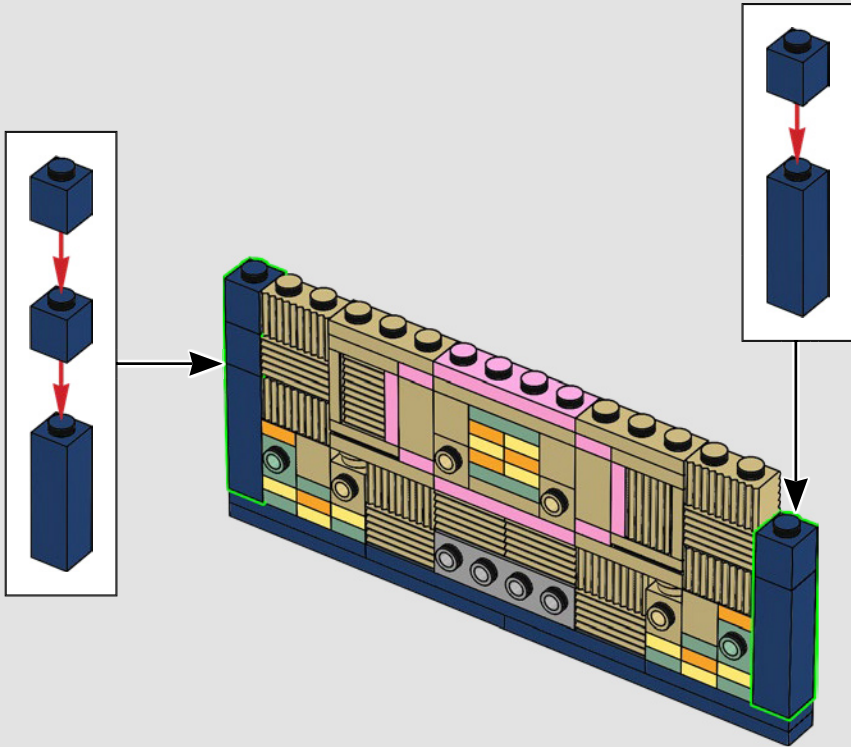

11

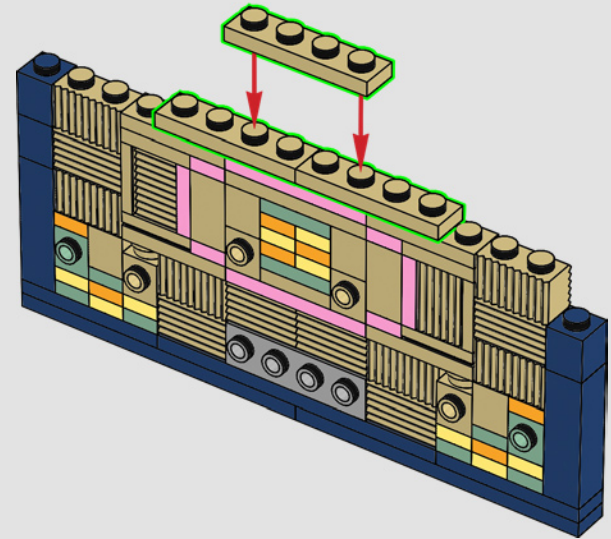



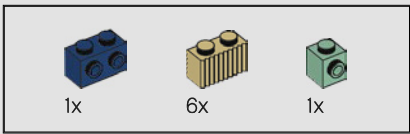

12

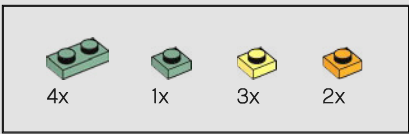
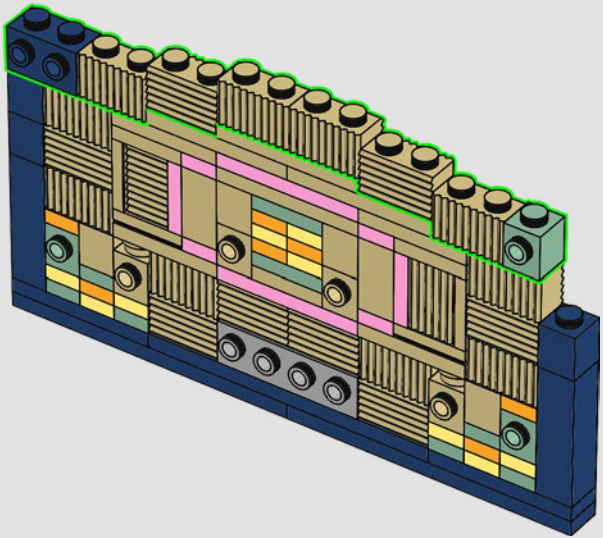

13

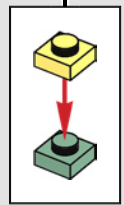
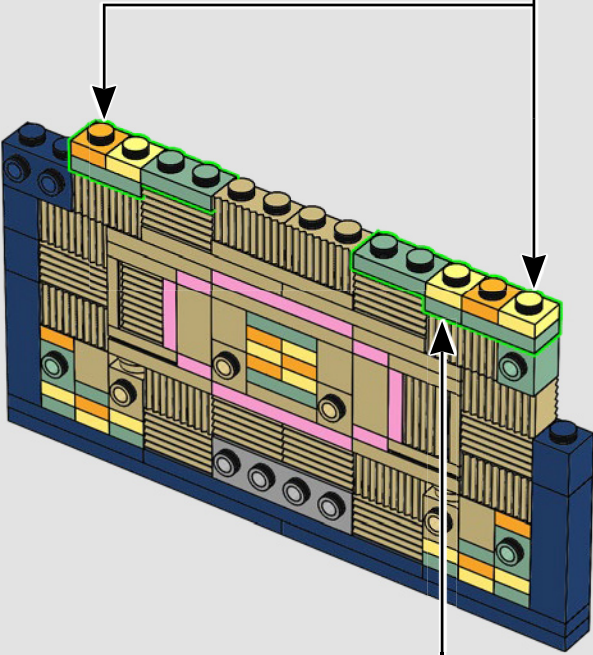
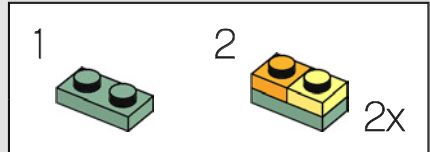

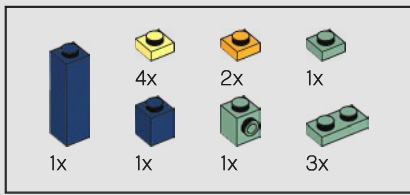

14

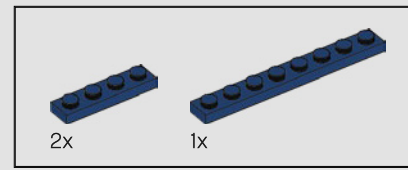
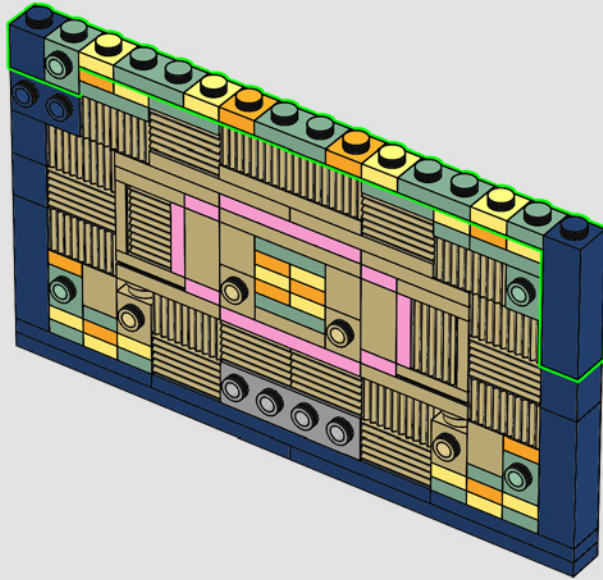

15

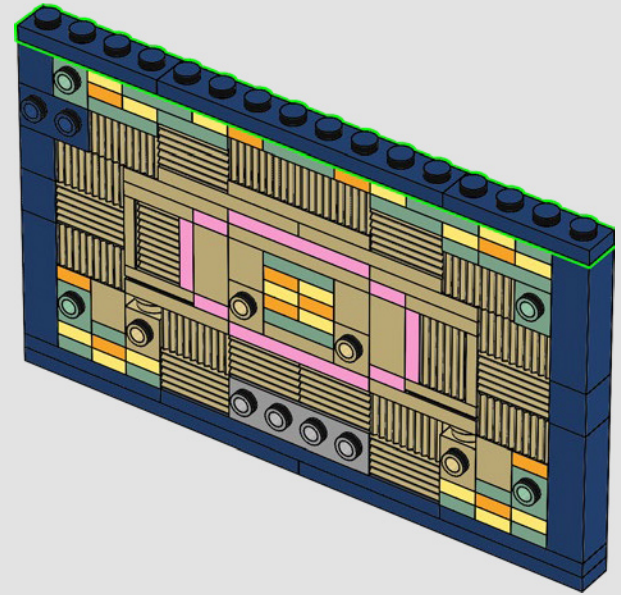

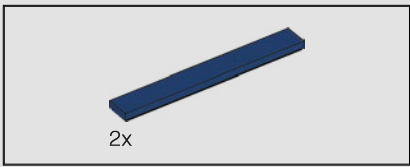

16

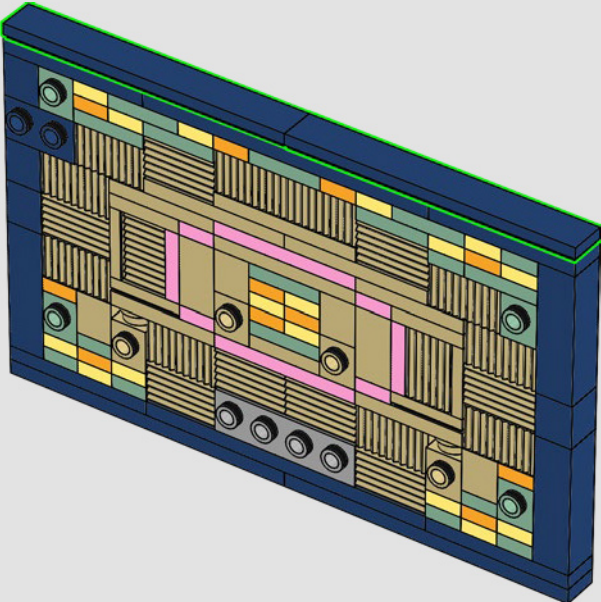



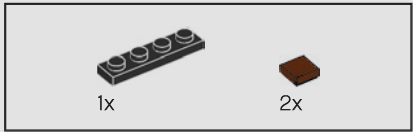
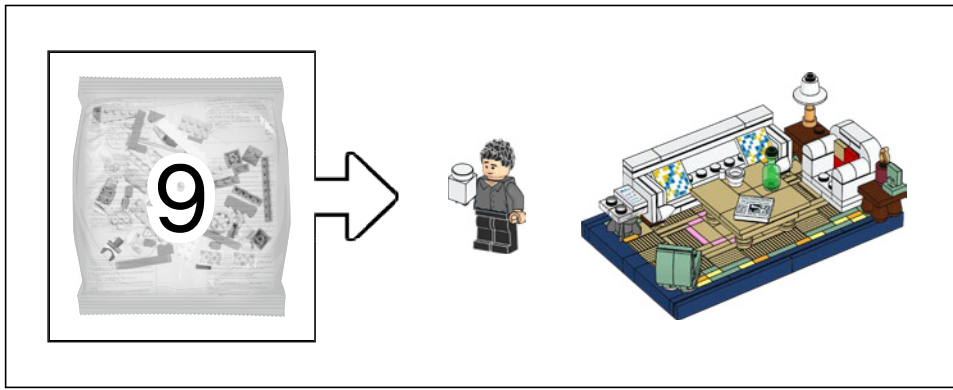

17

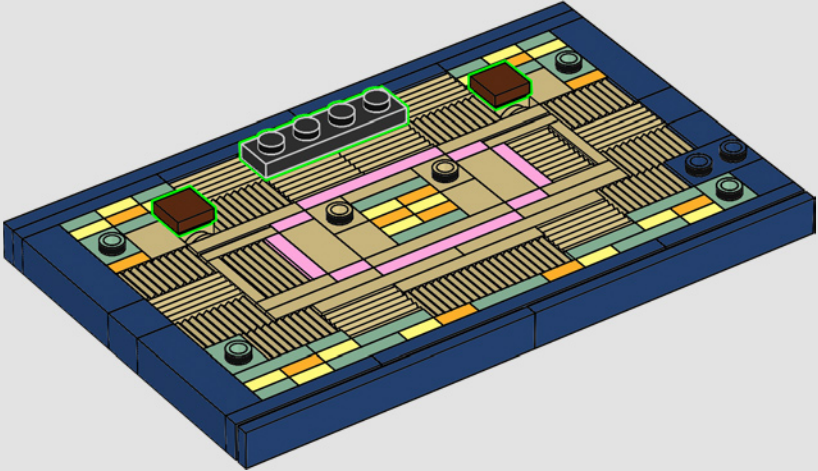
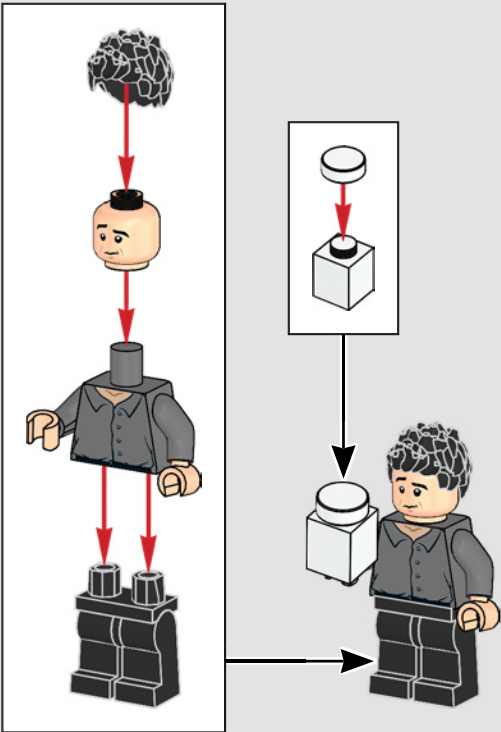

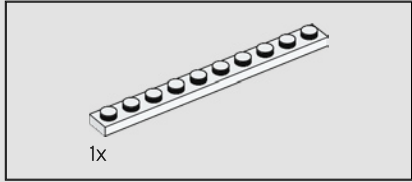
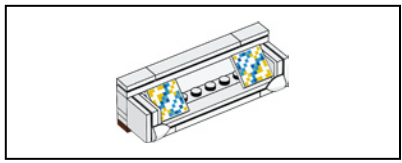

18

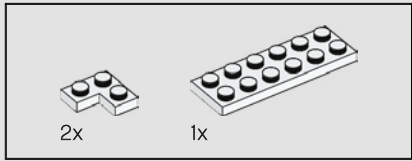
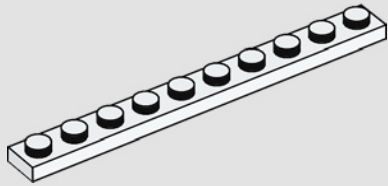

19

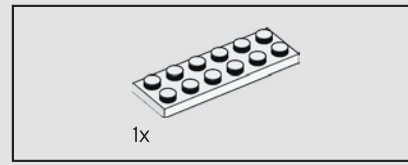
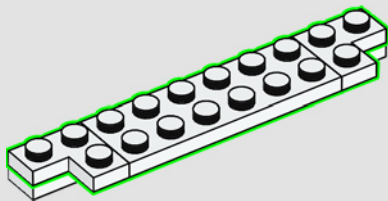

20

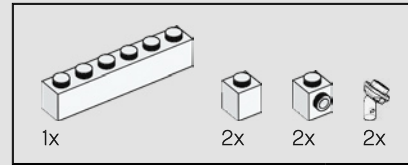
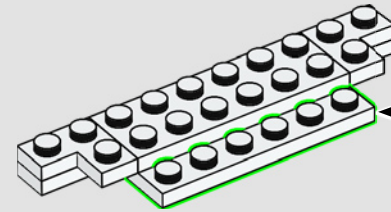
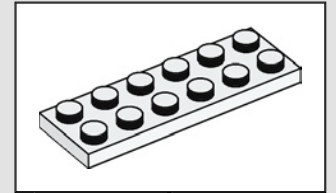

21

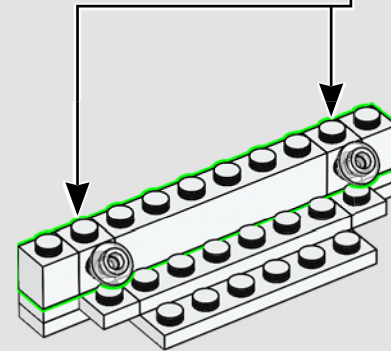
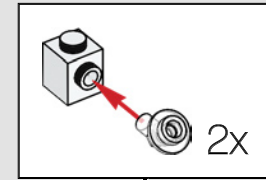

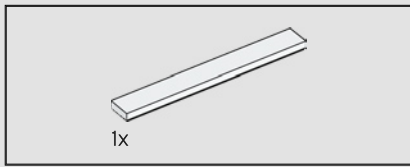

22

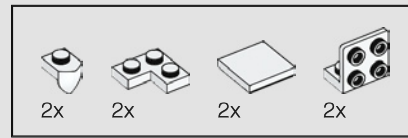
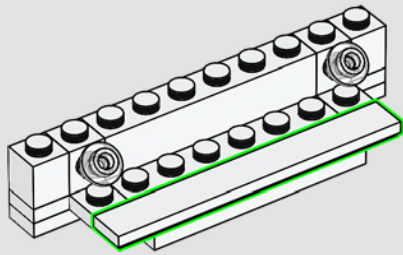

23

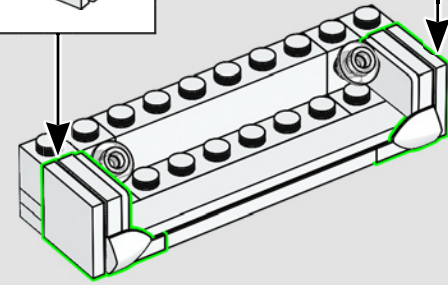
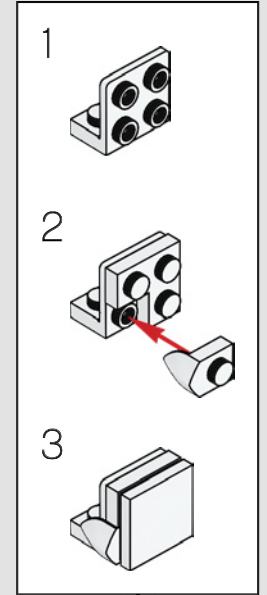
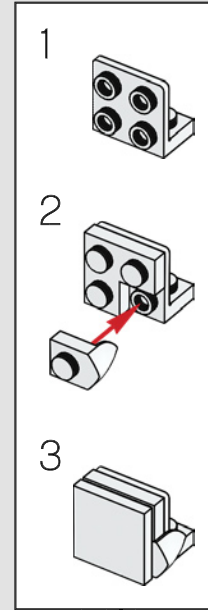



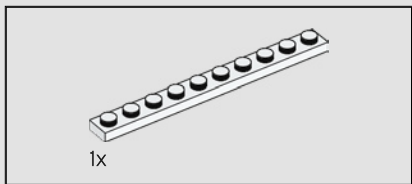

24

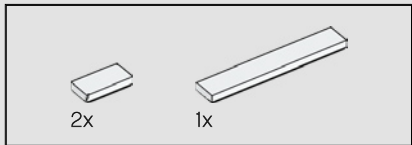
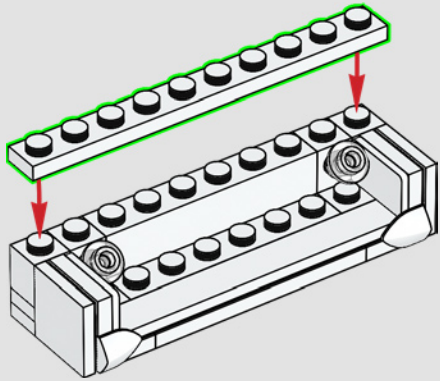

25

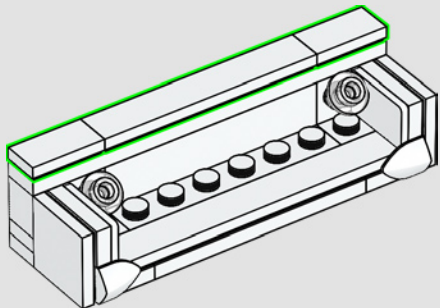

26

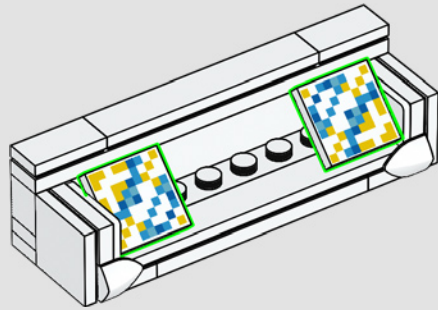

27

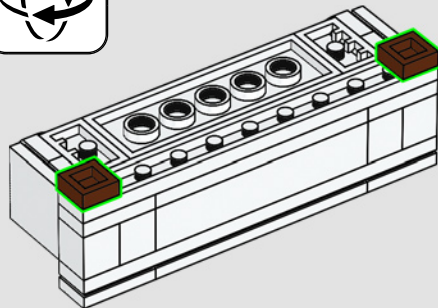

28

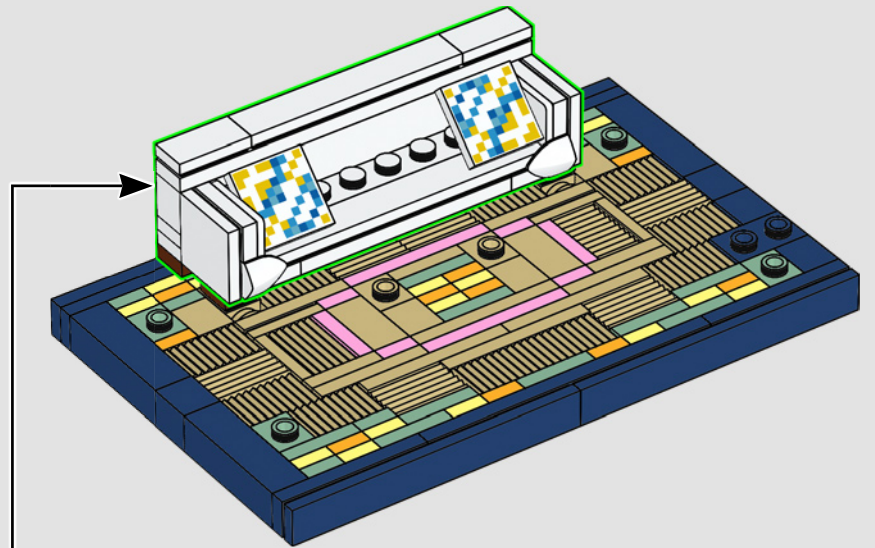

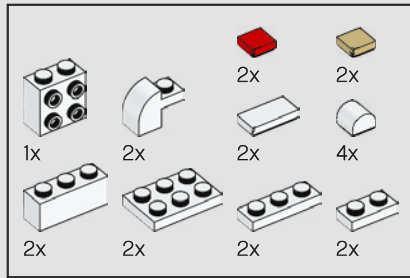
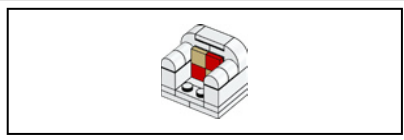

29

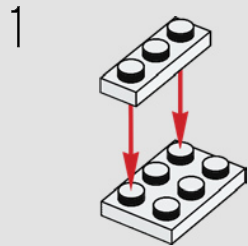

2

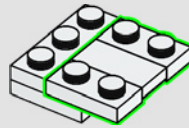

3

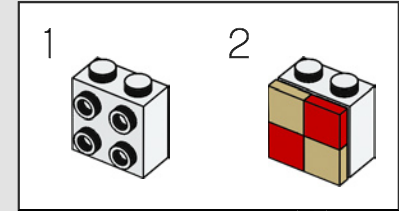
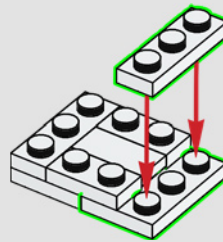

4

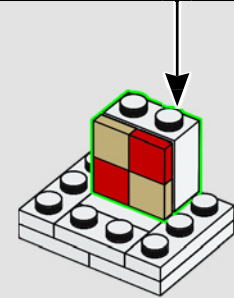

5

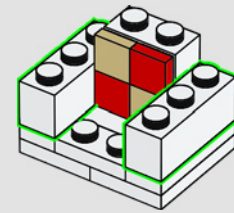

6

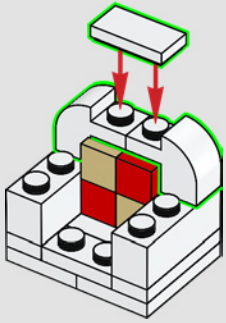

7

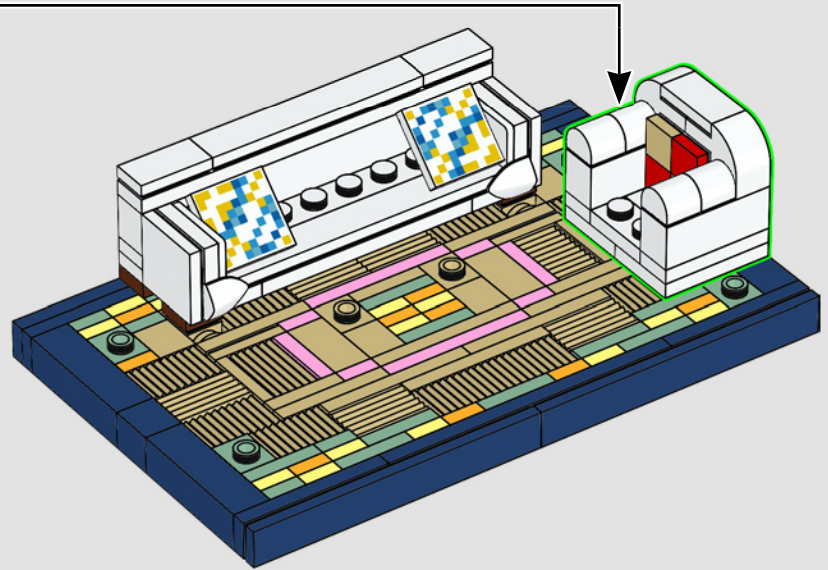
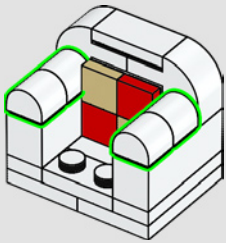



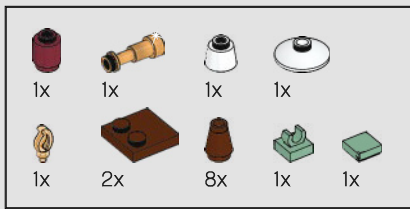

30

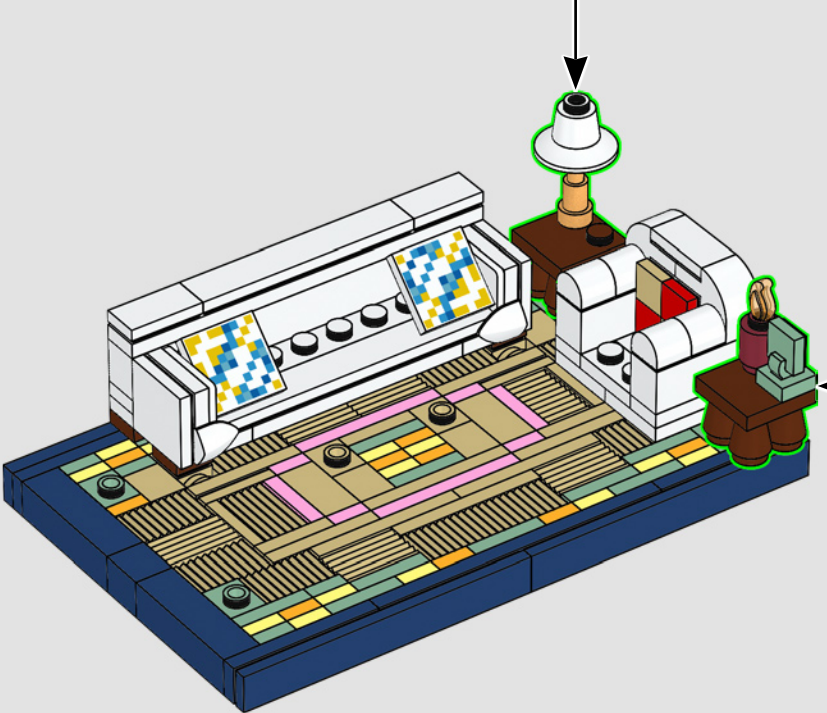
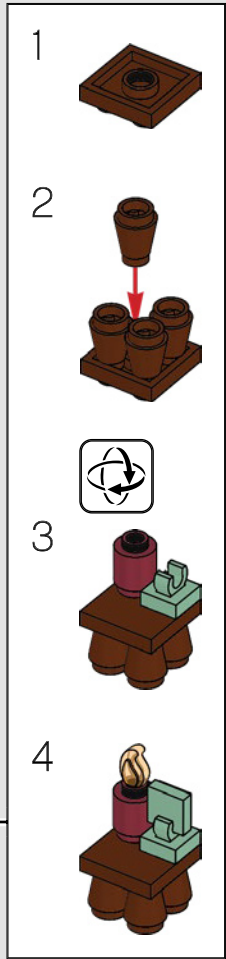
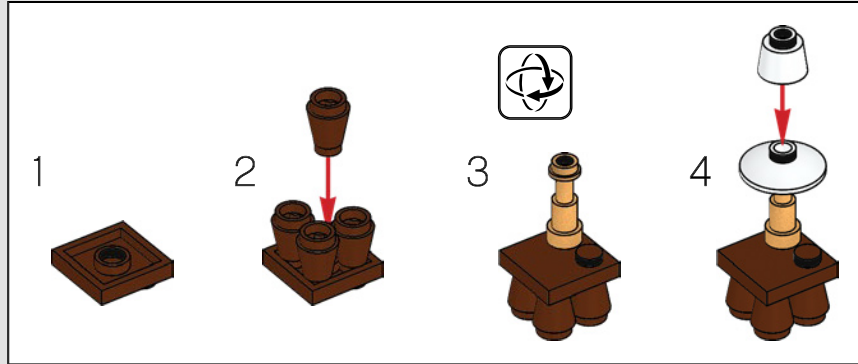

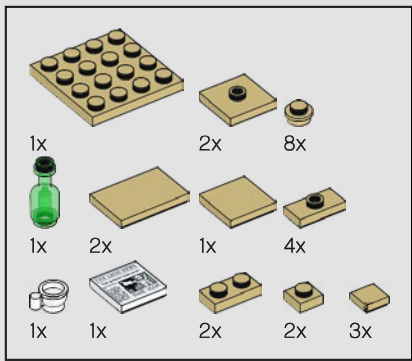

31

1

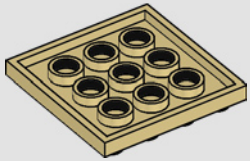

2

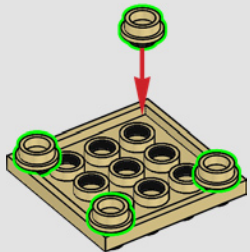

3

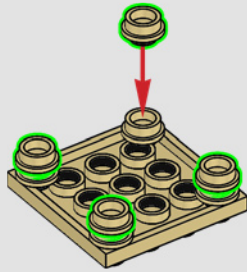

4

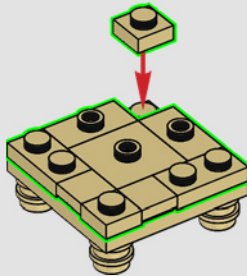

5

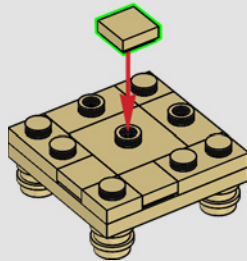

6

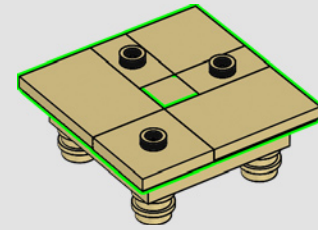

7

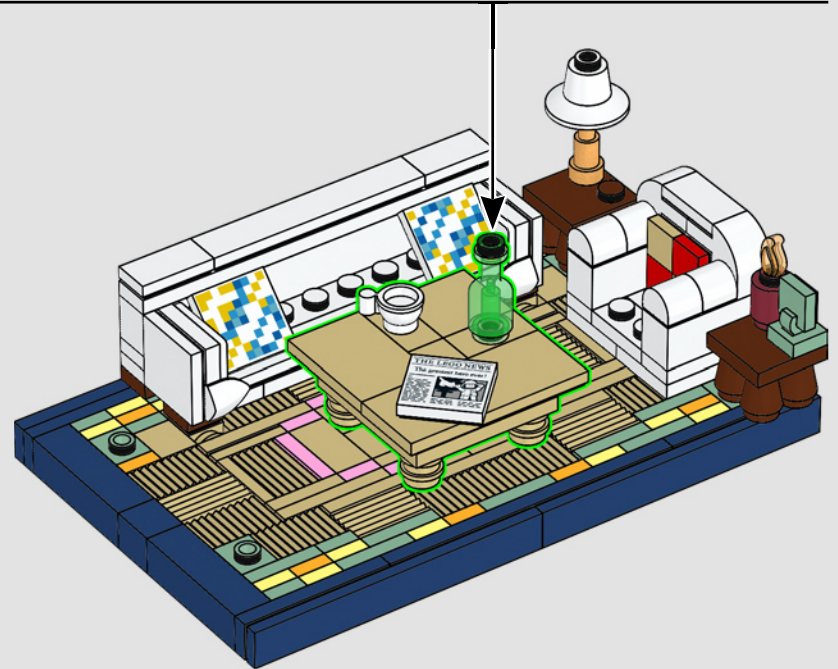
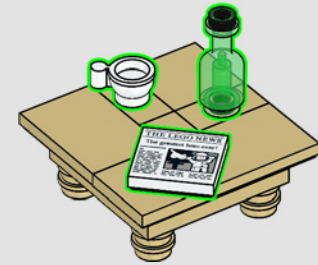

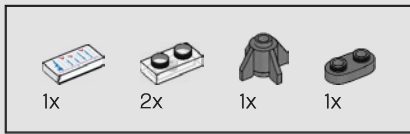

32

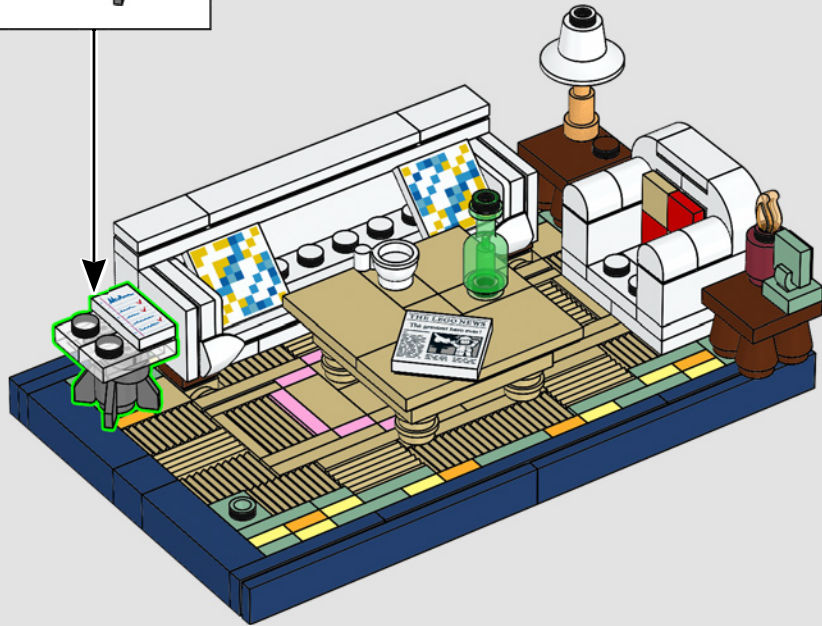
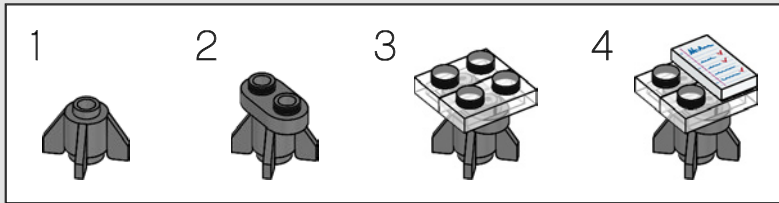



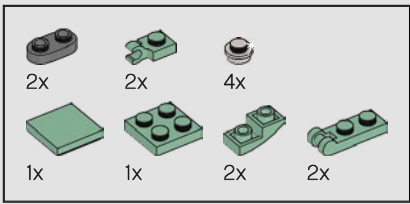

33

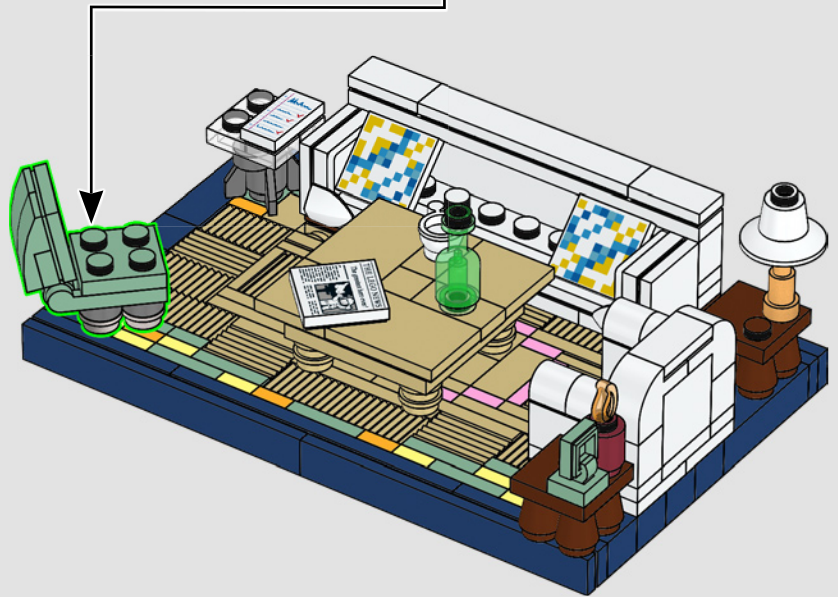
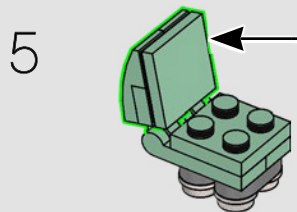
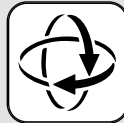
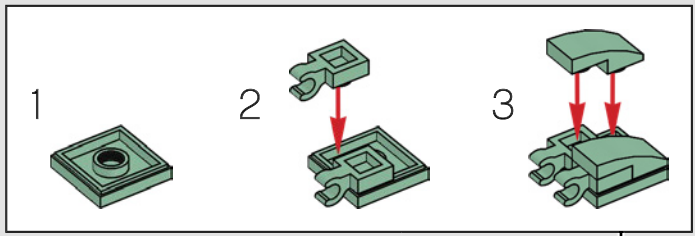
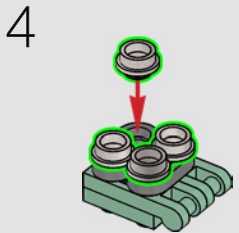
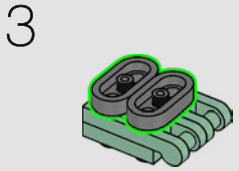
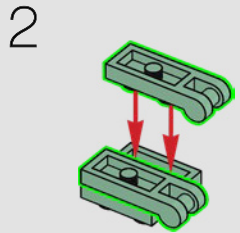
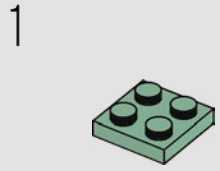

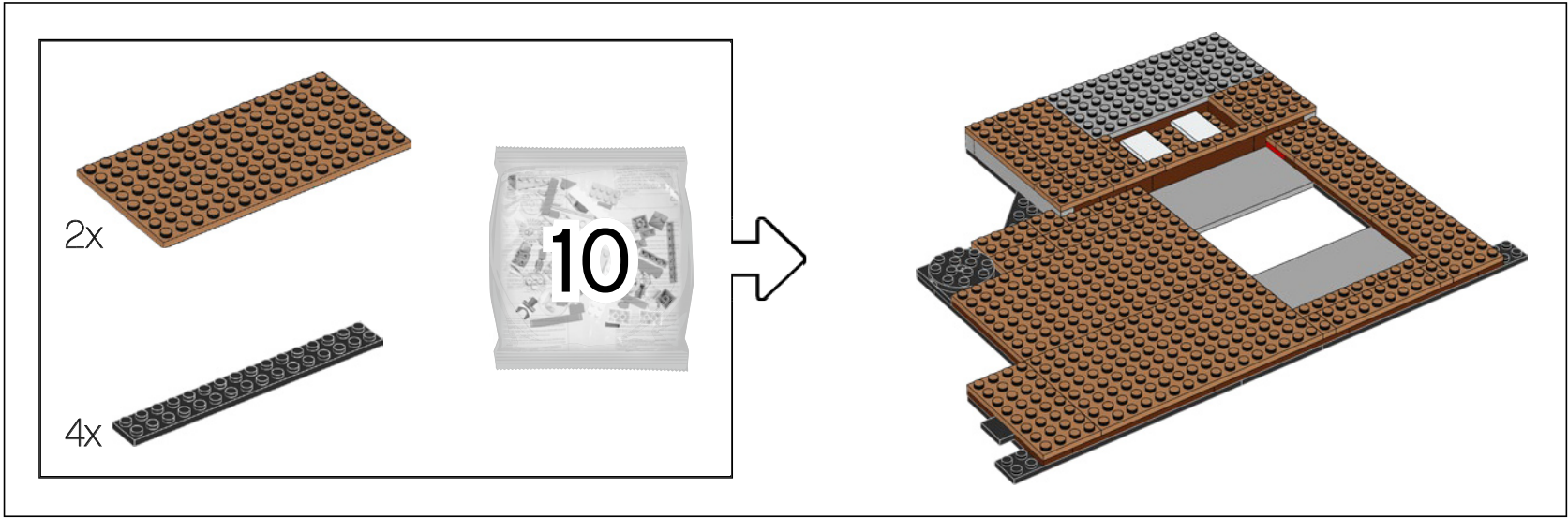

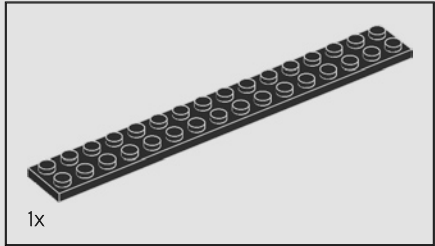
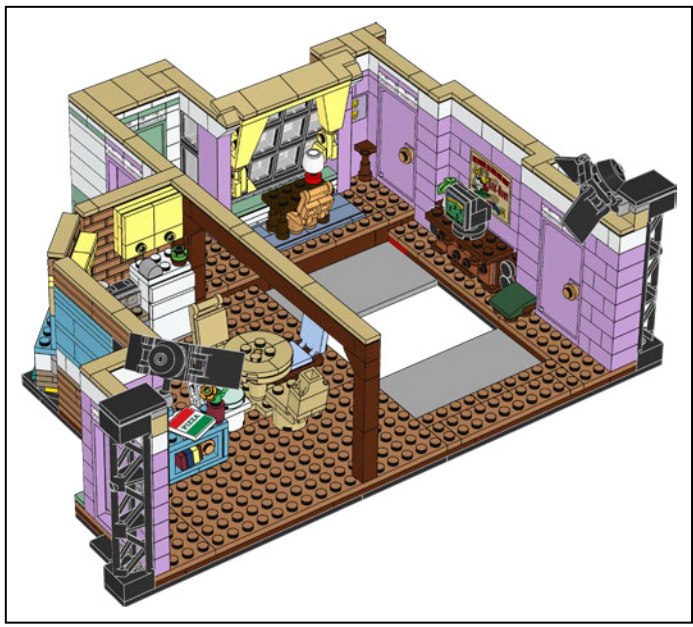

1

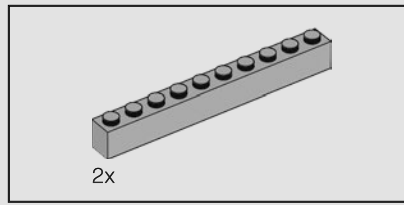
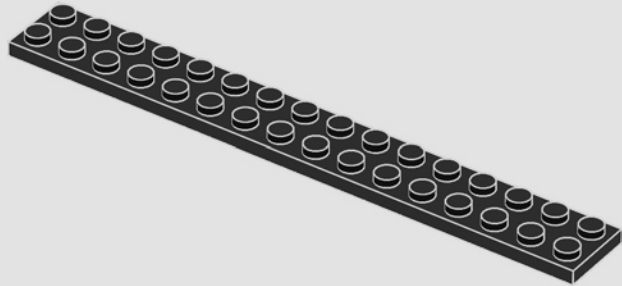

2

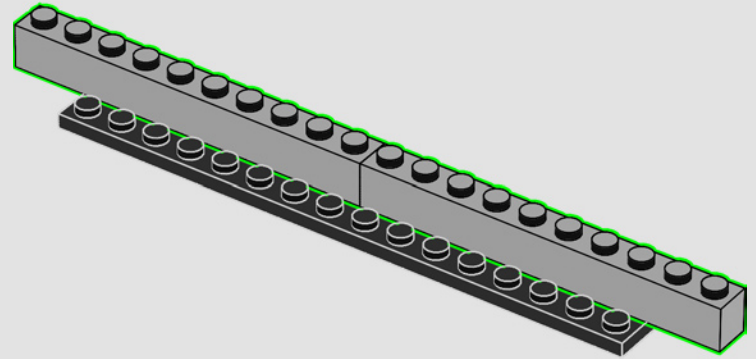



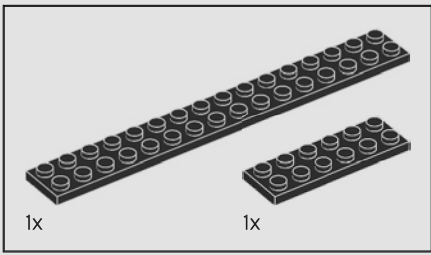

3

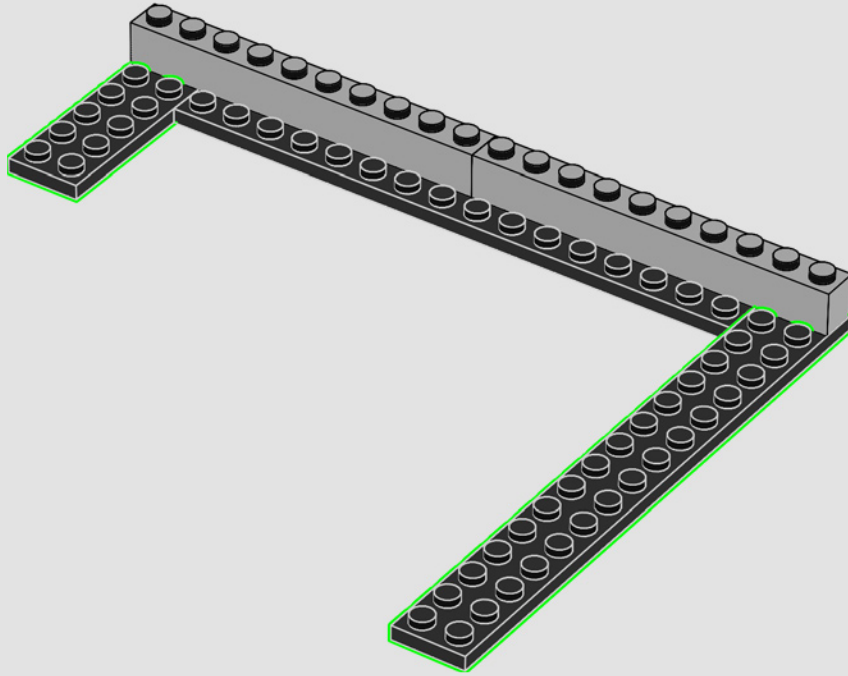

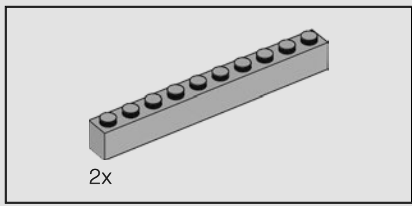

4

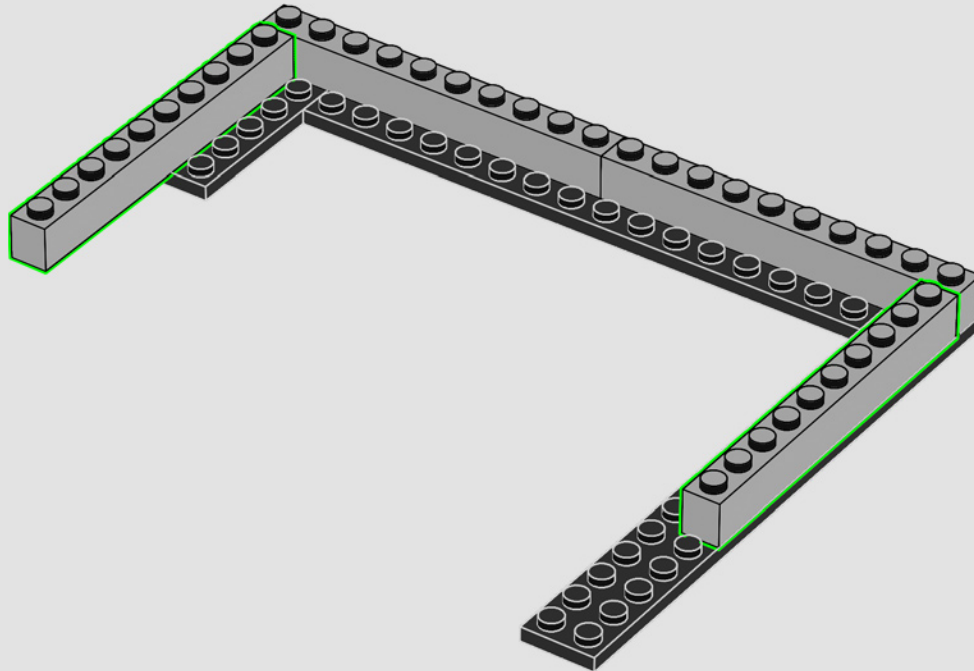

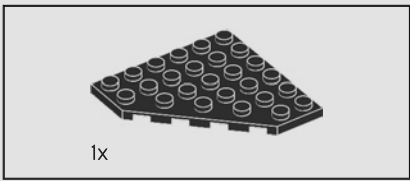

5

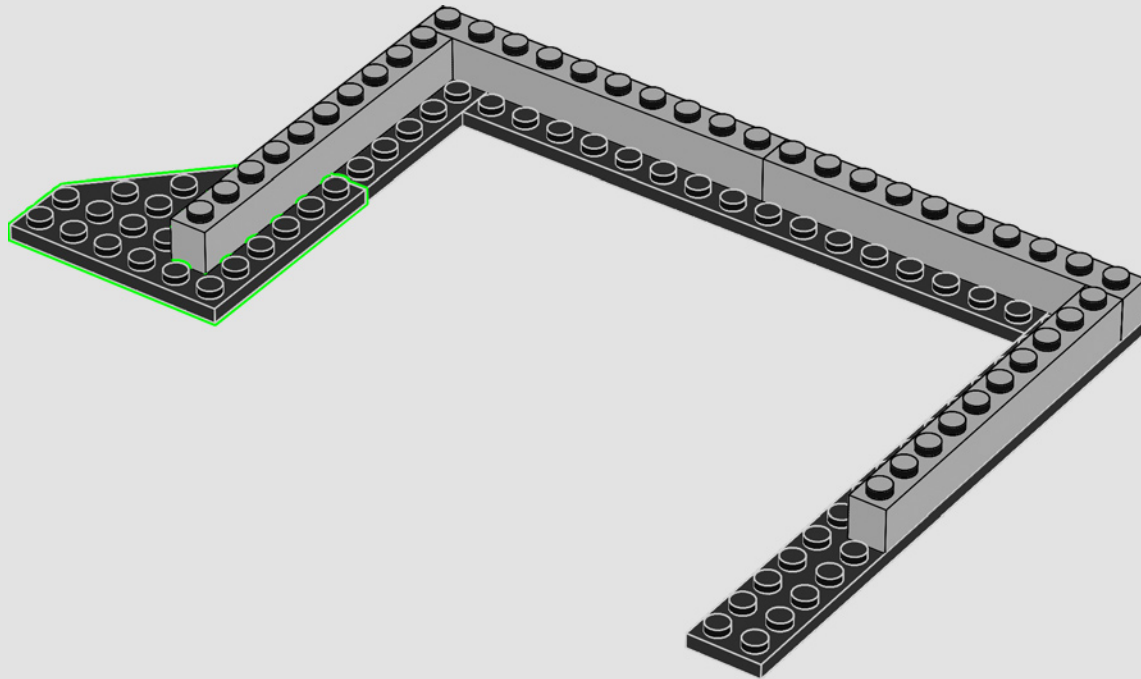



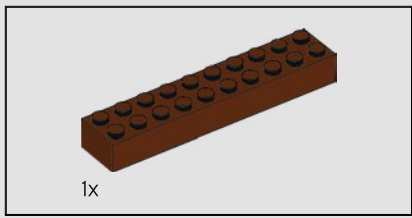

6

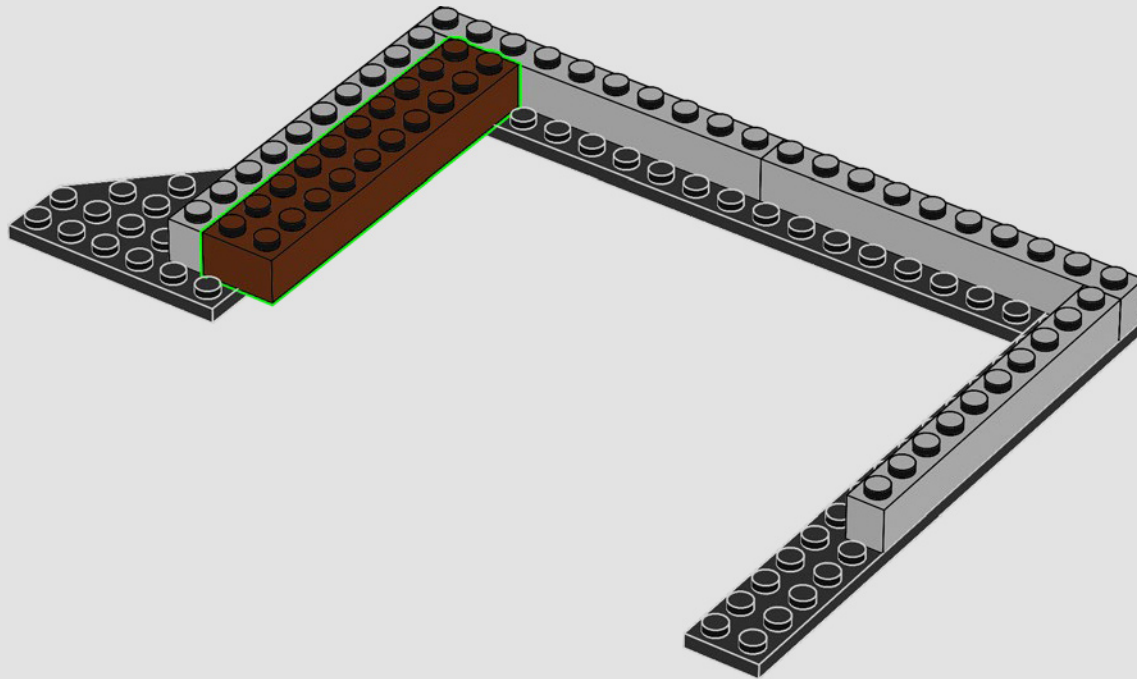

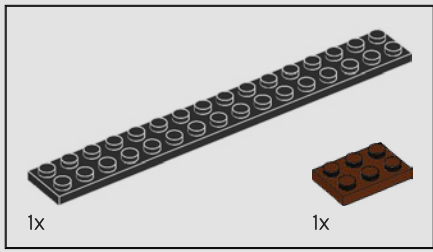

7

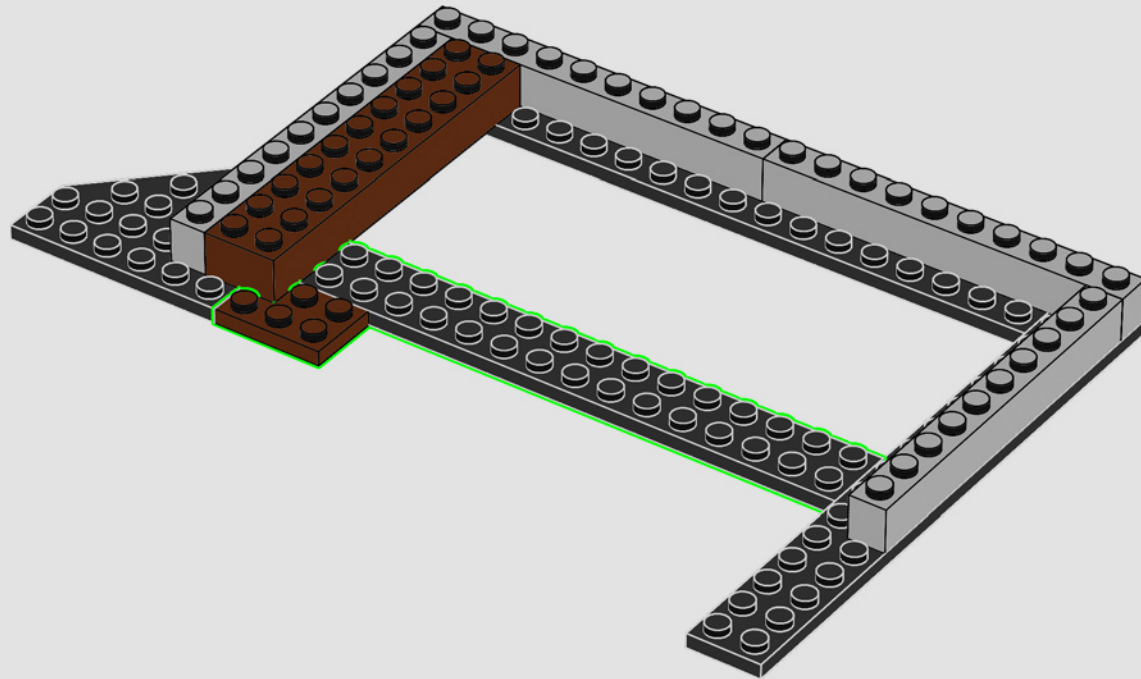

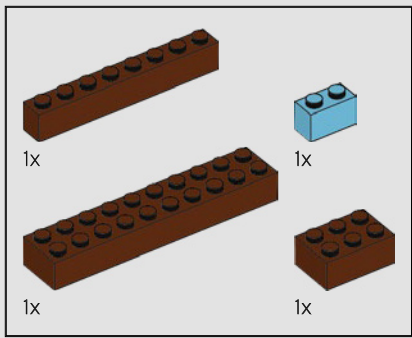

8

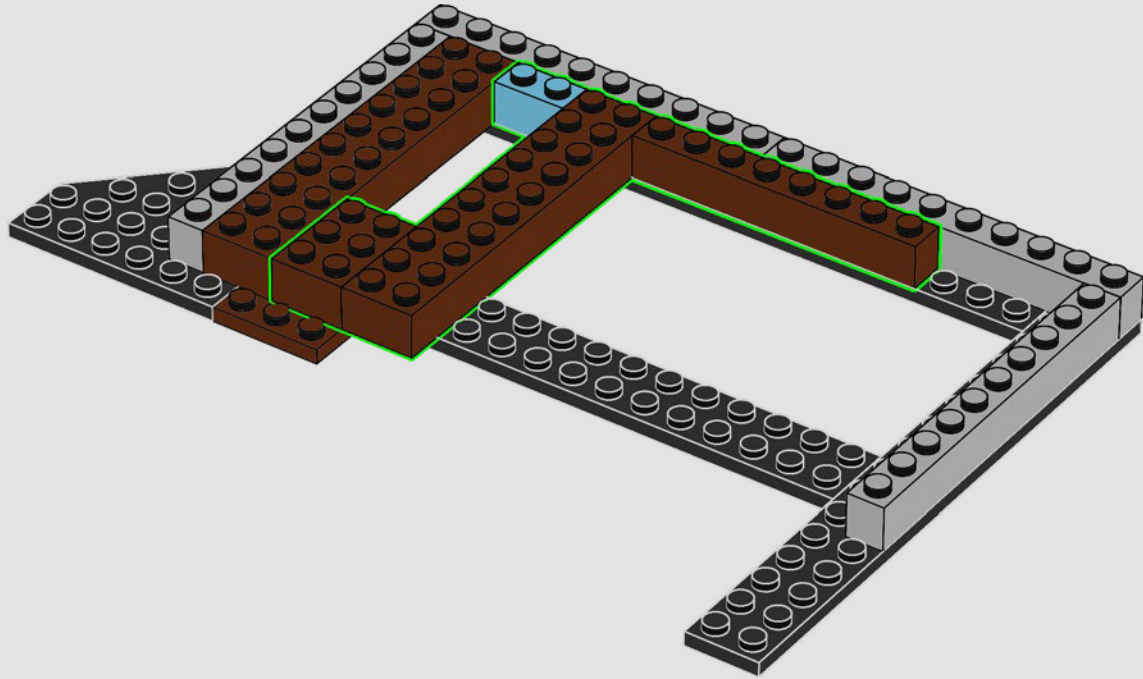



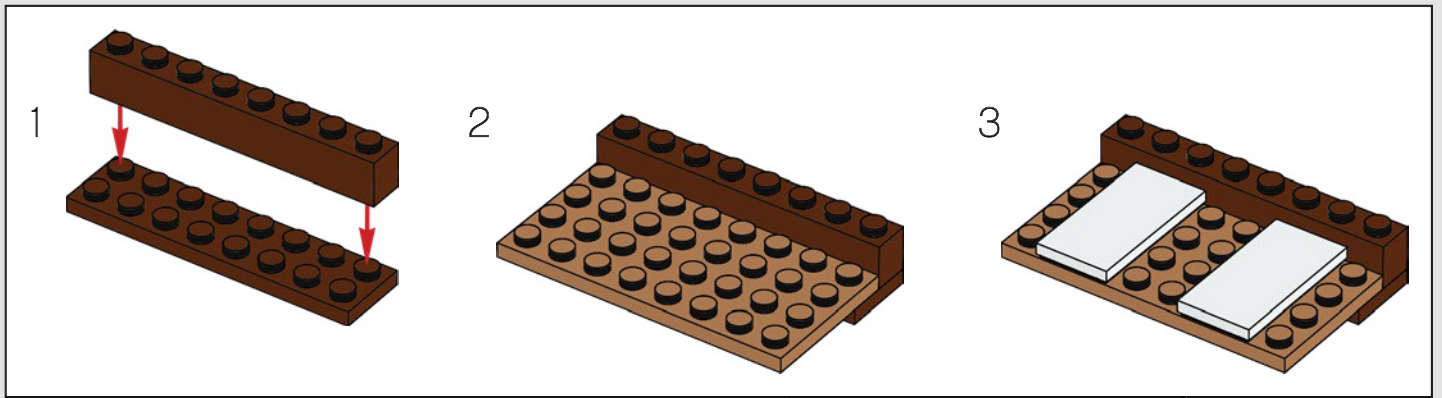
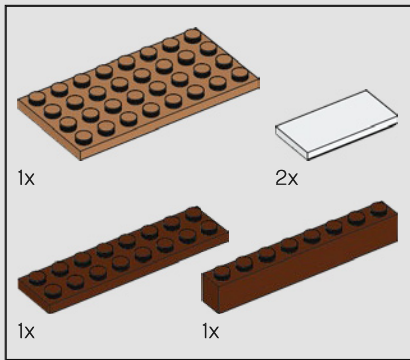

9

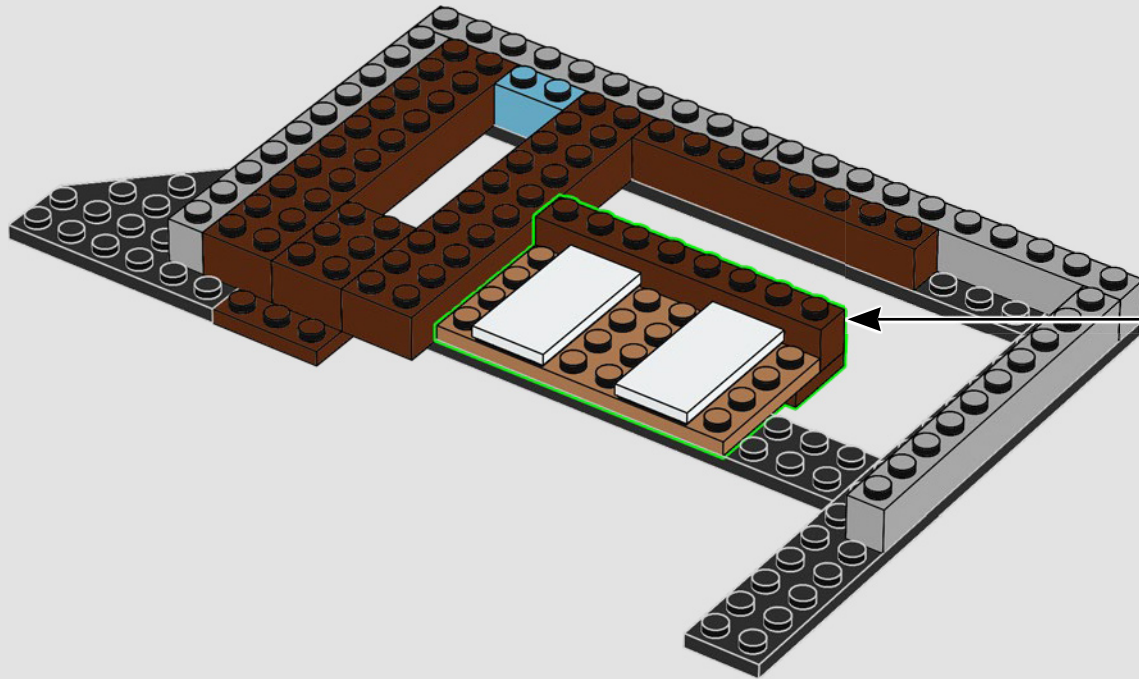

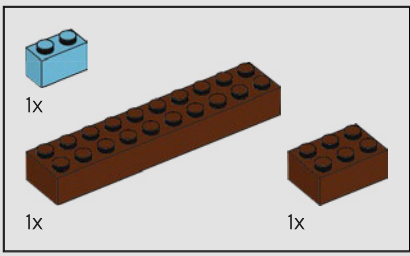

10

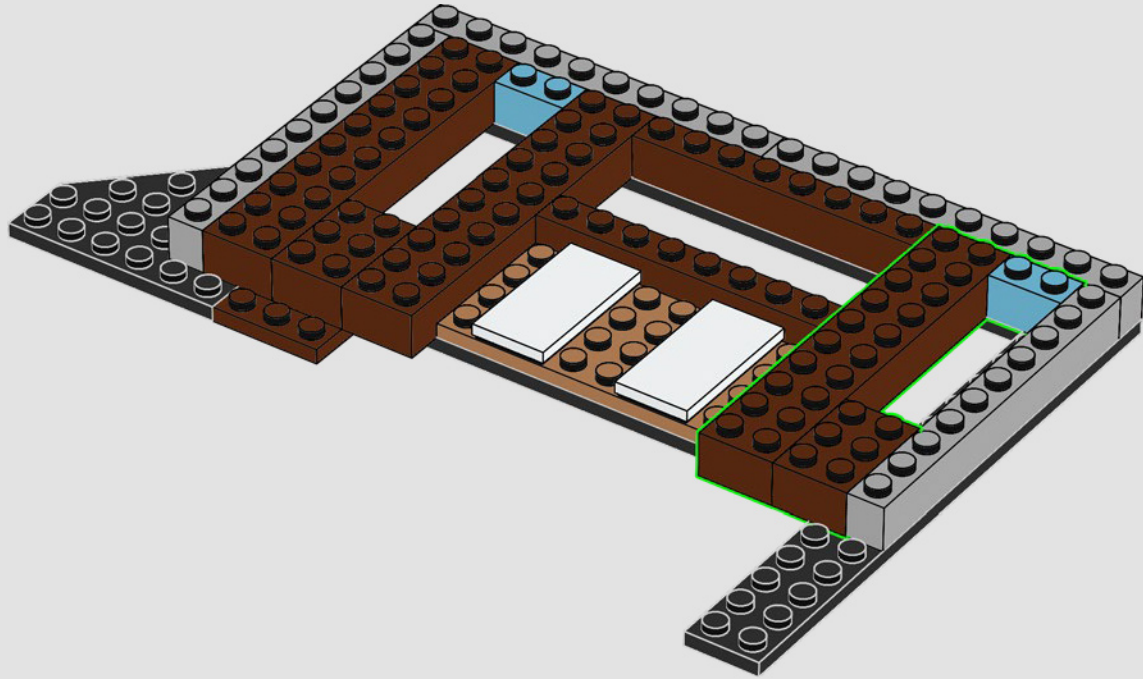

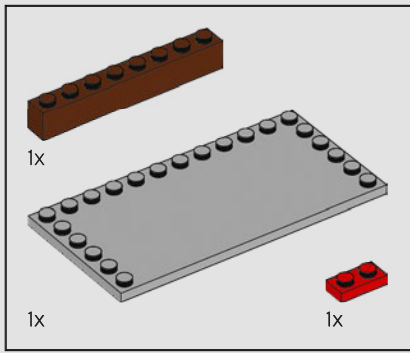

11

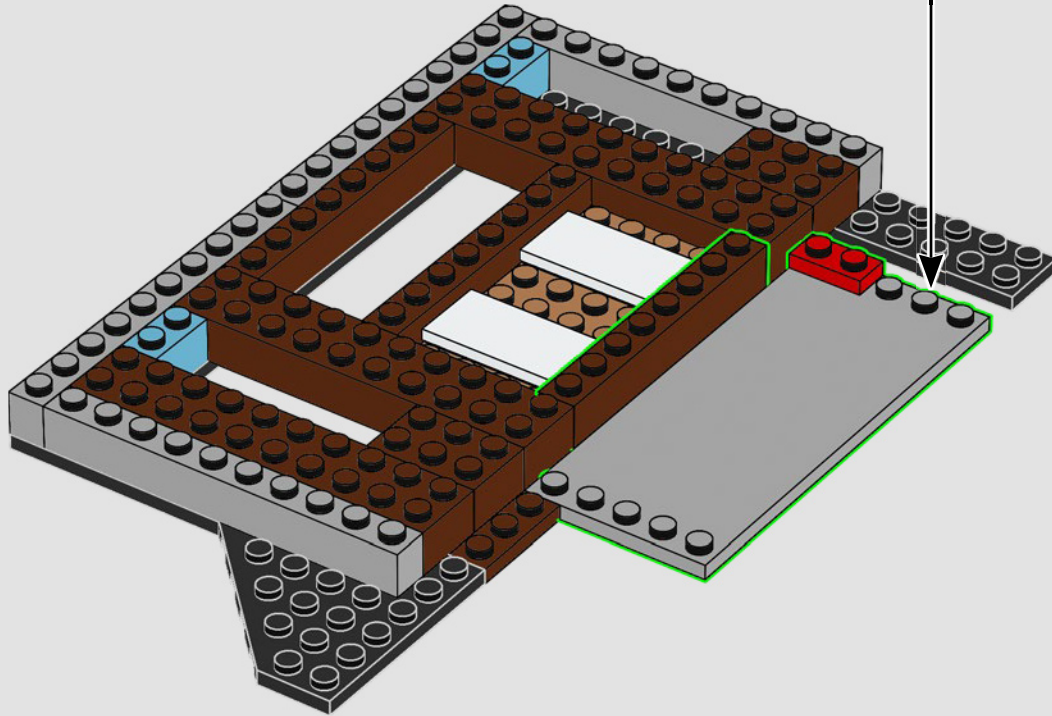
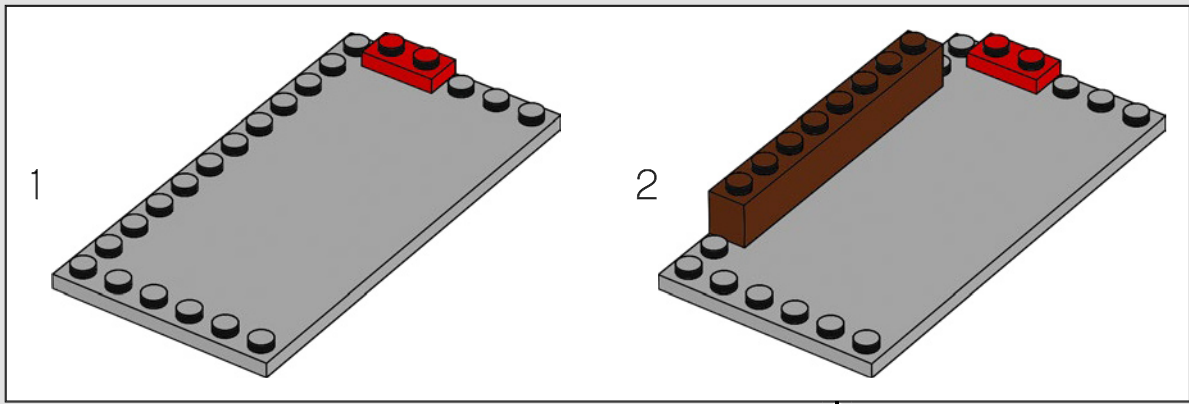



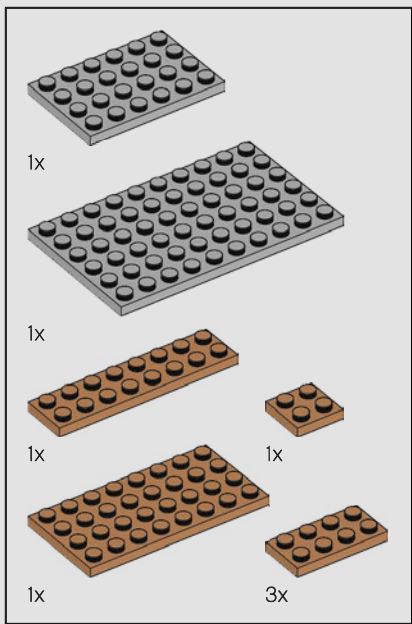

12

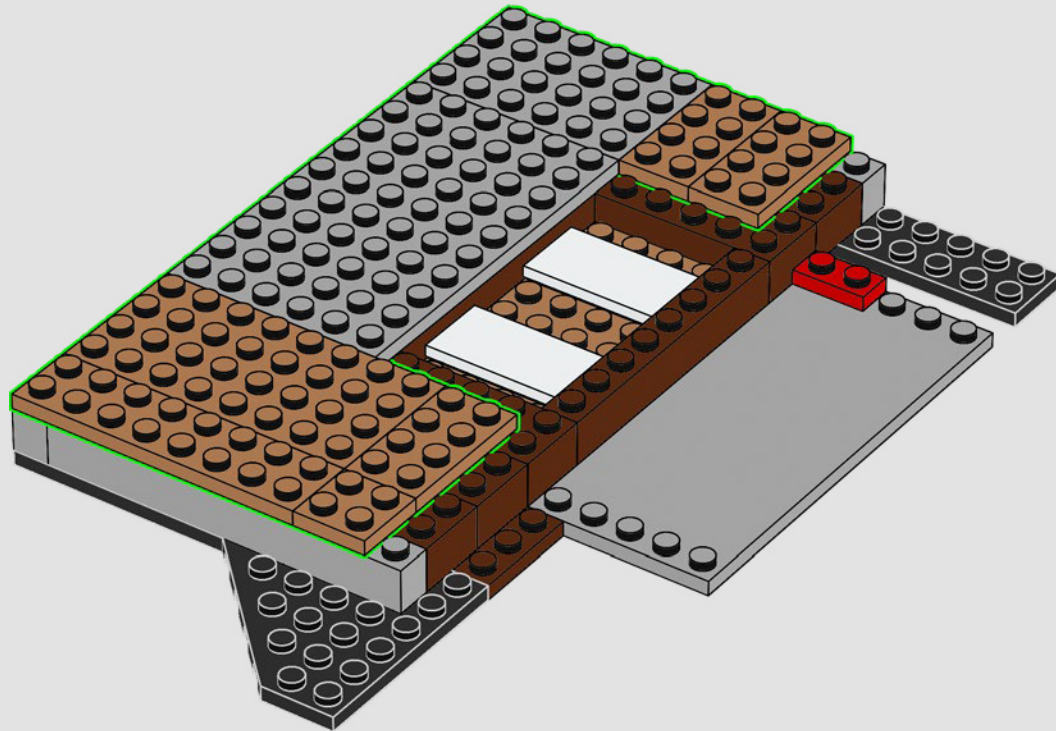

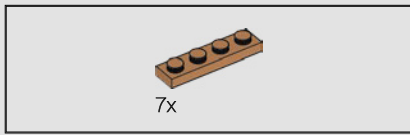

13

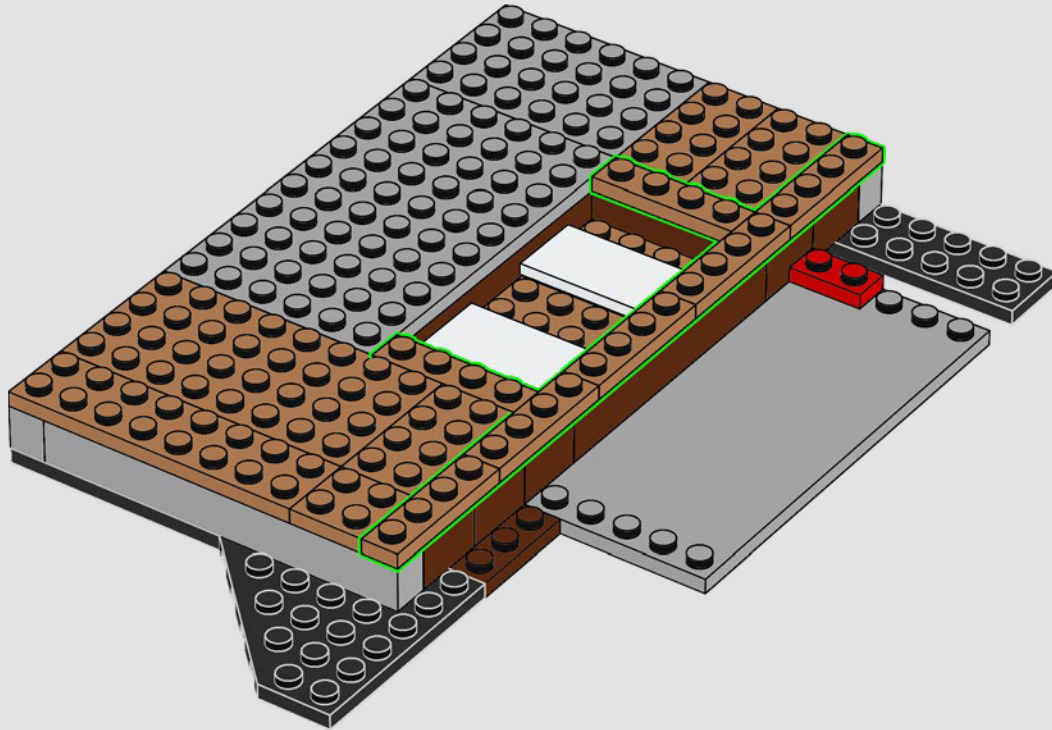

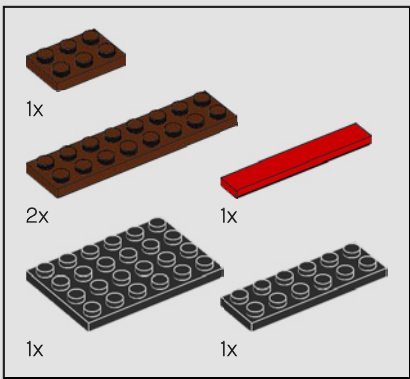

14

1

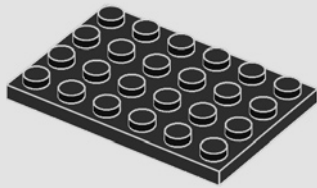

2

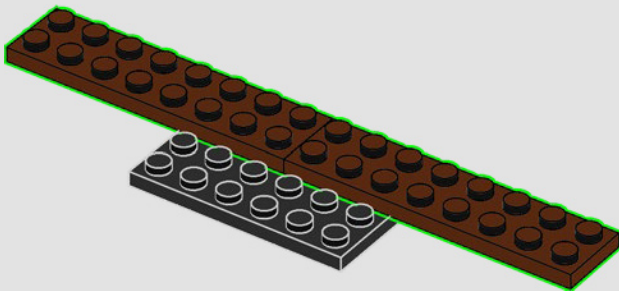

3

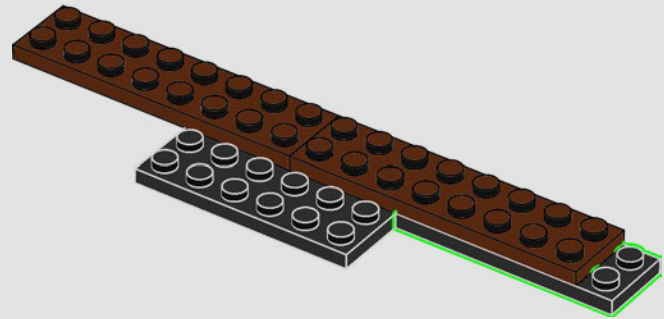

4

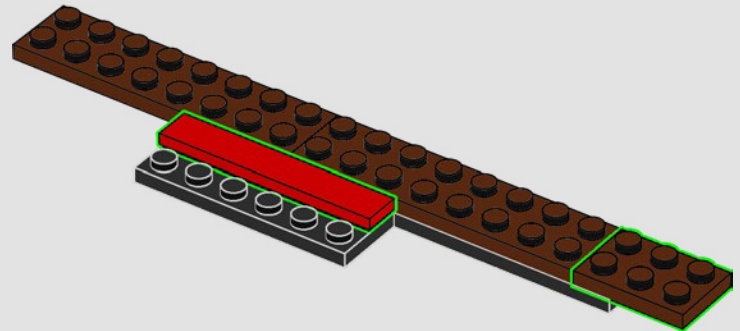



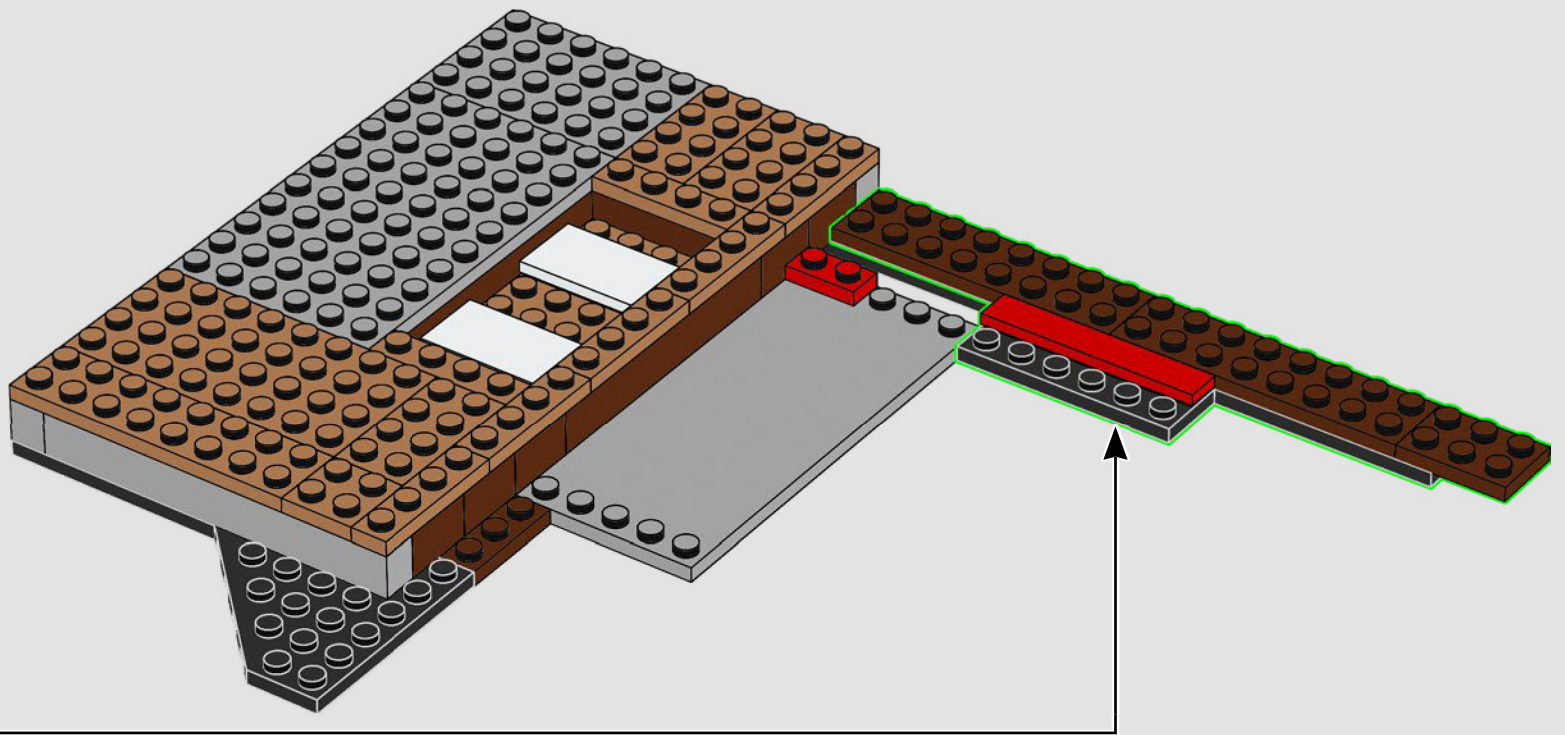

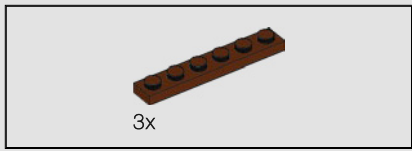

15

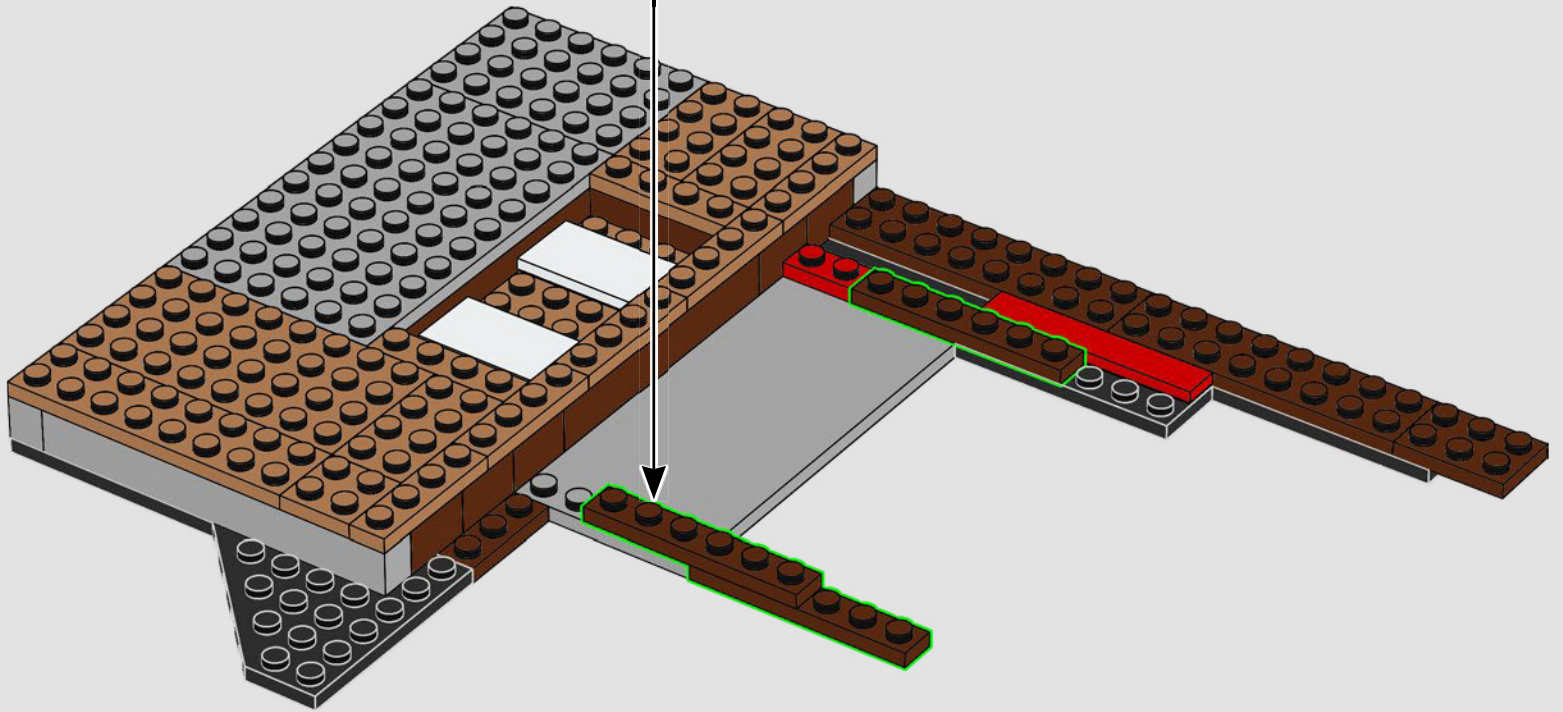
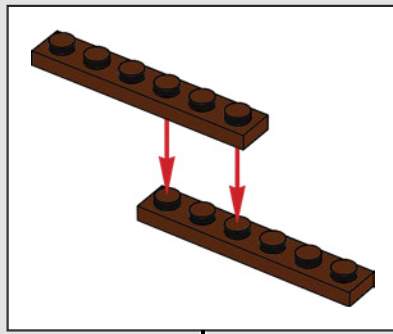

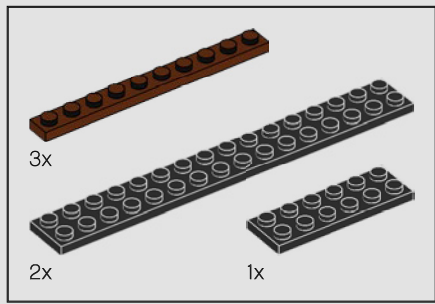

16

1

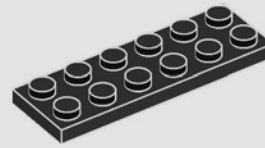

2

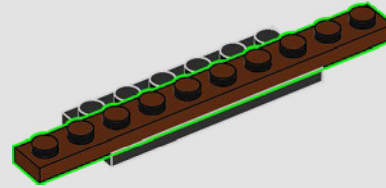

3

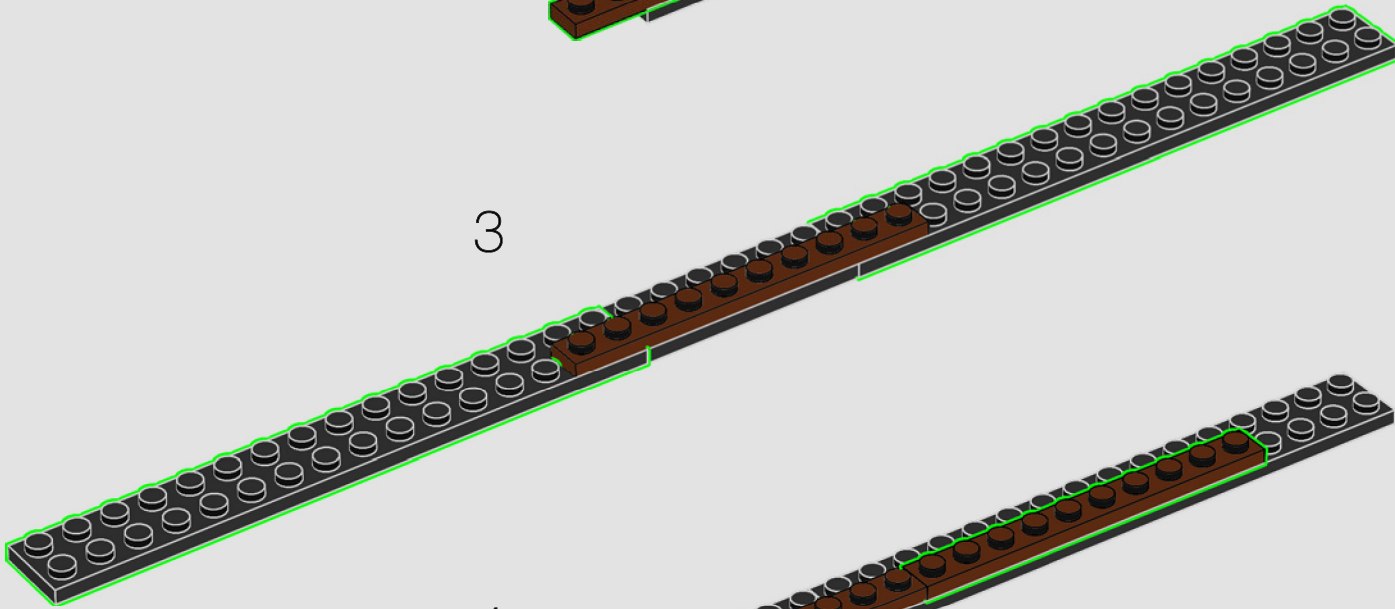

4

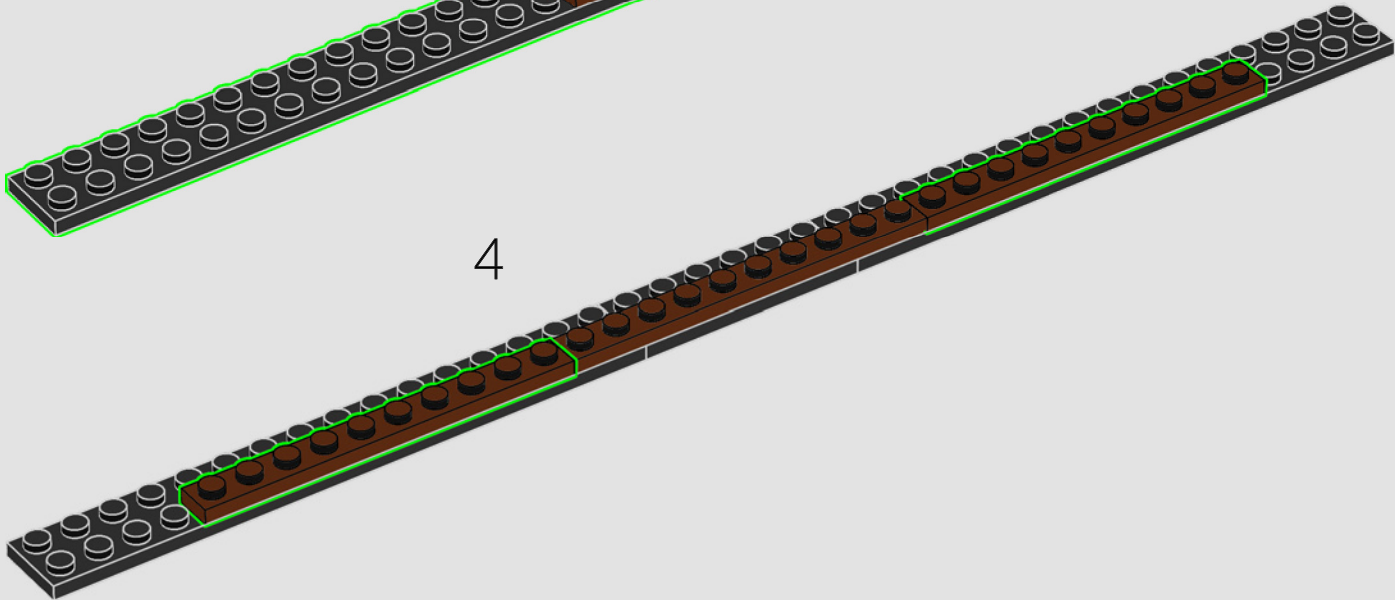



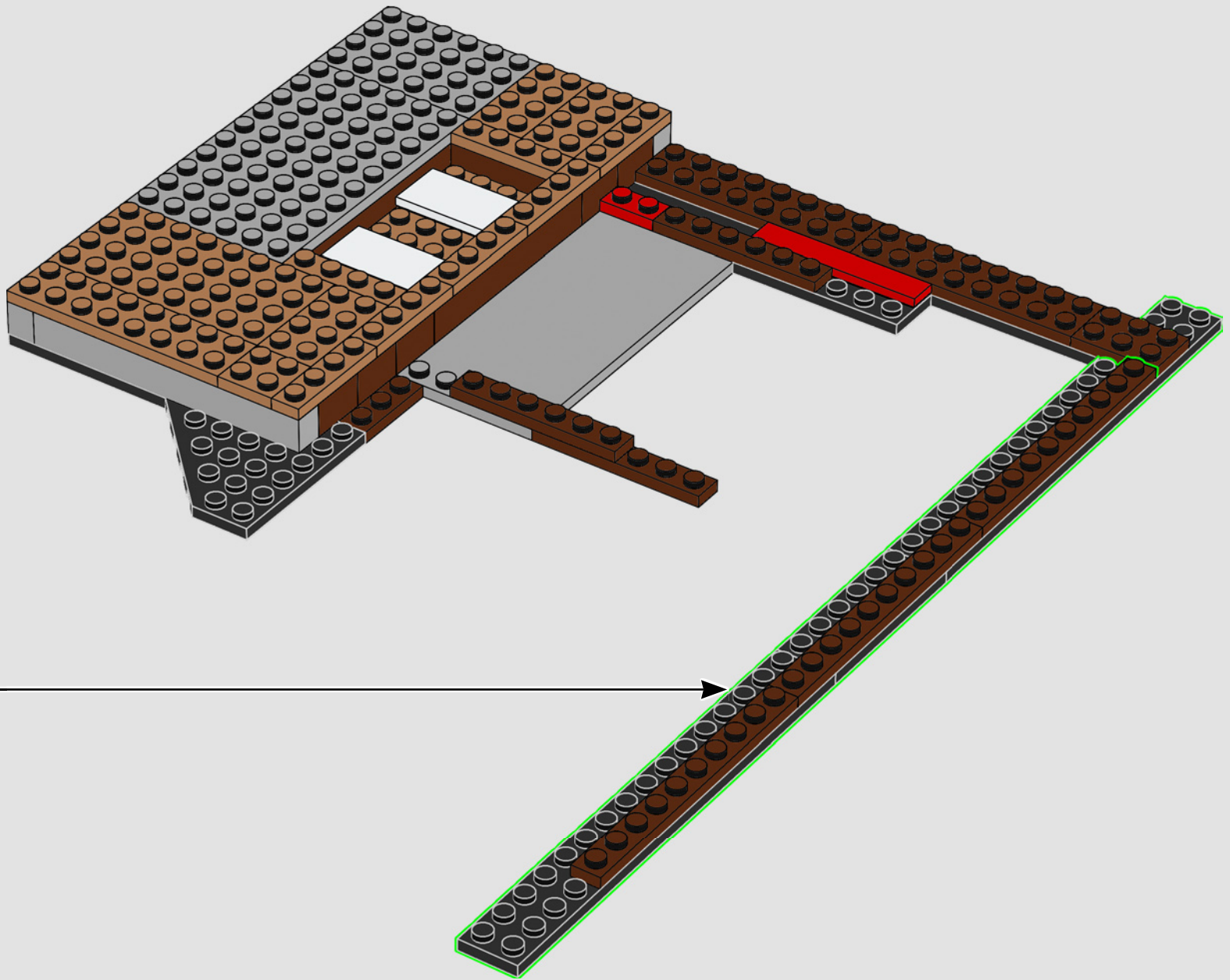

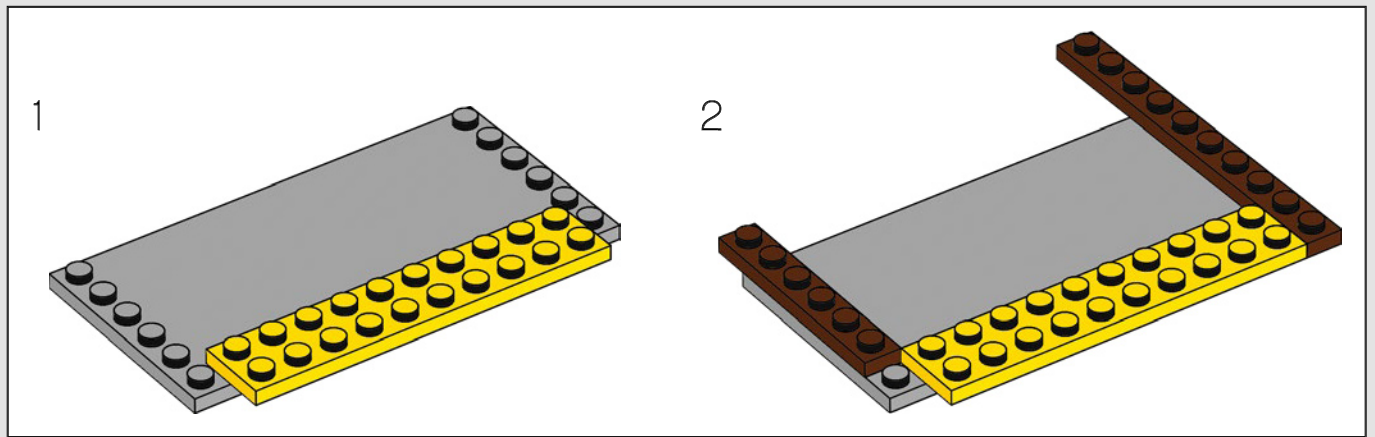
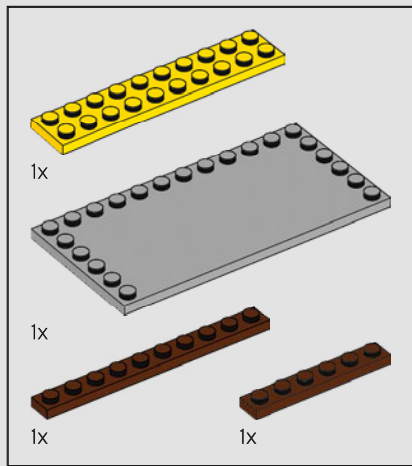

17

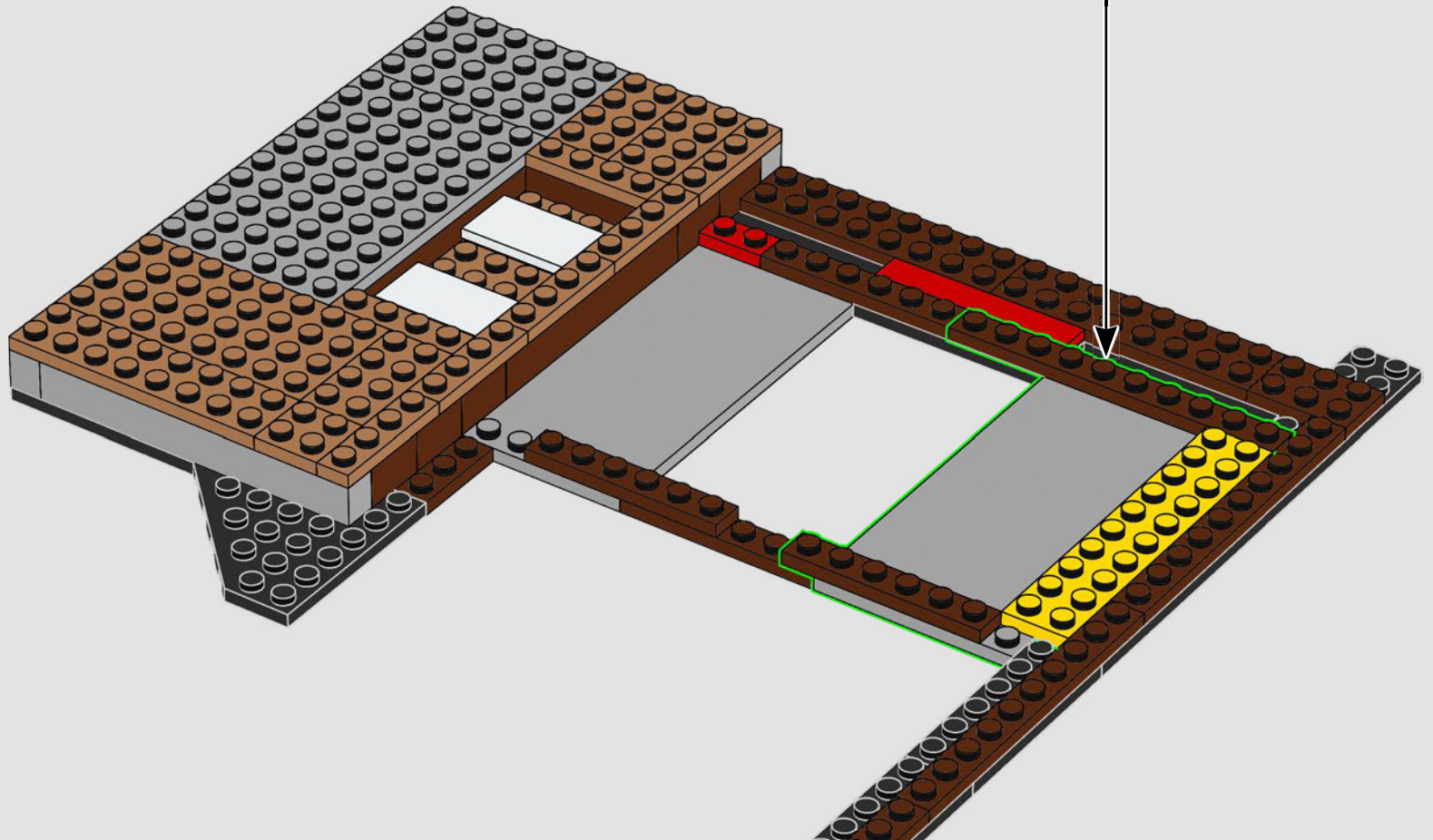

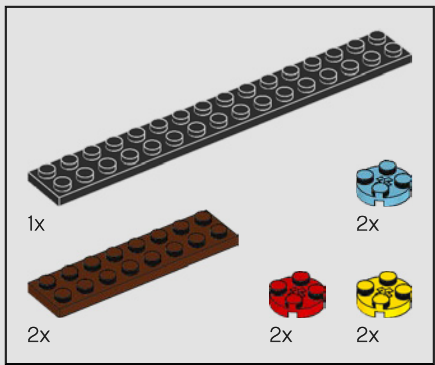

18

1

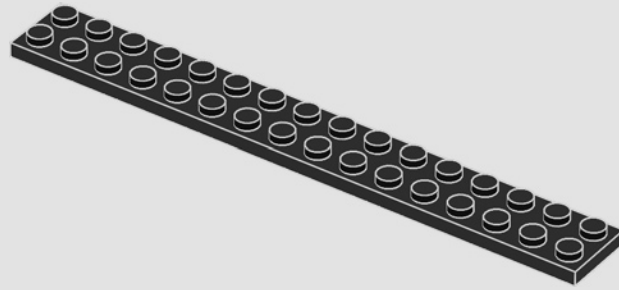

2

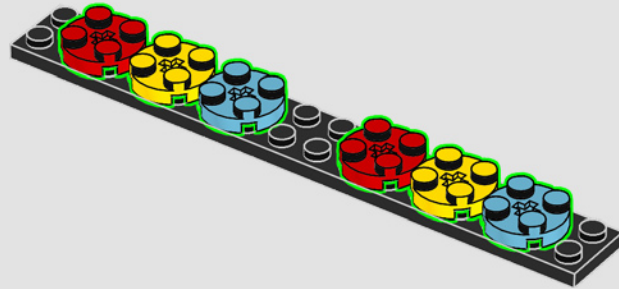

3

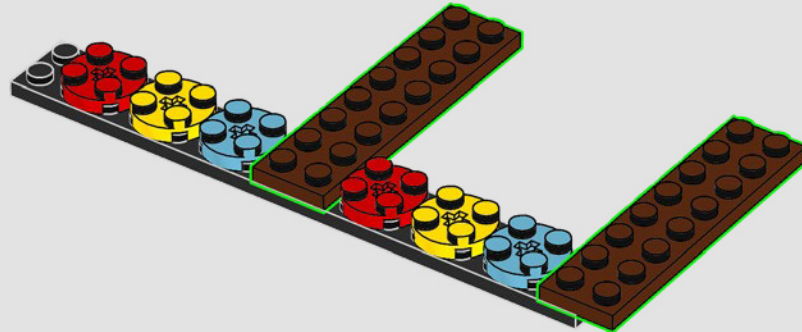



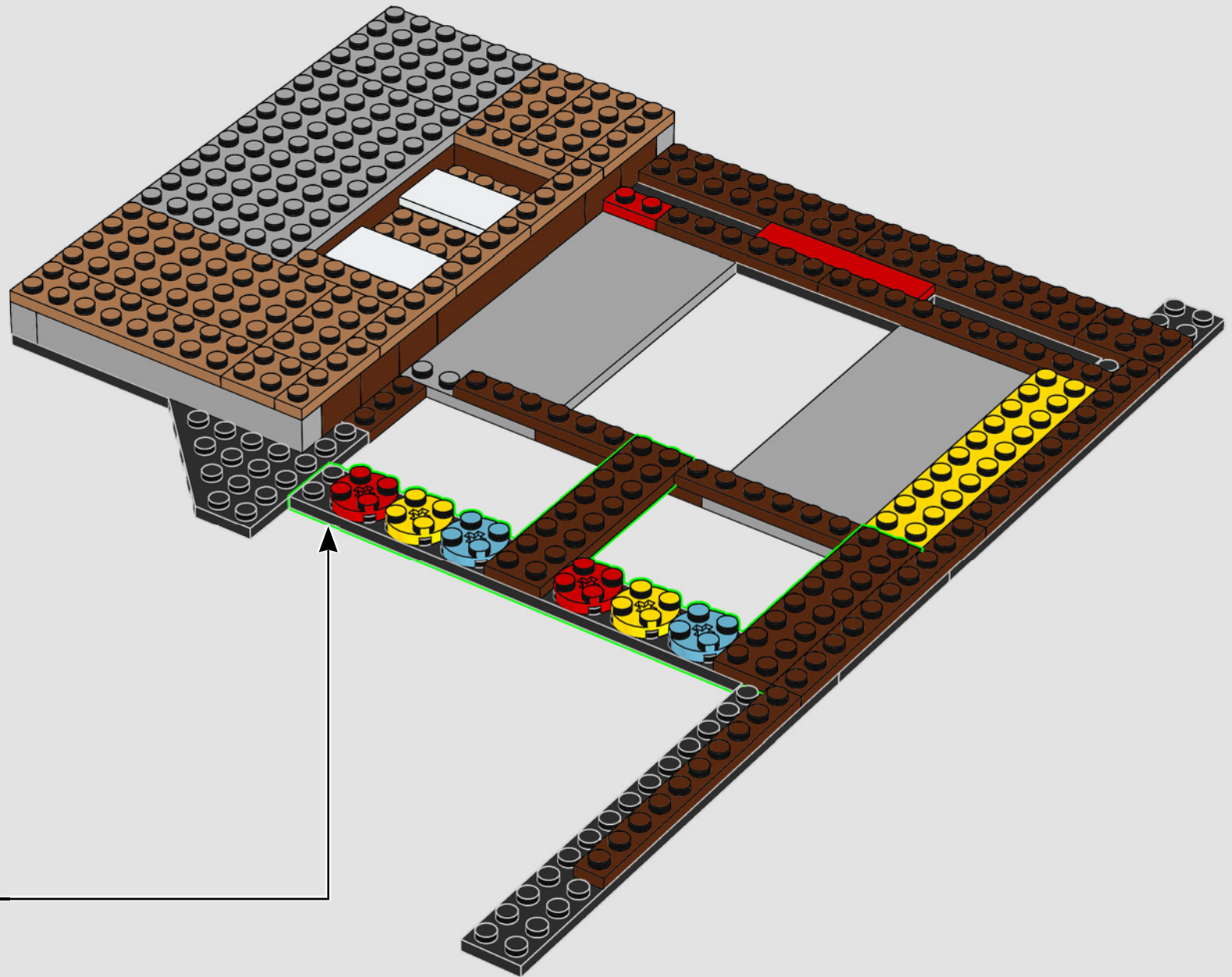



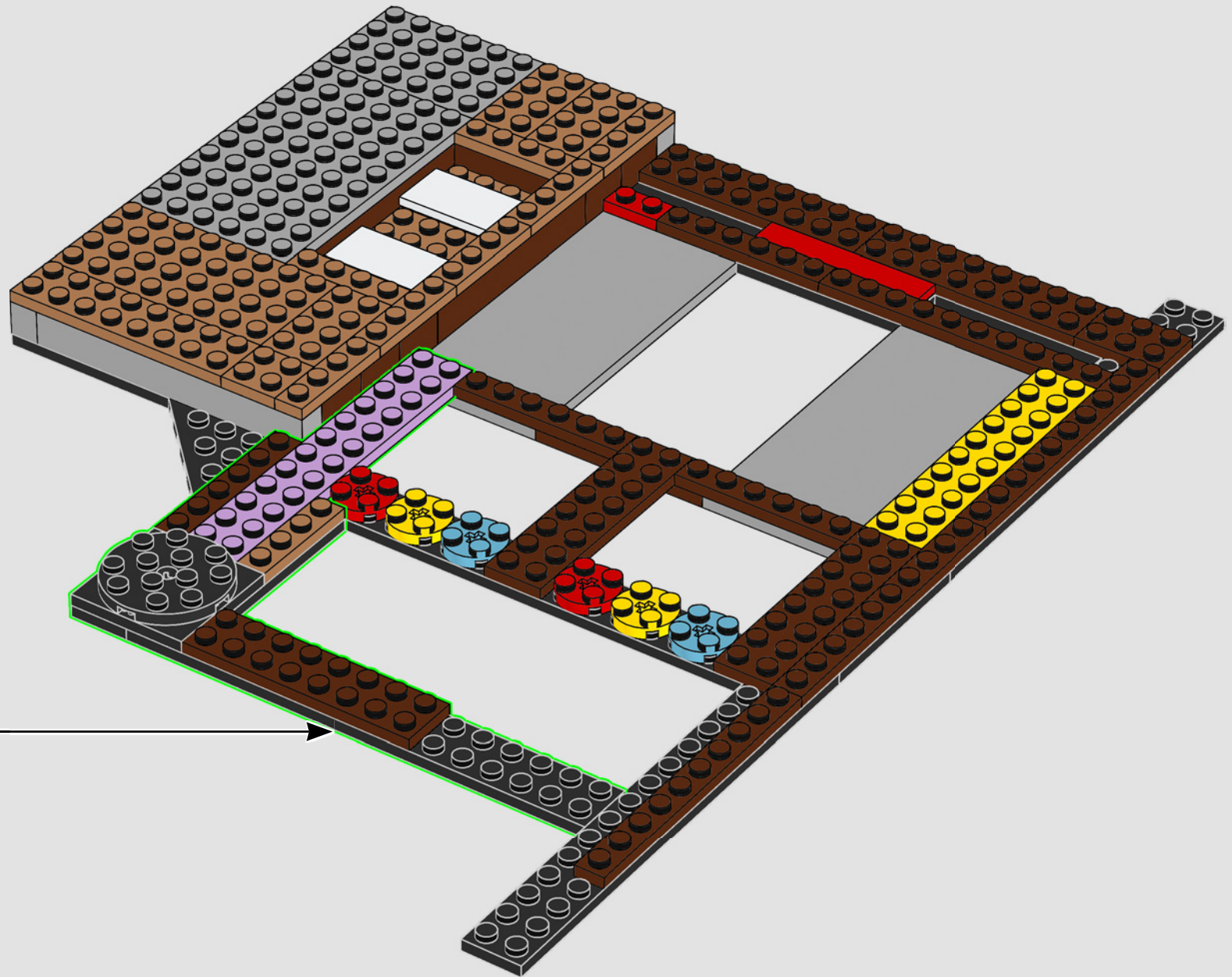



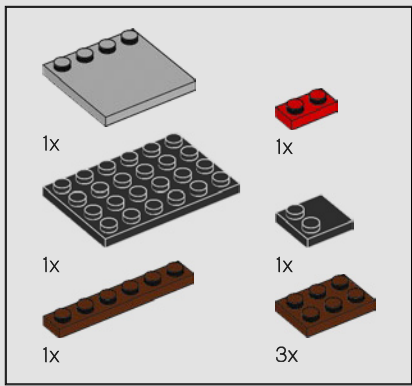

20

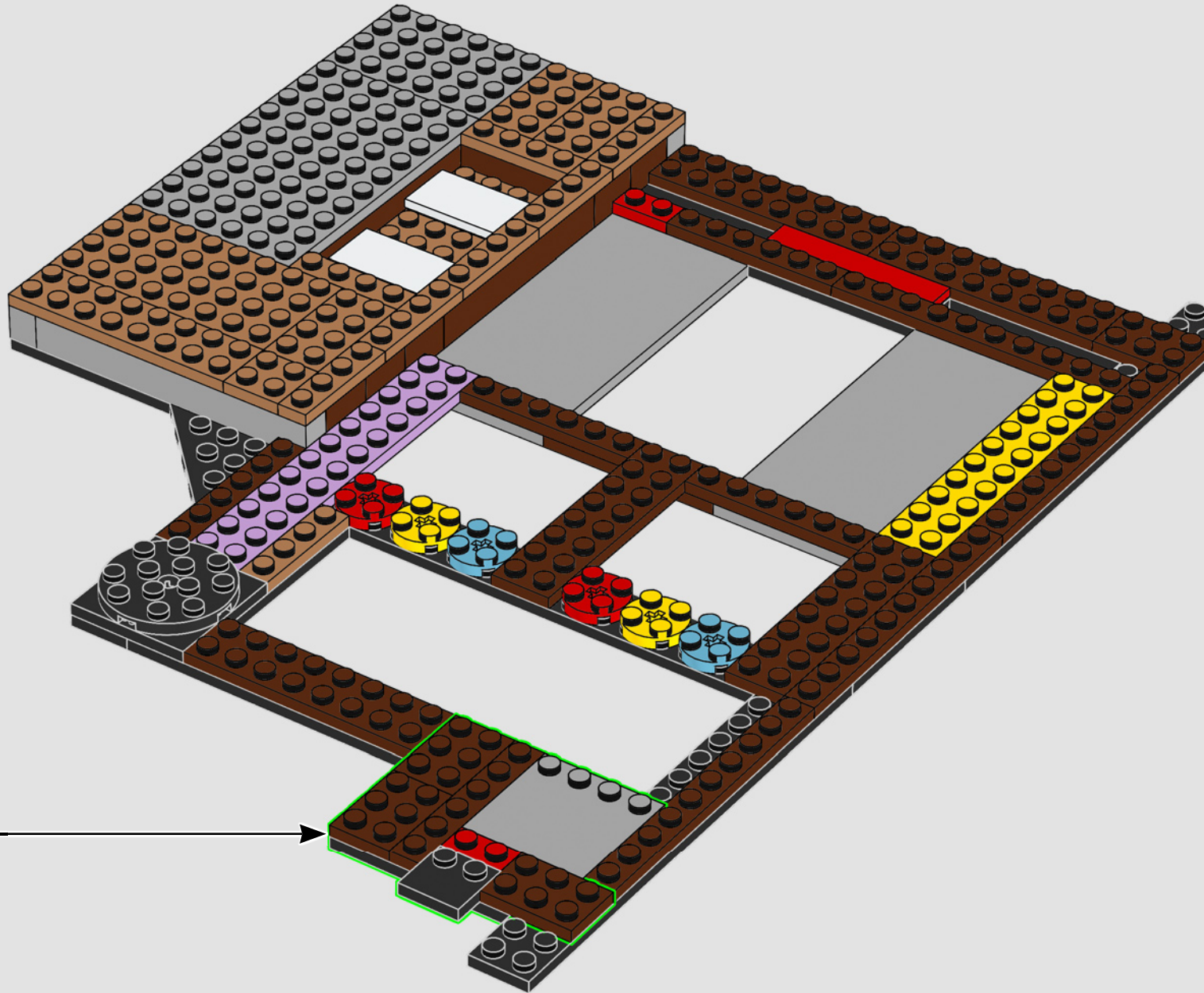
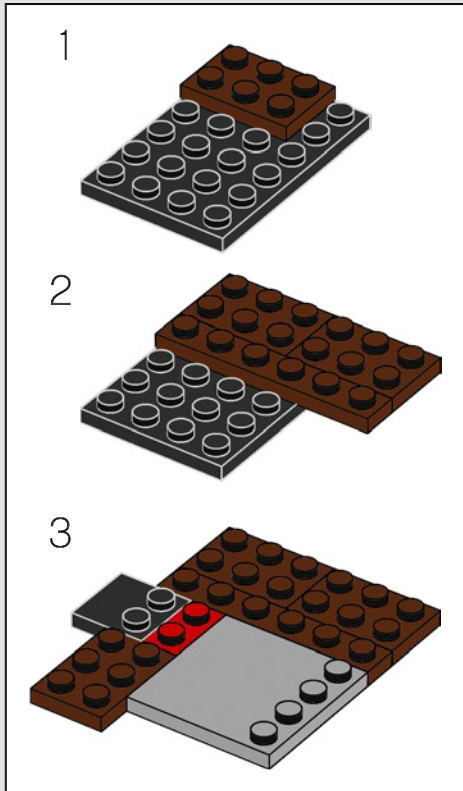

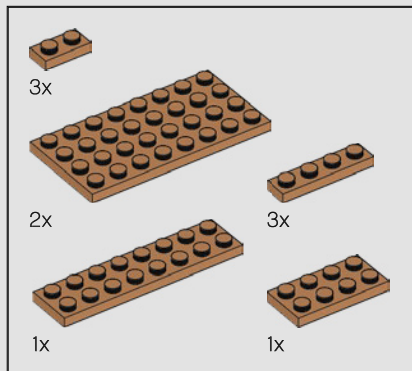

21

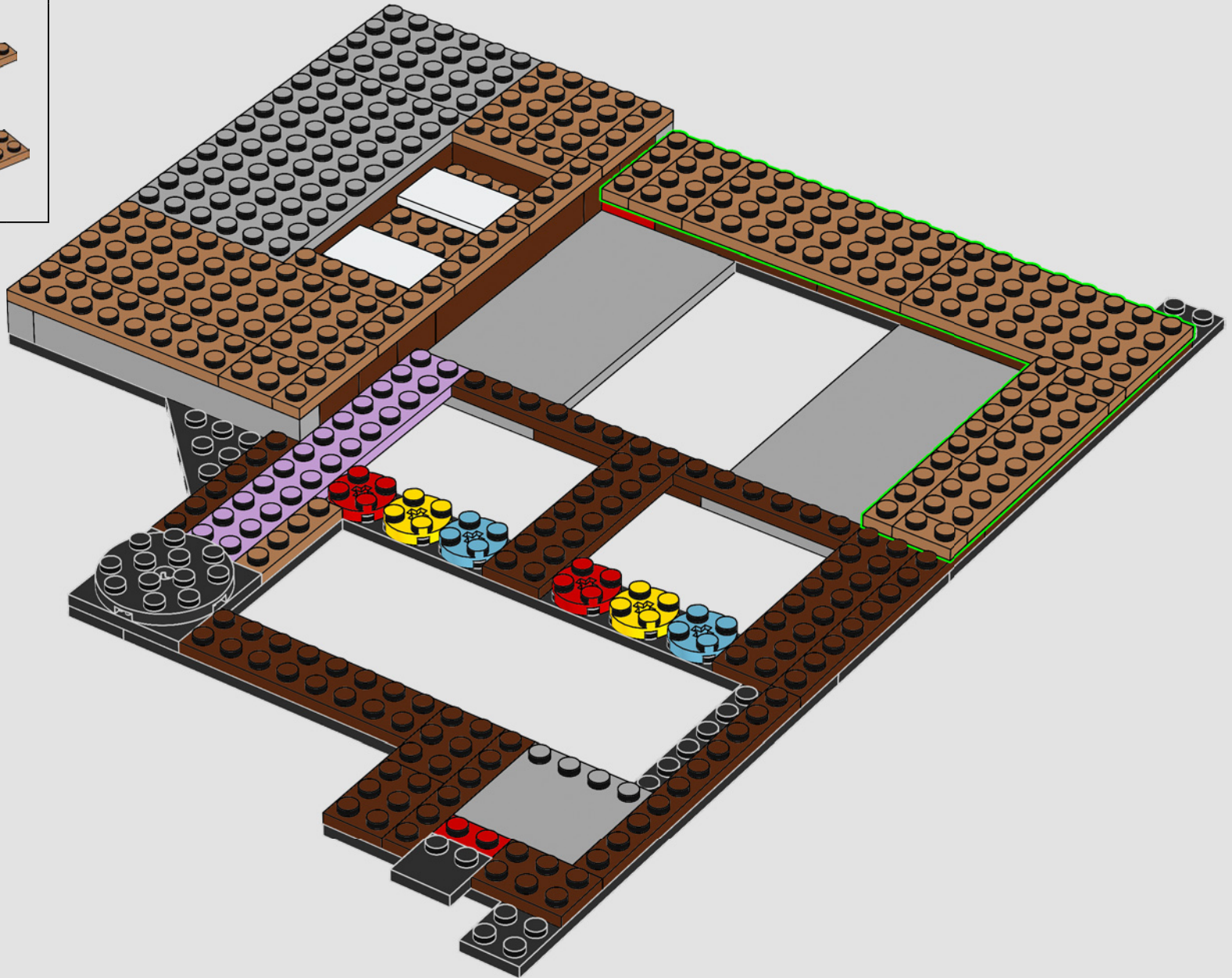



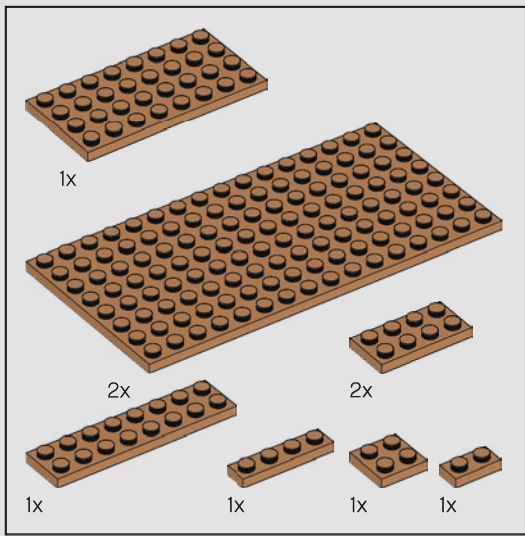

22

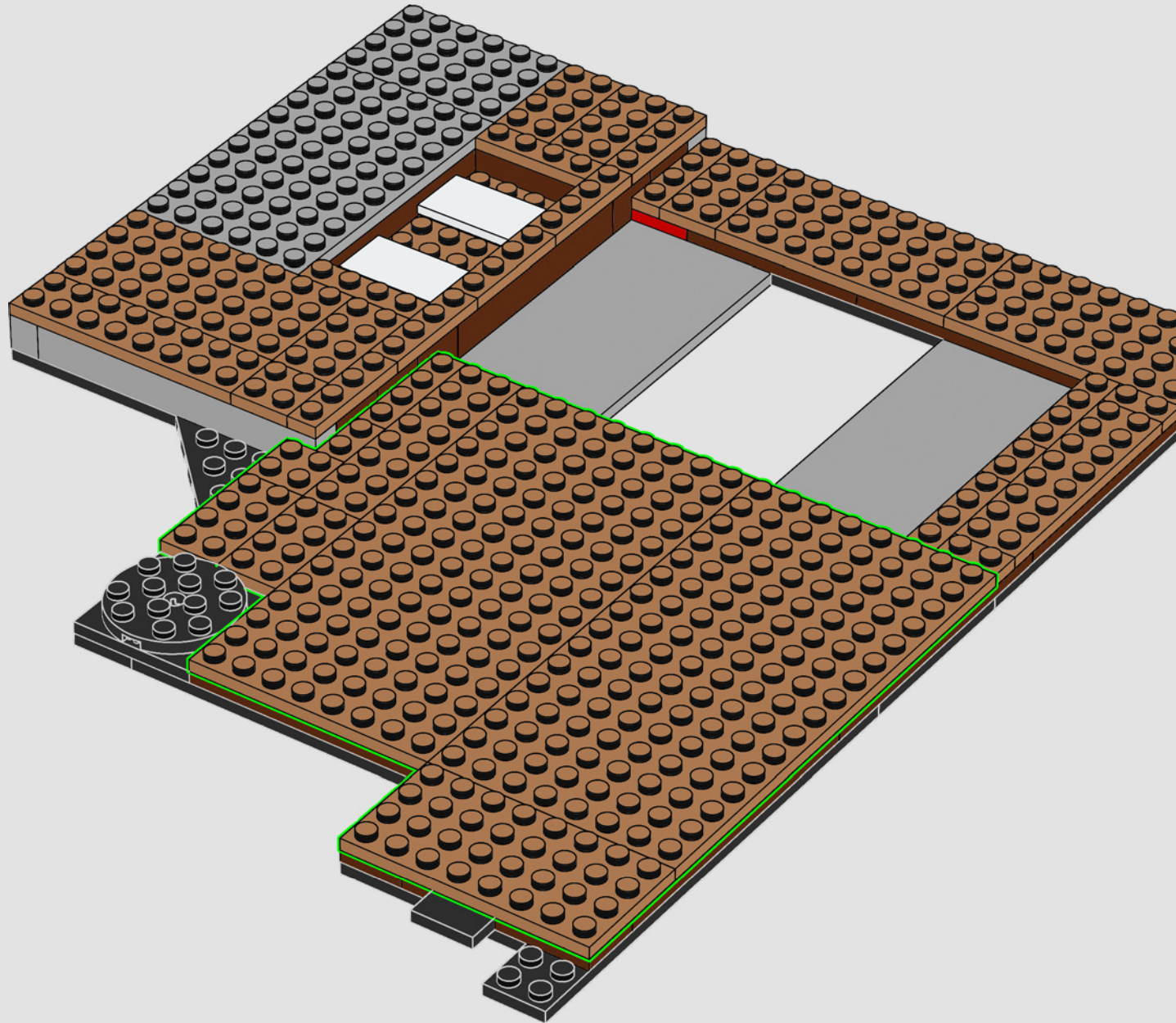



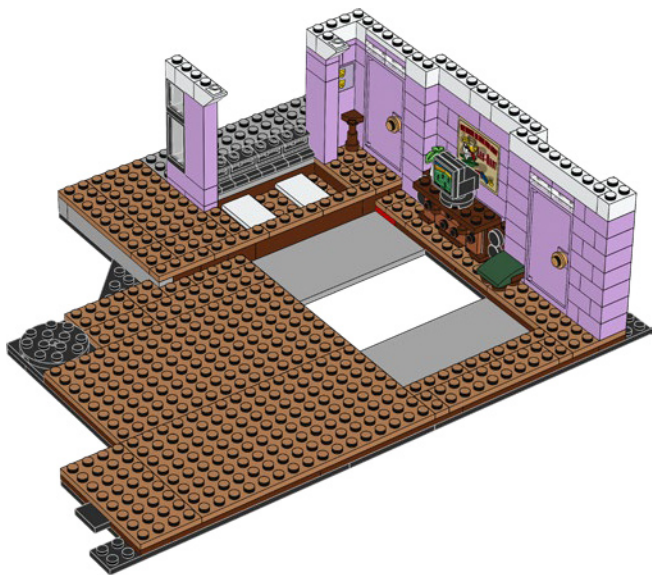



1x

23

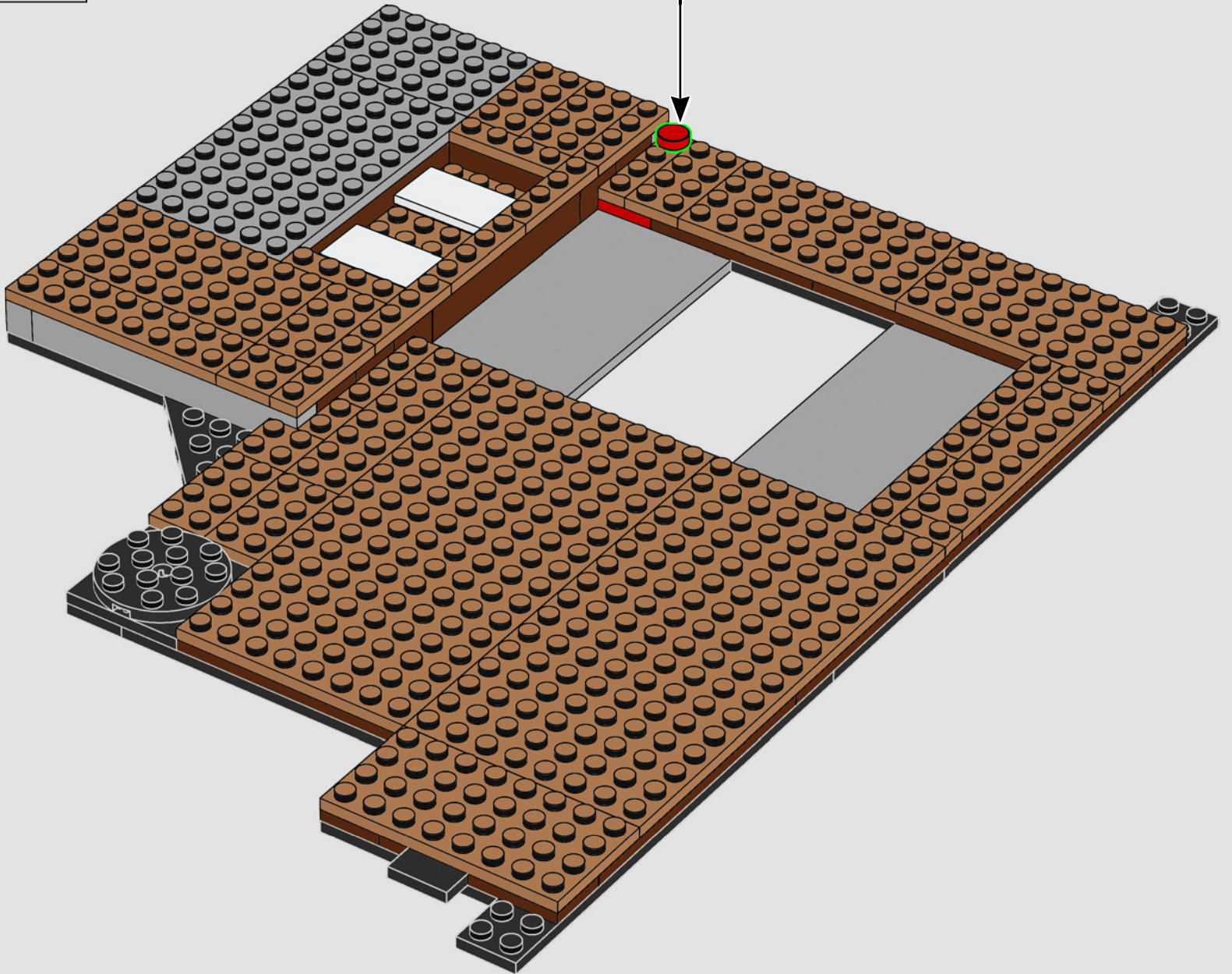

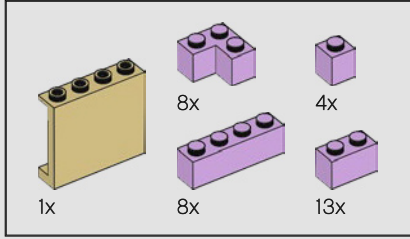
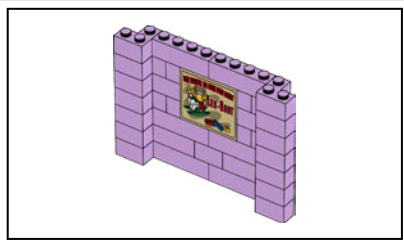

24

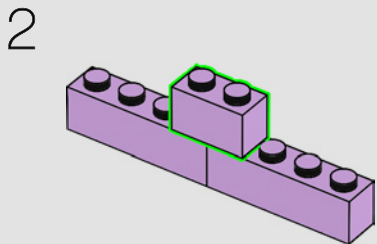
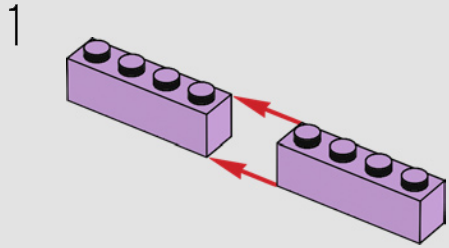

3

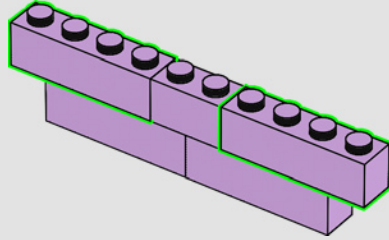

4

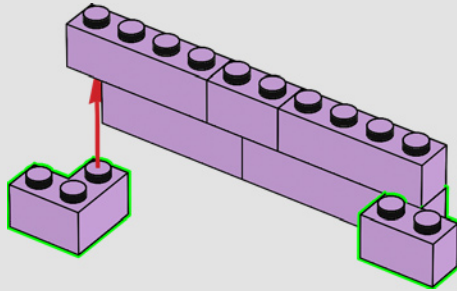

5

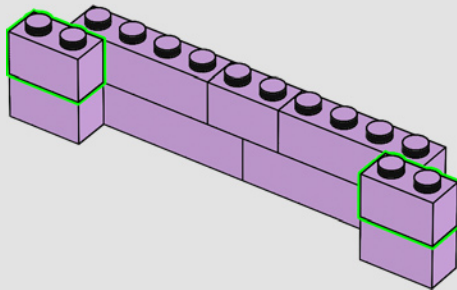

6

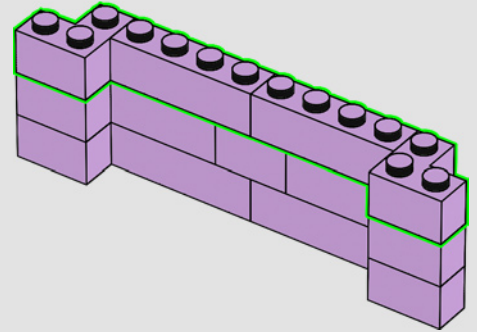

7

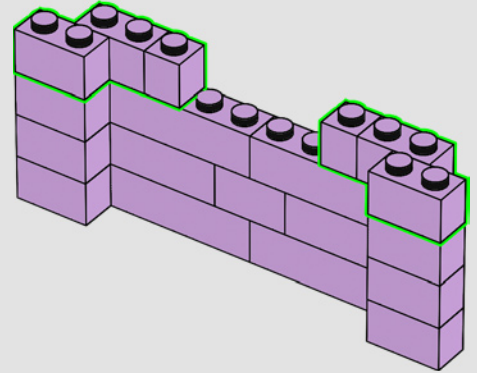

8

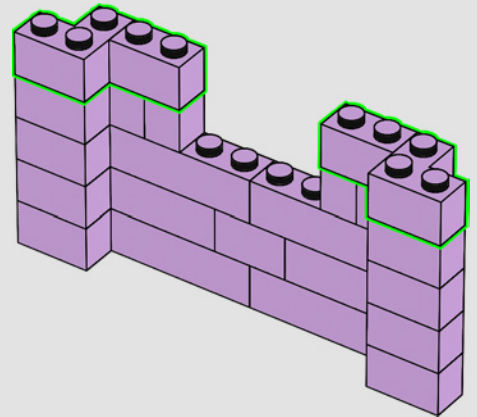



• ¿Recuerdas el gran póster que estaba detrás del televisor, y el famoso espejo con marco dorado de la puerta?

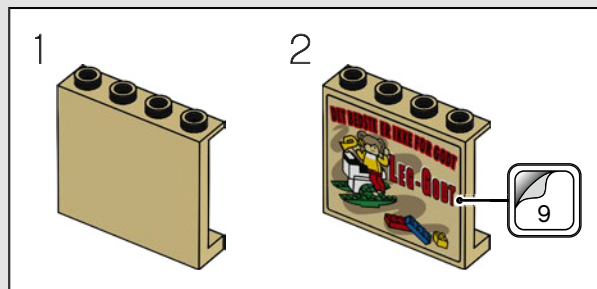

9

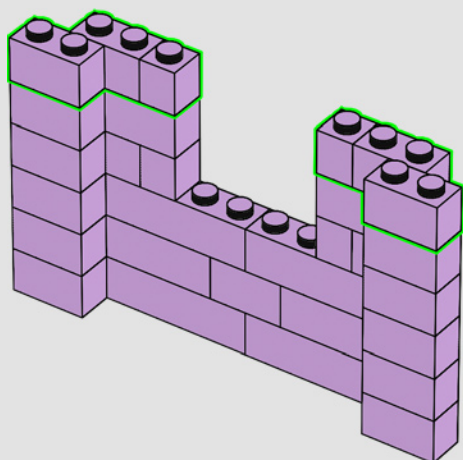

10

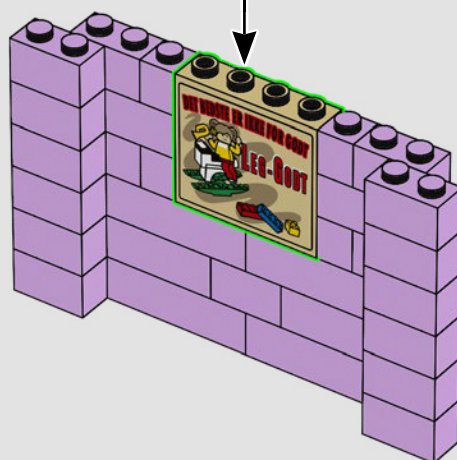

11

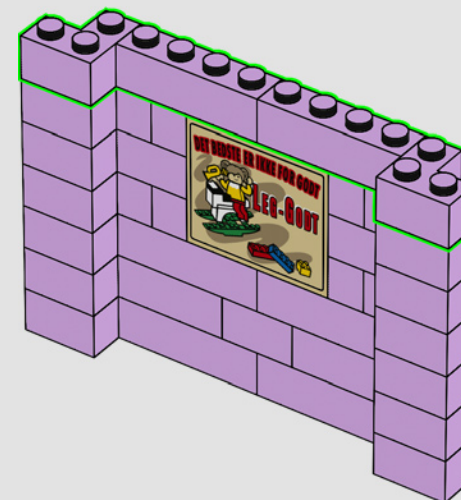

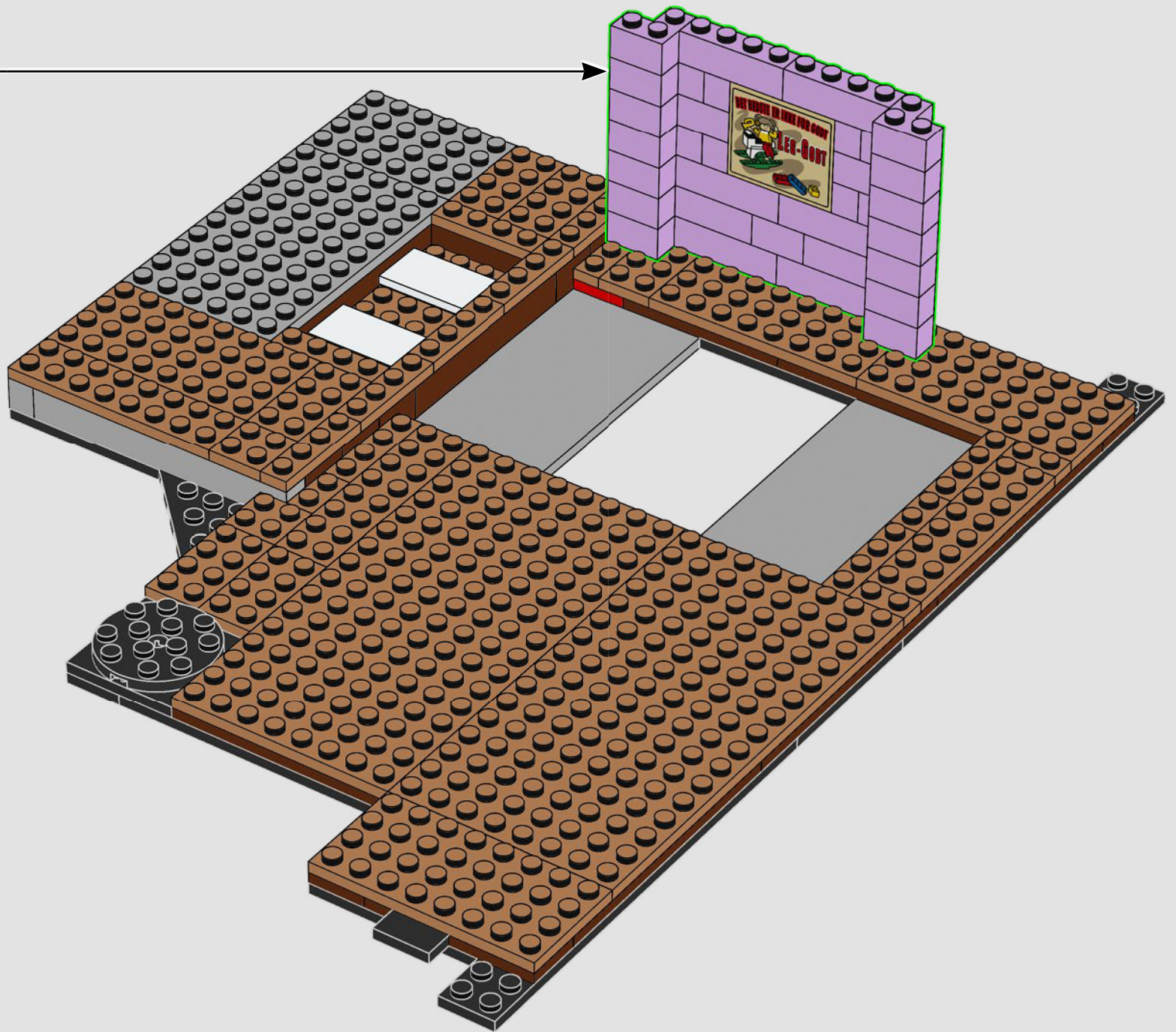



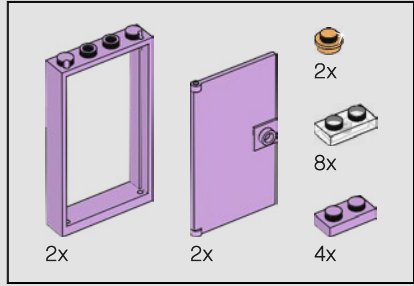

25

1

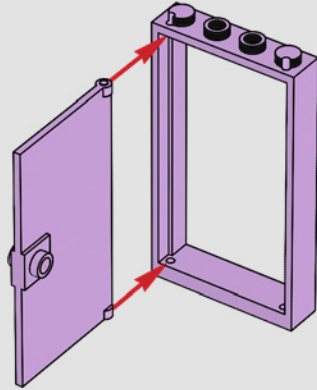

2

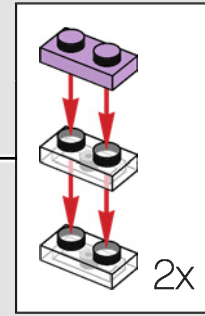

3

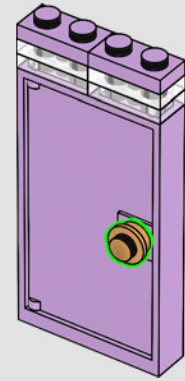

2x

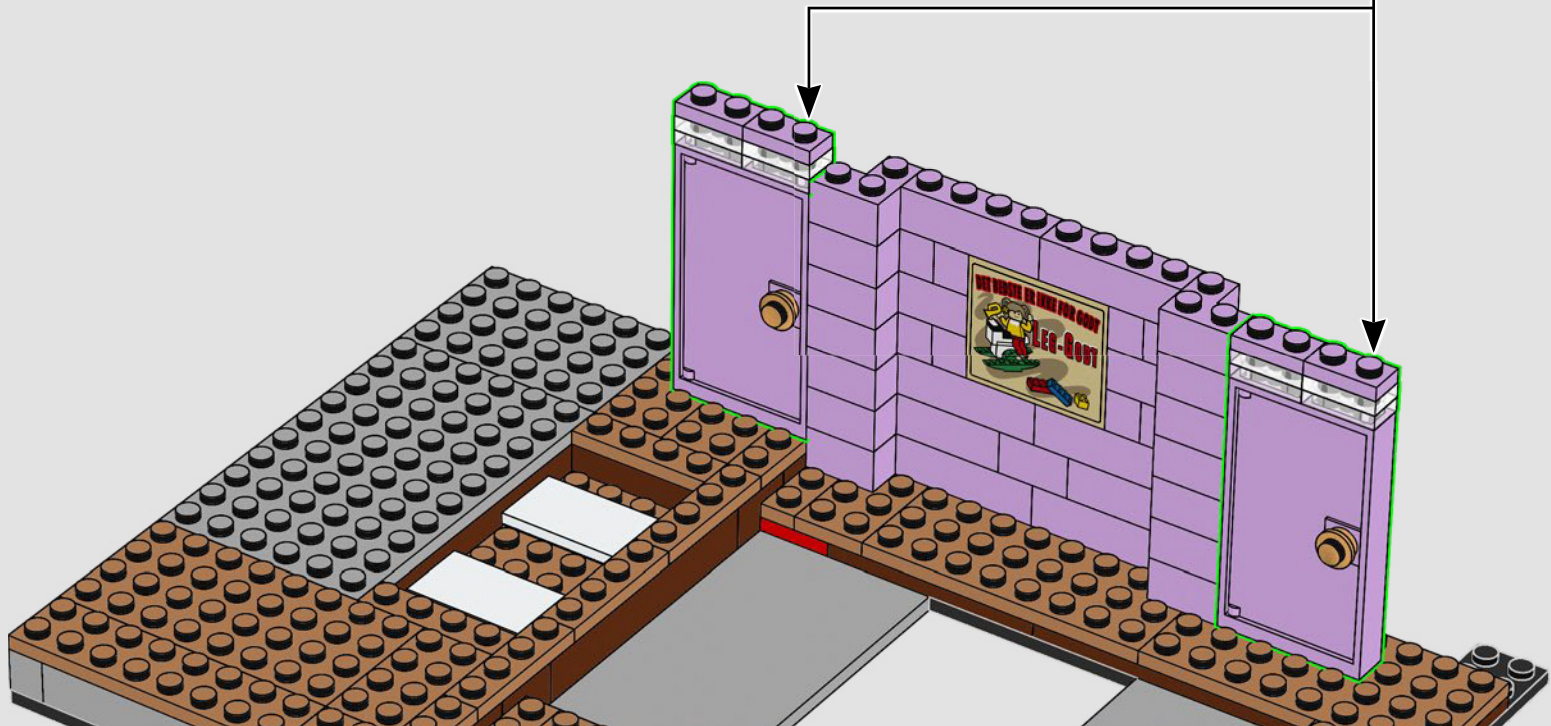



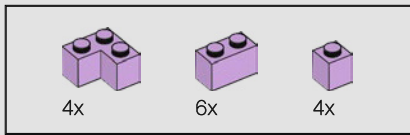

26

1

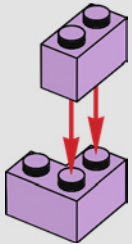

2

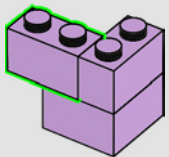

3

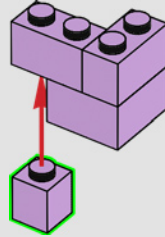

4

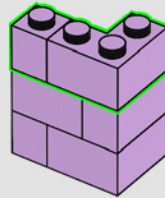

5

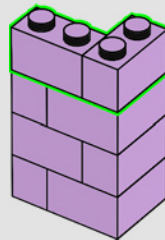

6

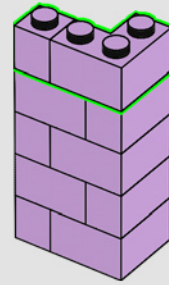

7

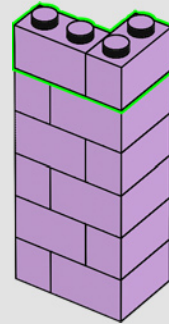

8

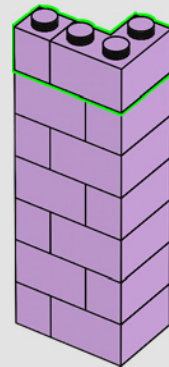

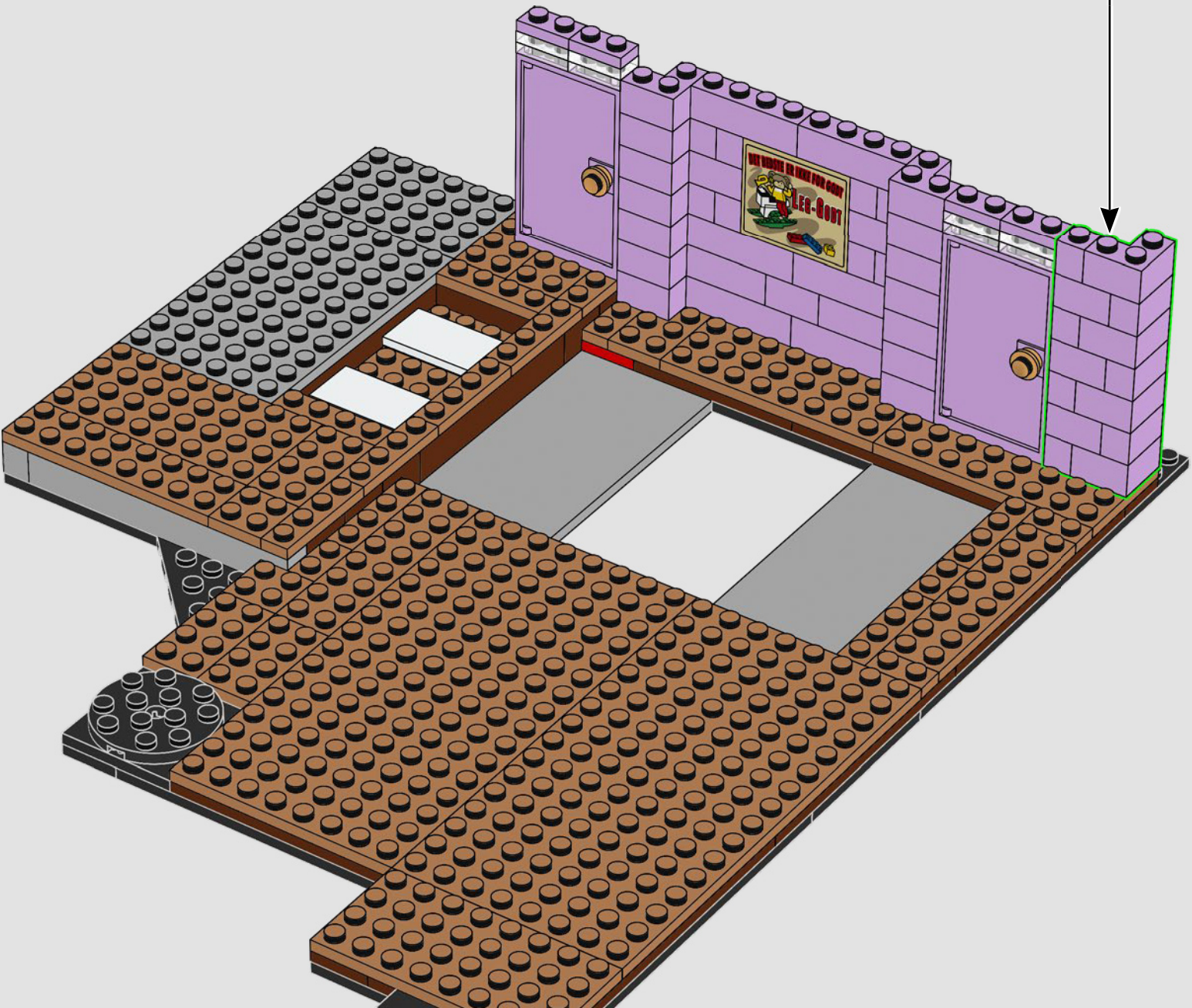



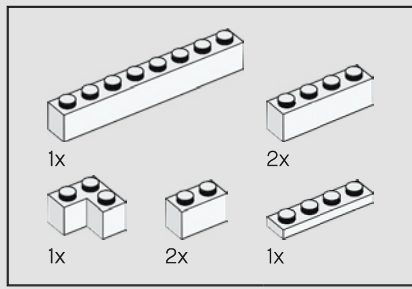

27

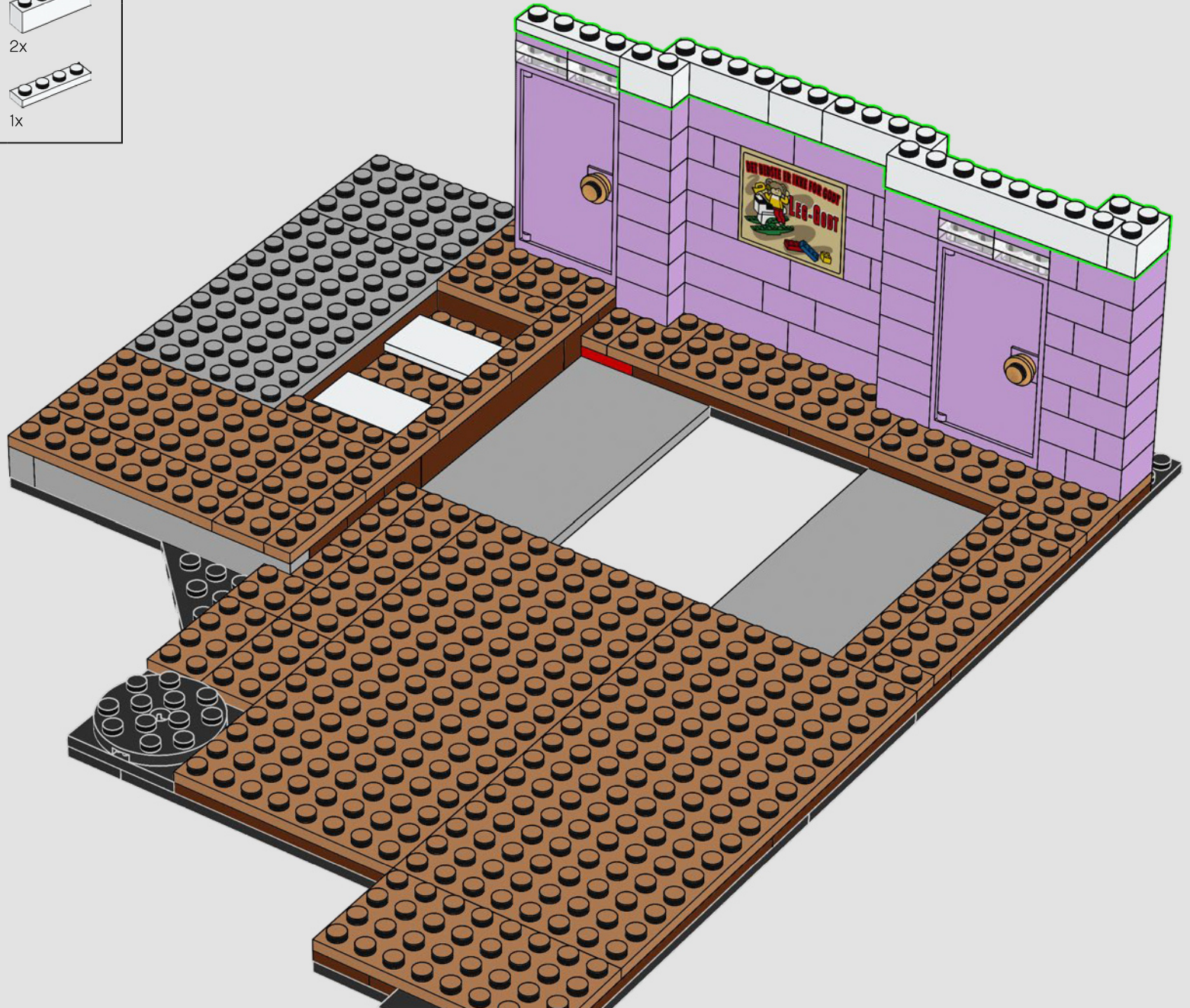



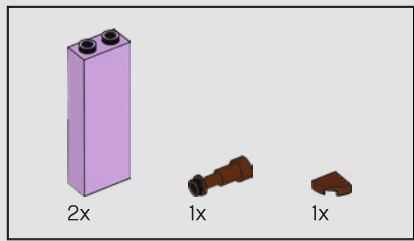

28

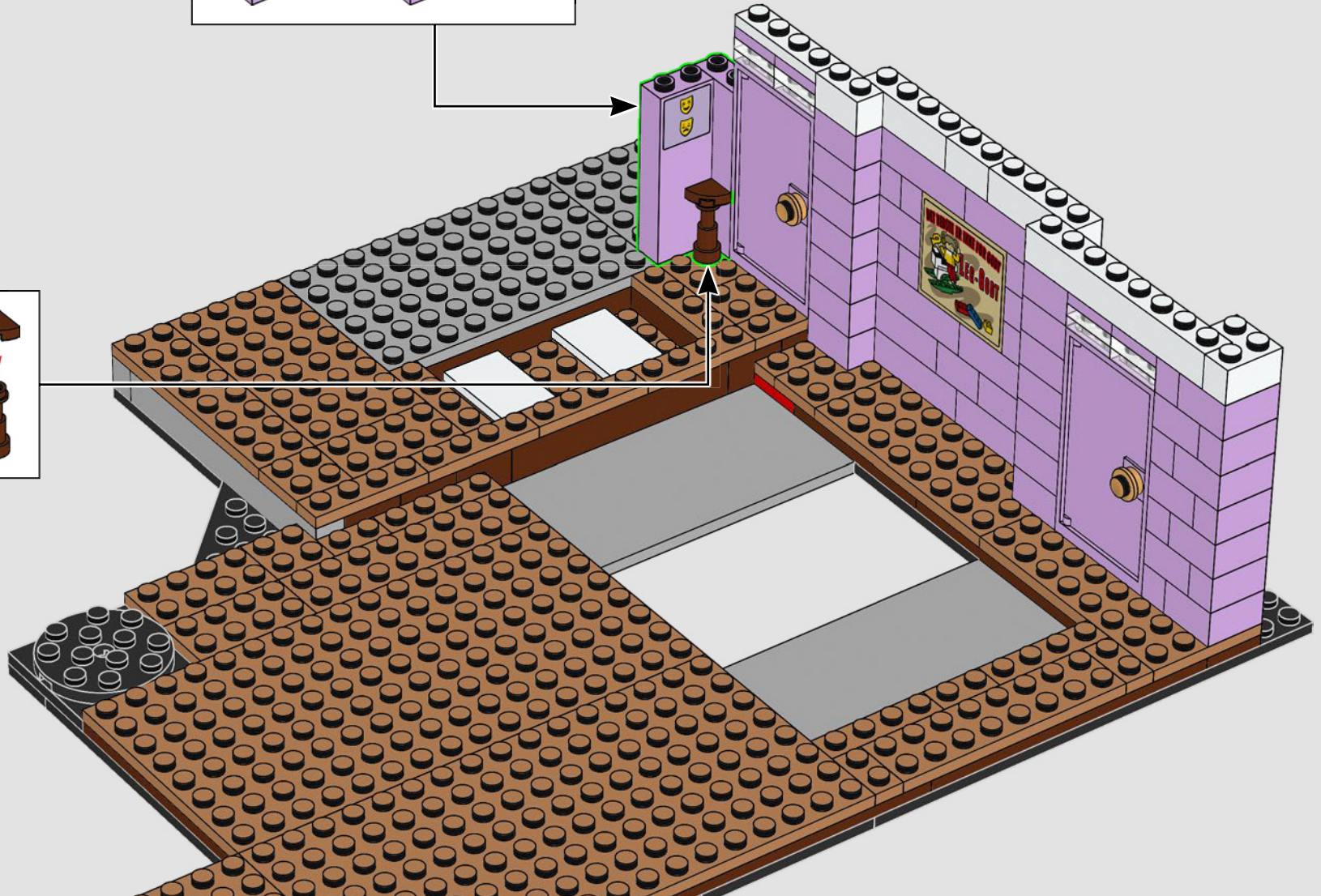
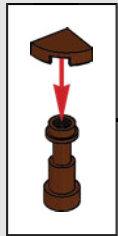
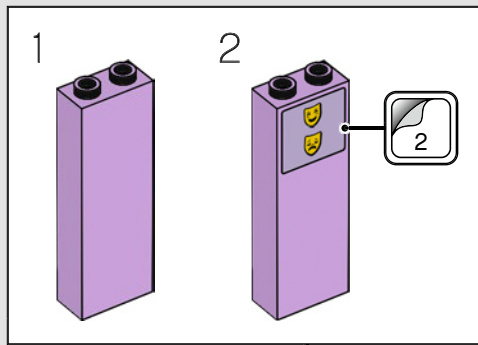



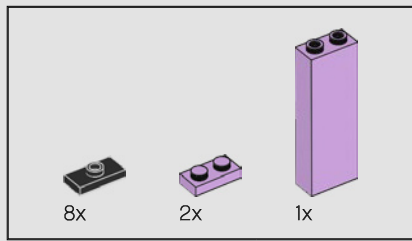

29

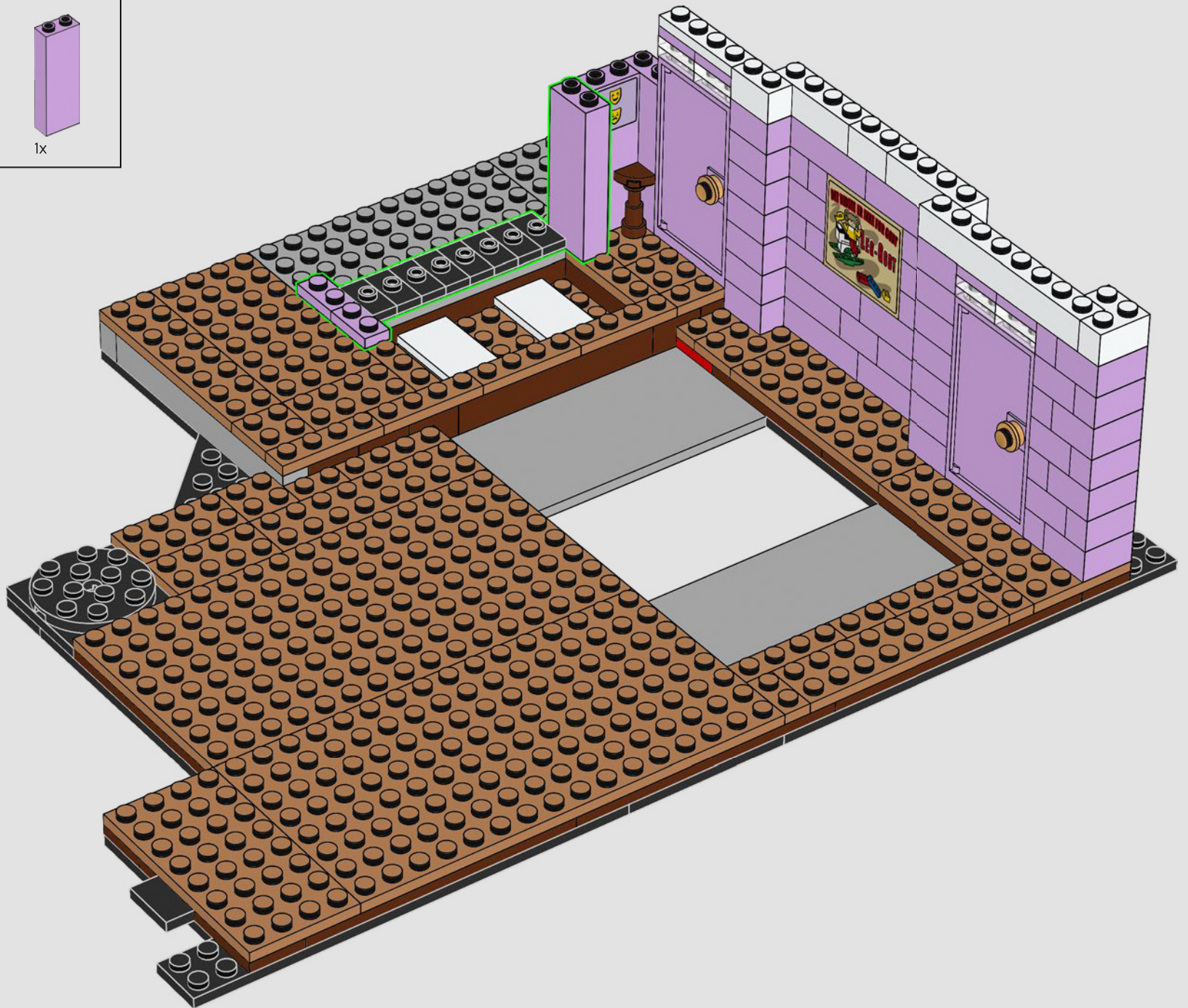



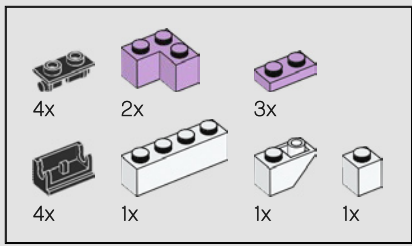

30

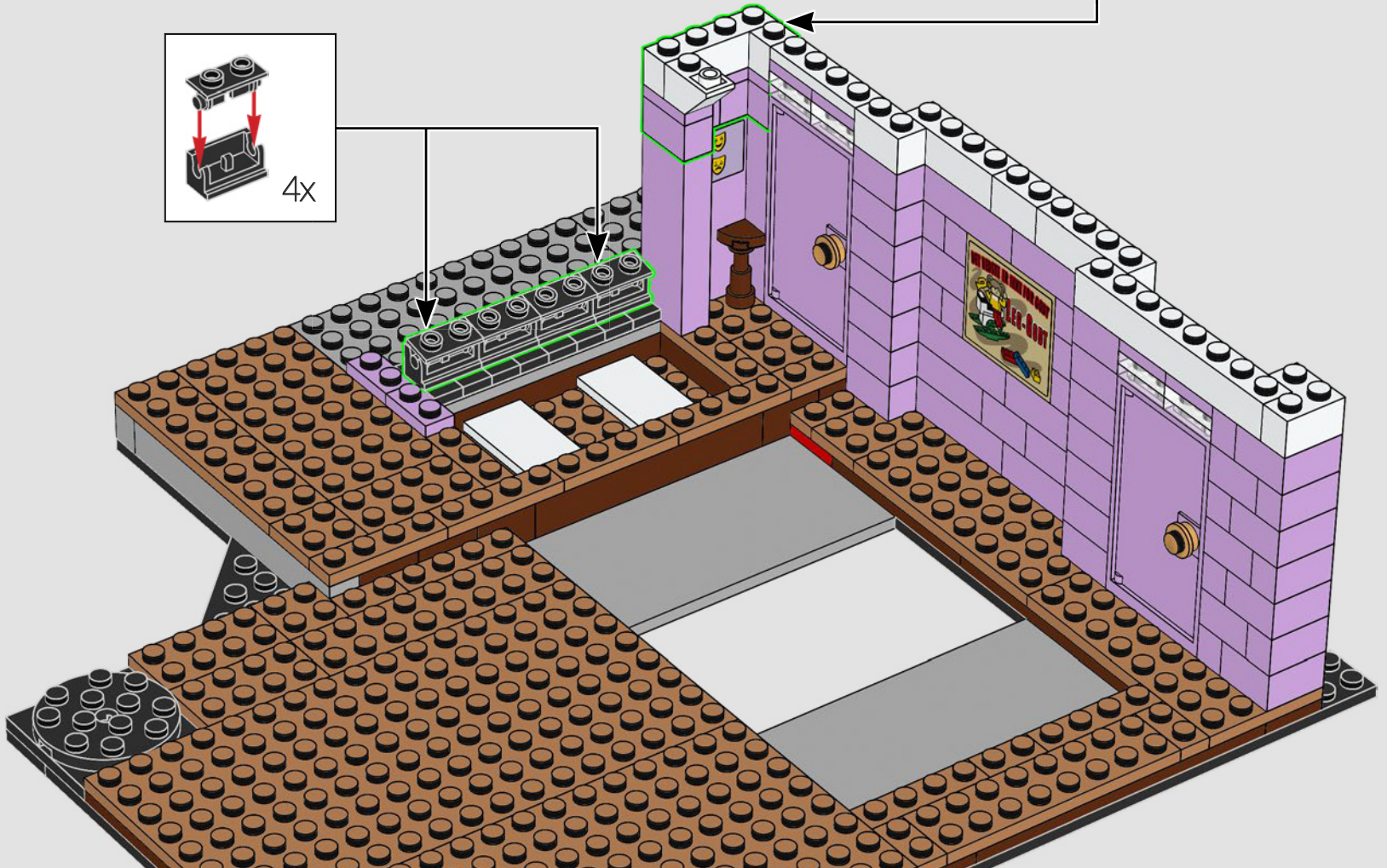
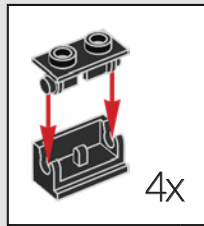
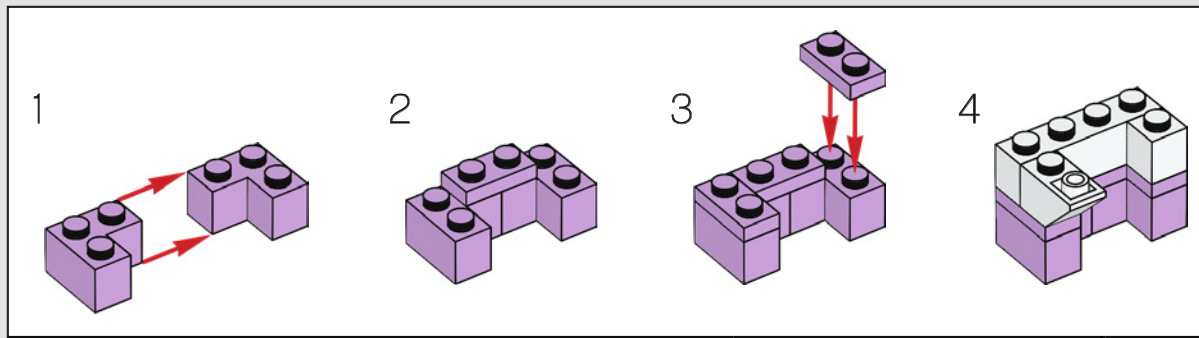



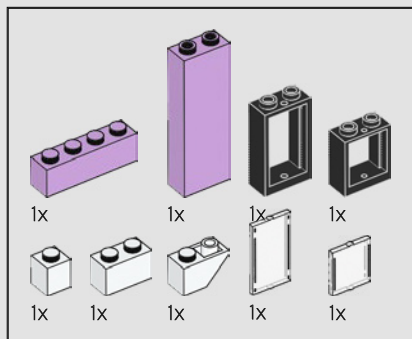

31

1

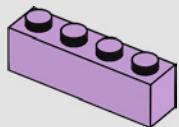

2

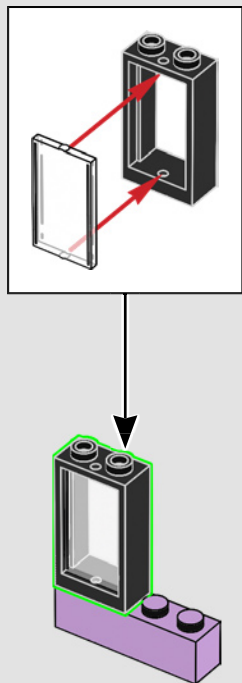

3

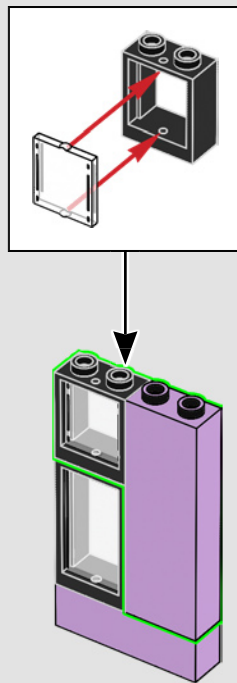

4

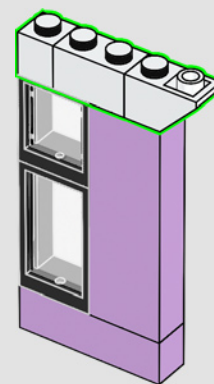

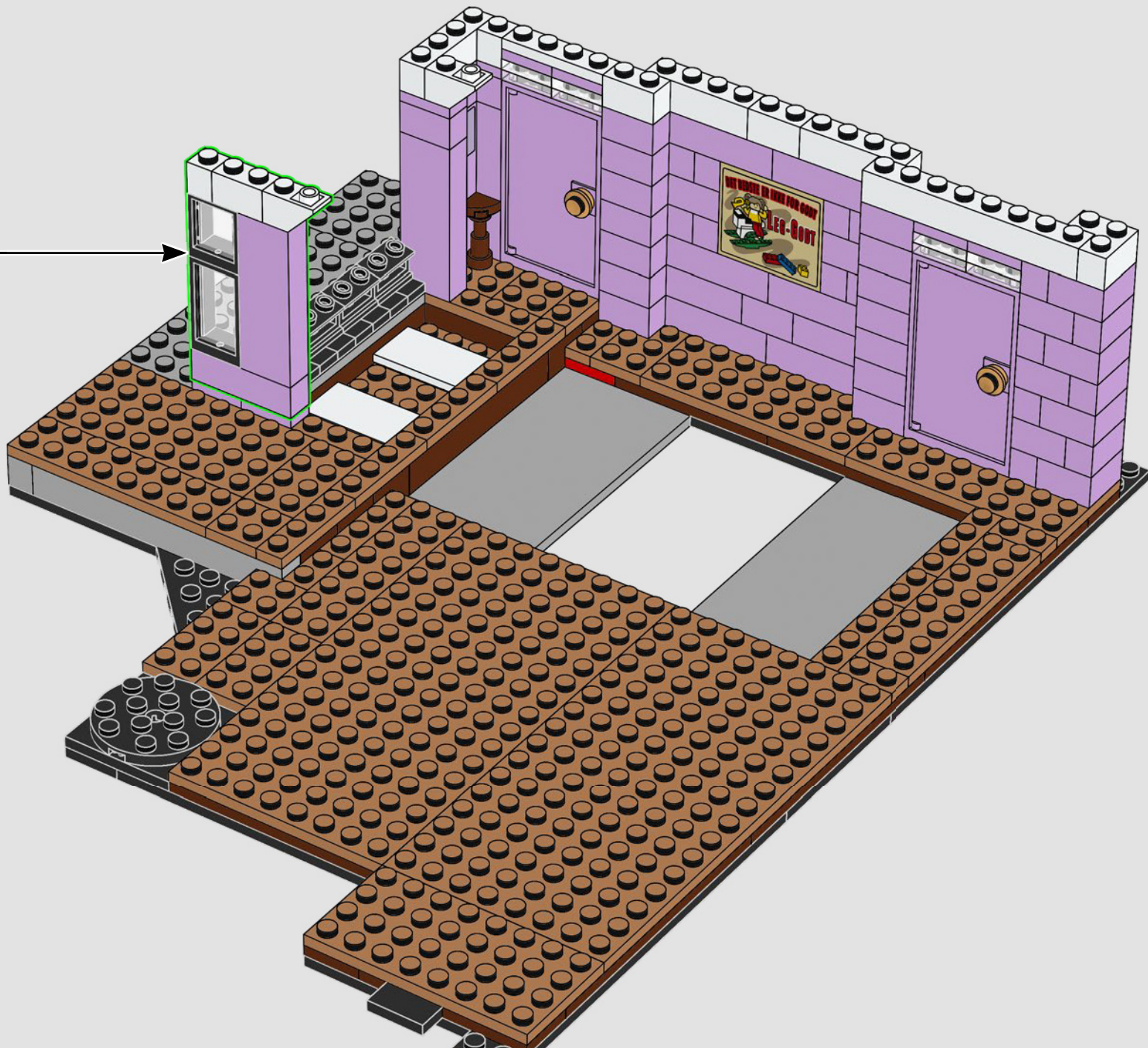



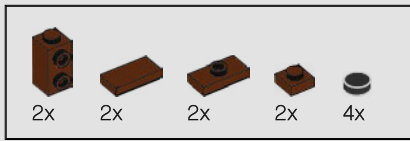

32

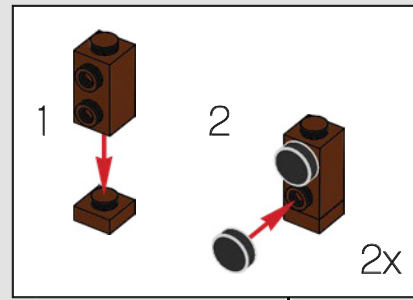



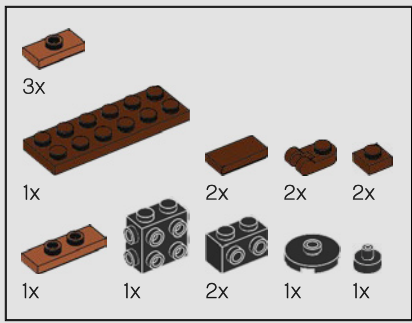

33

1

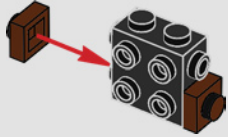

2

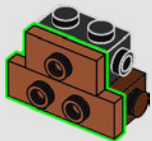

3

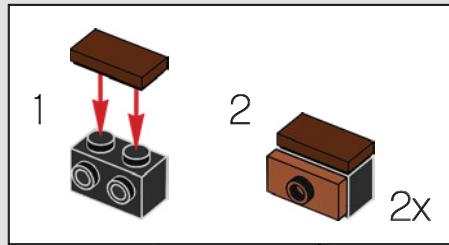
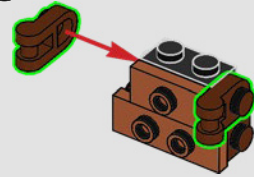

4

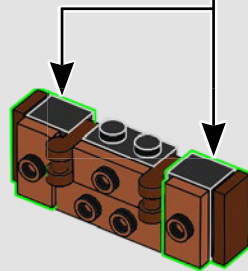

5

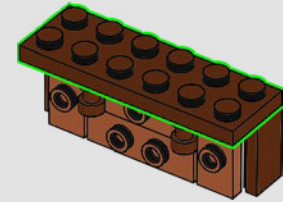

6

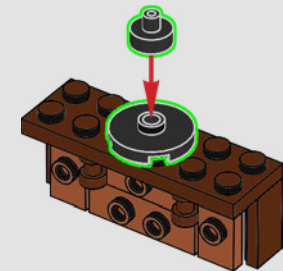





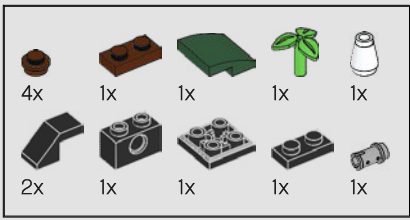

34

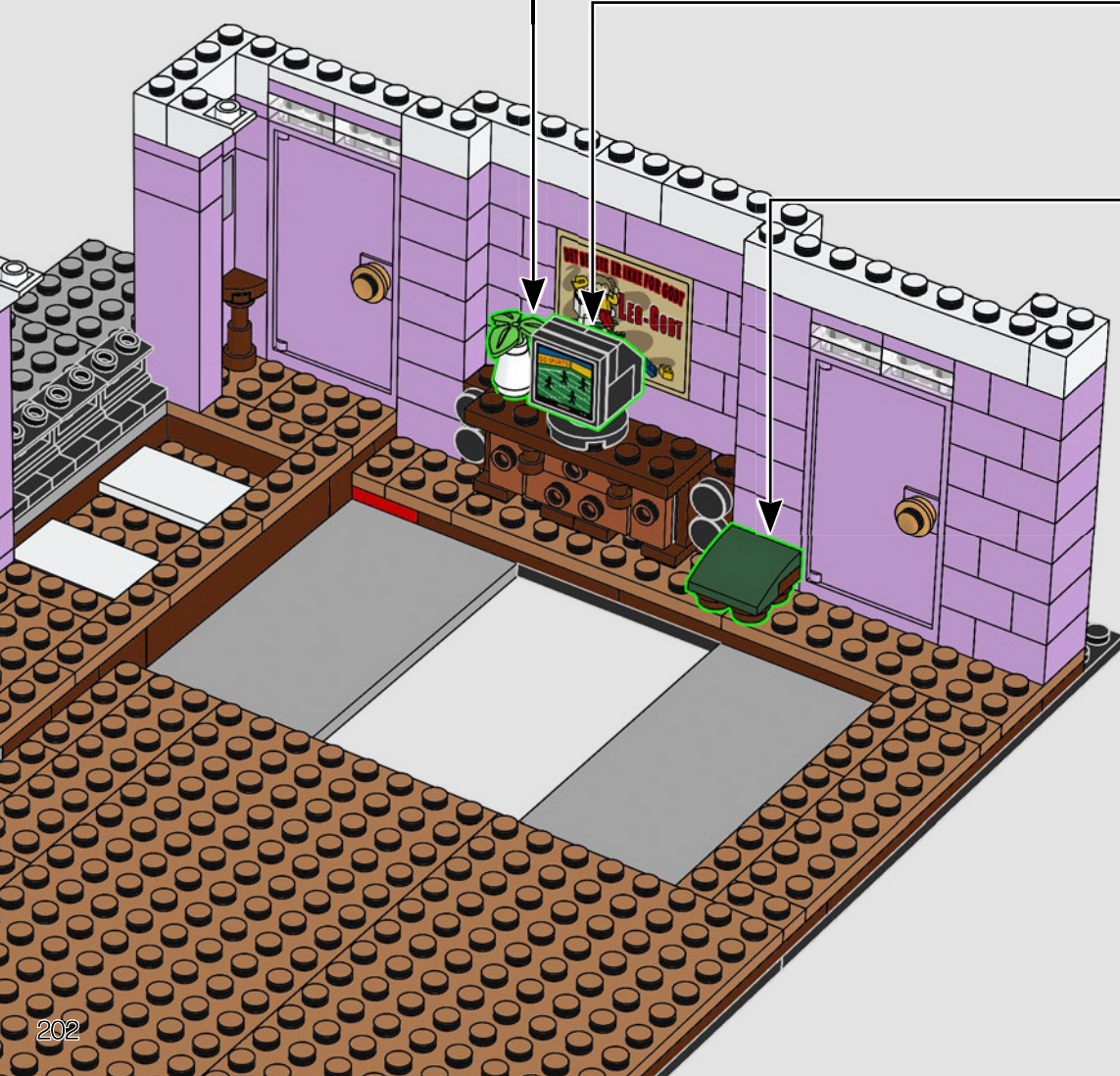
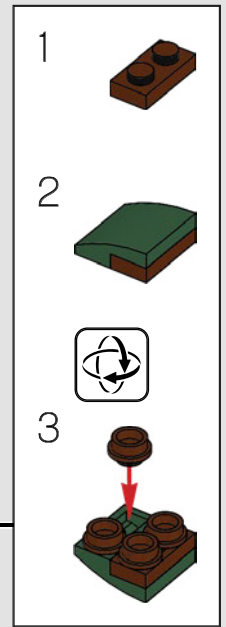
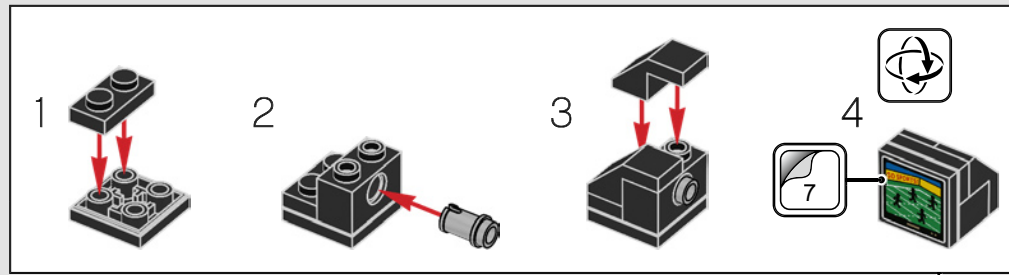
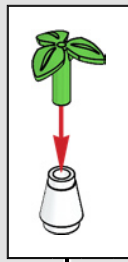

• Todos decidieron ver un partido de fútbol americano en este televisor el Día de Acción de Gracias para evitar ayudarle a cocinar a Monica.





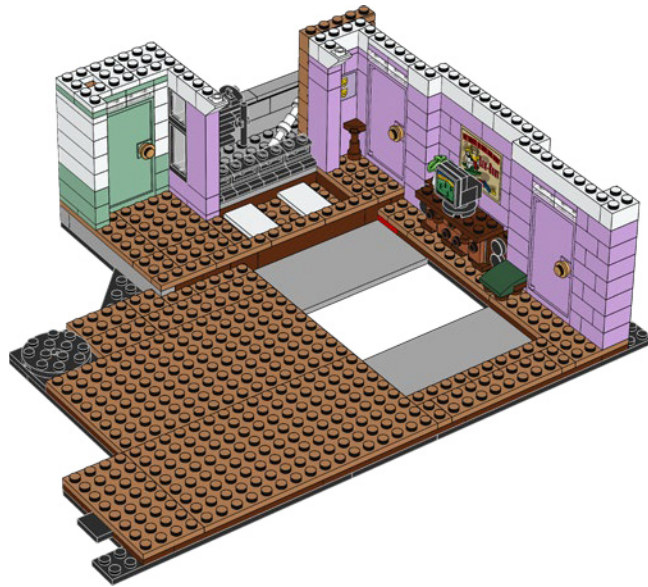

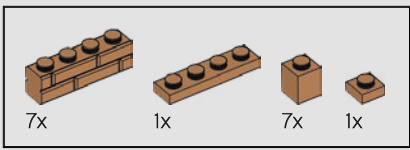

35

1

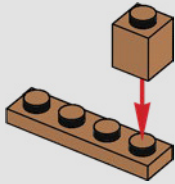

2

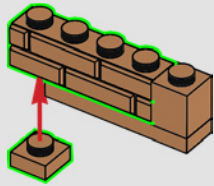

3

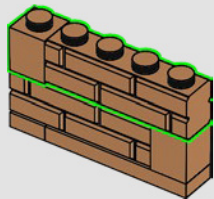

4

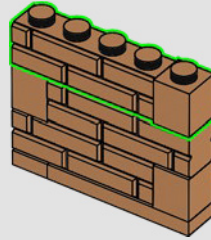

5

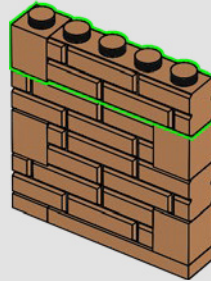

6

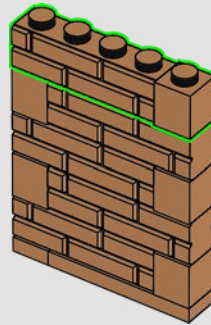

7

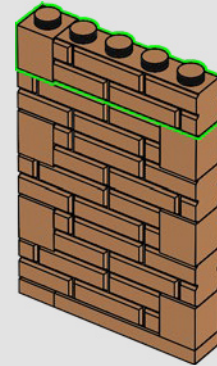

8

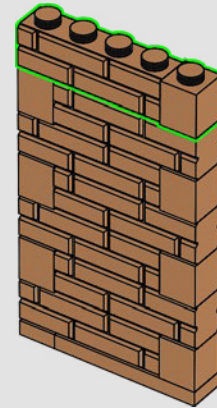

• Monica tenía una manera muy particular de decidir la forma de colocar sus muebles, incluida esta otomana verde.

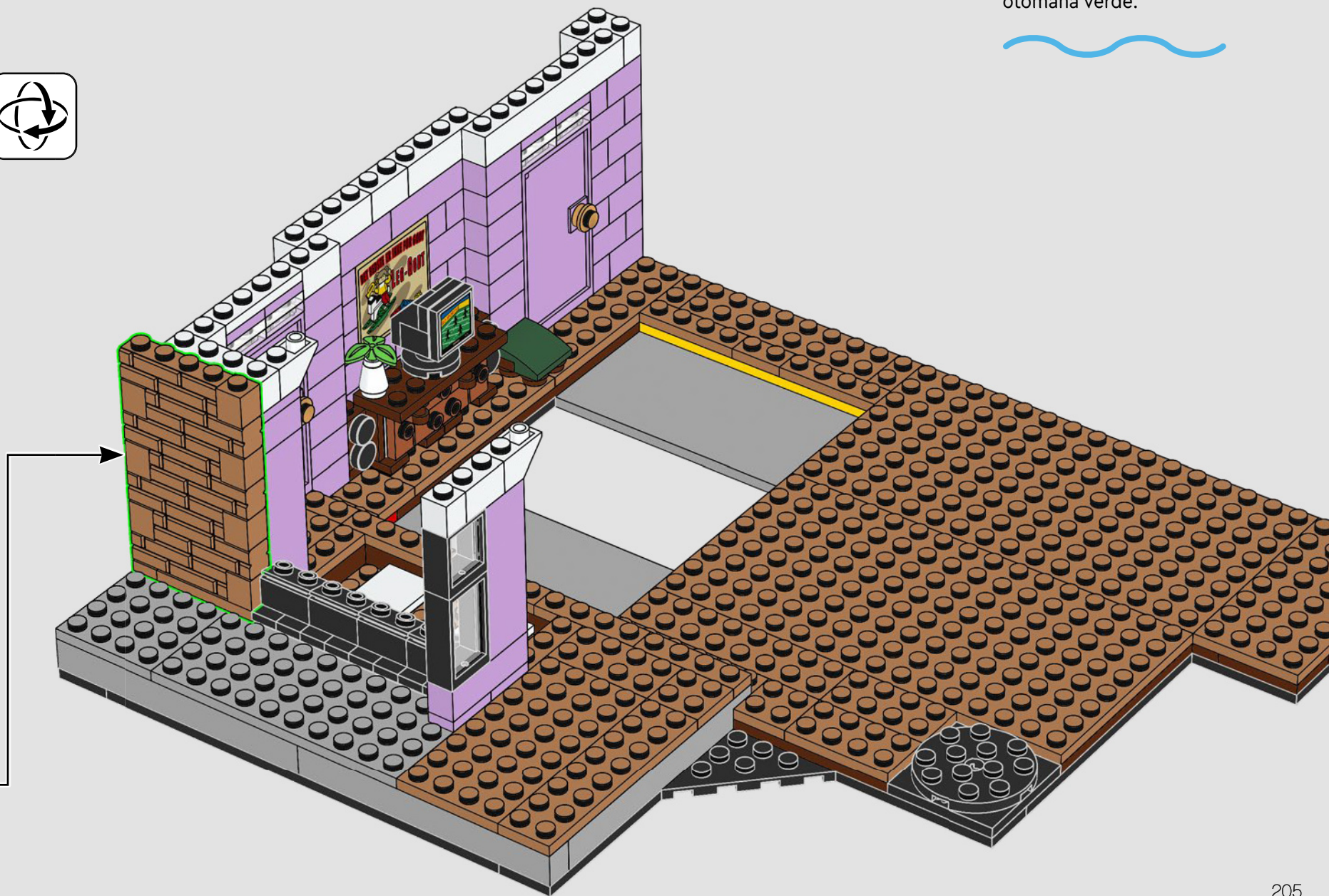



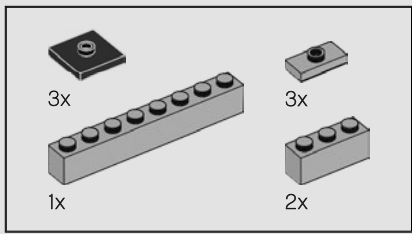

36

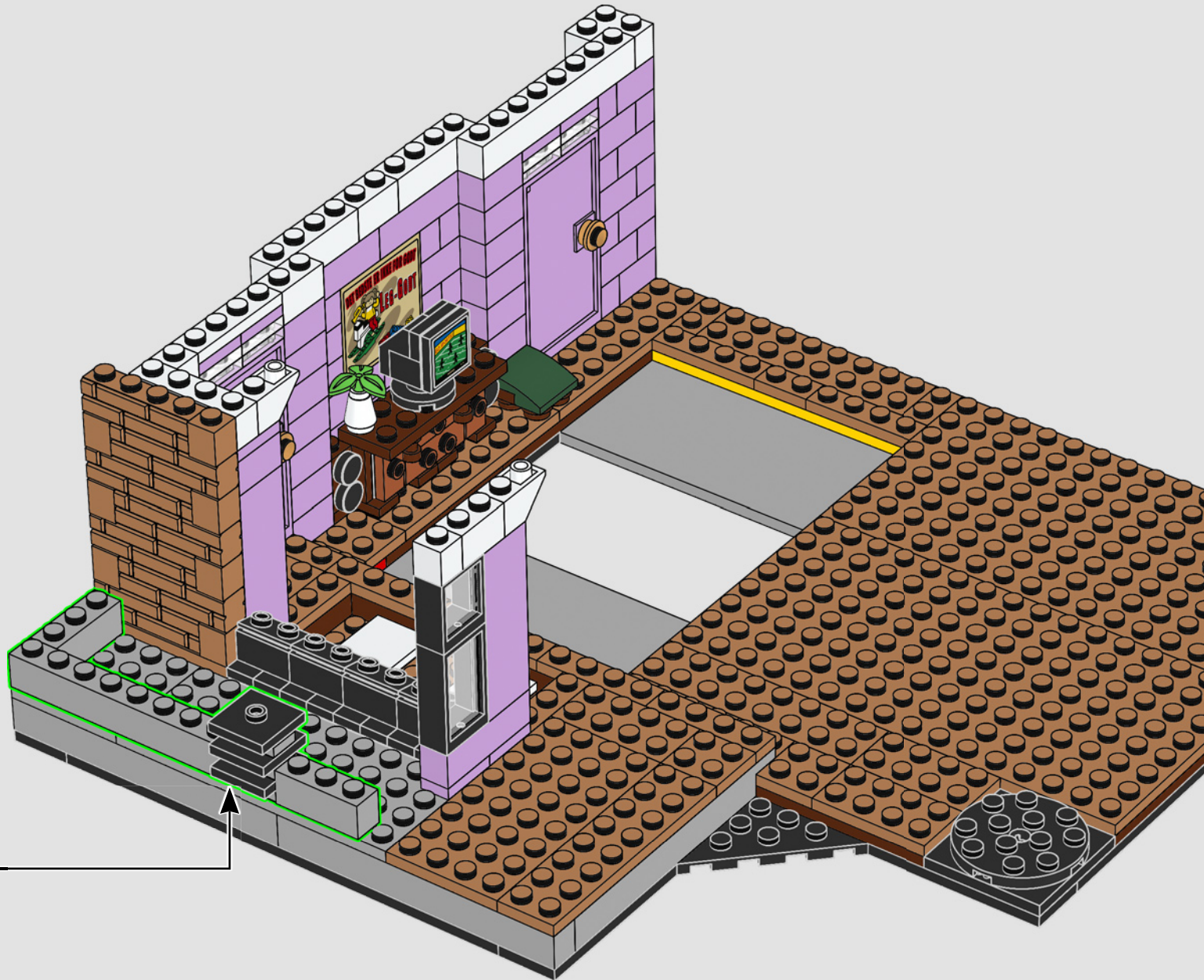
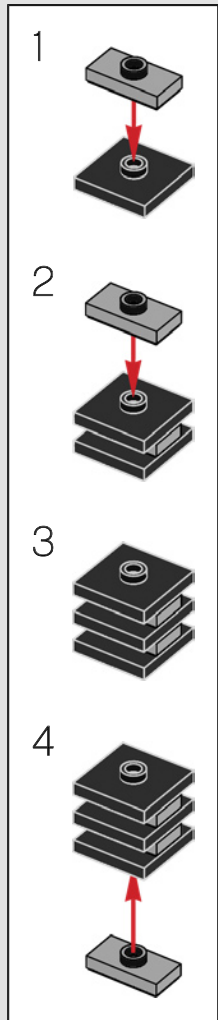

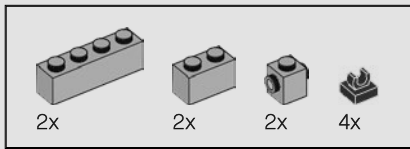

37

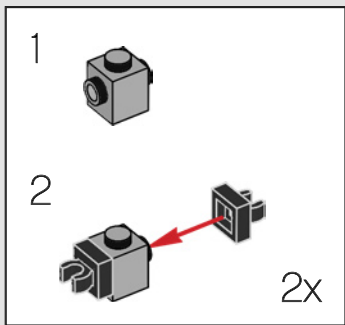
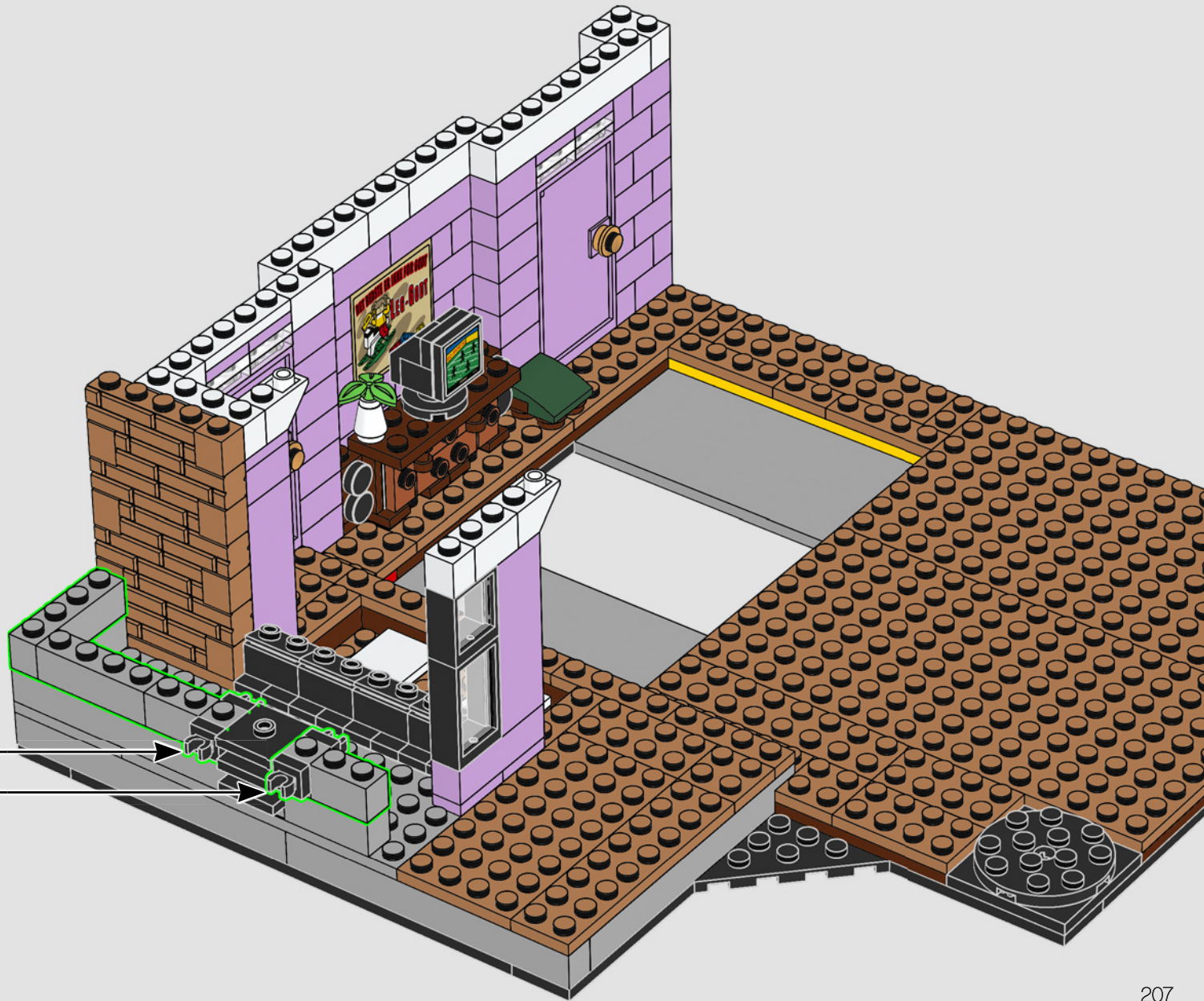



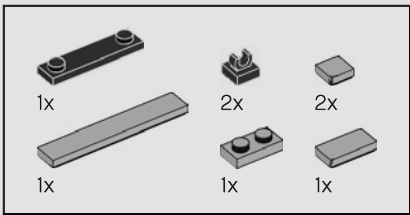

38

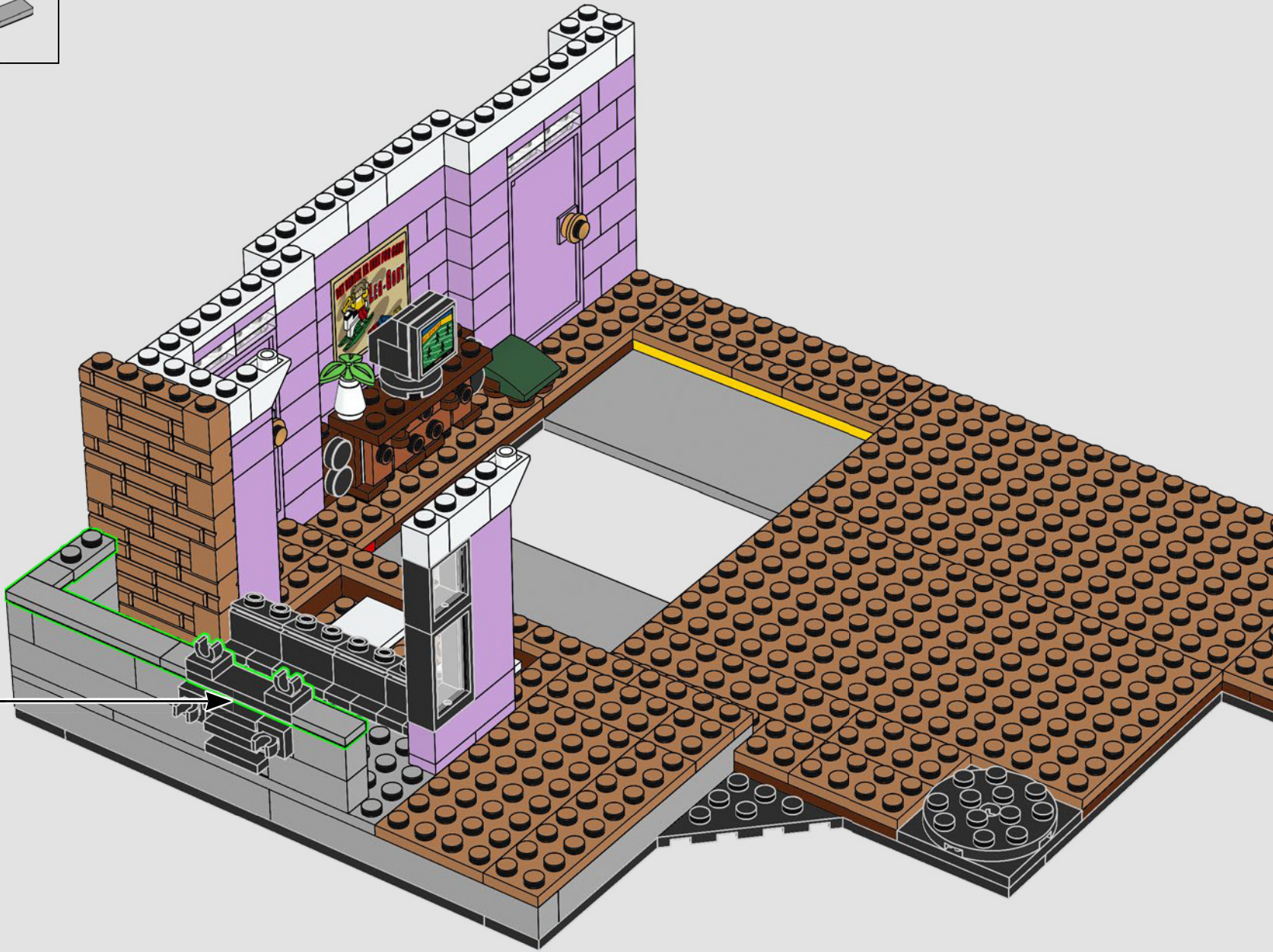
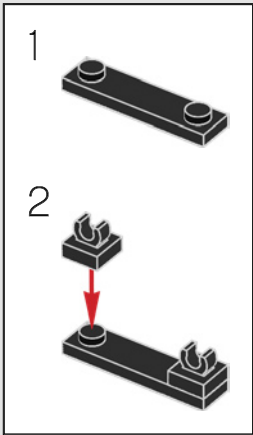





39

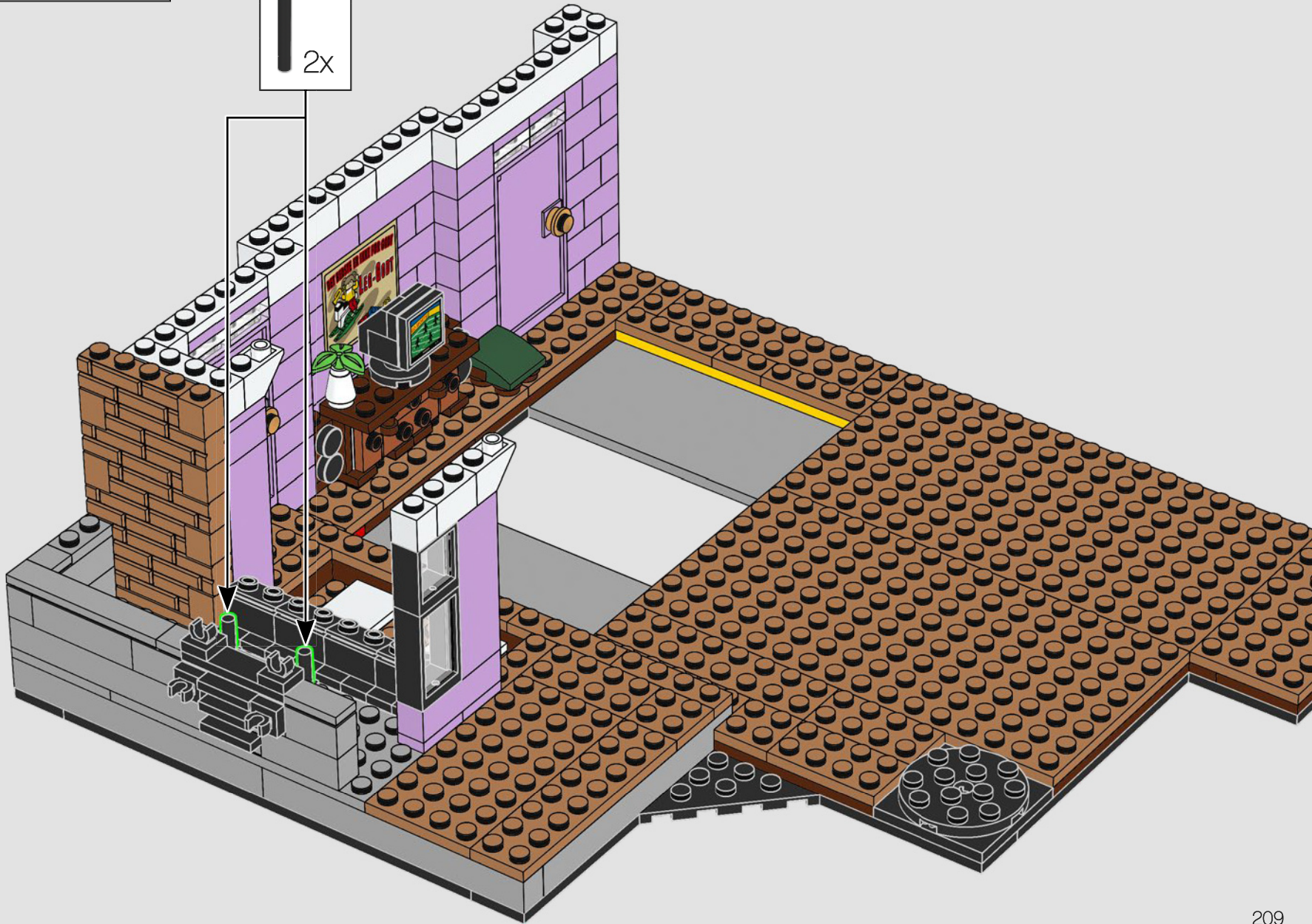
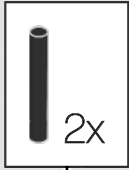





40

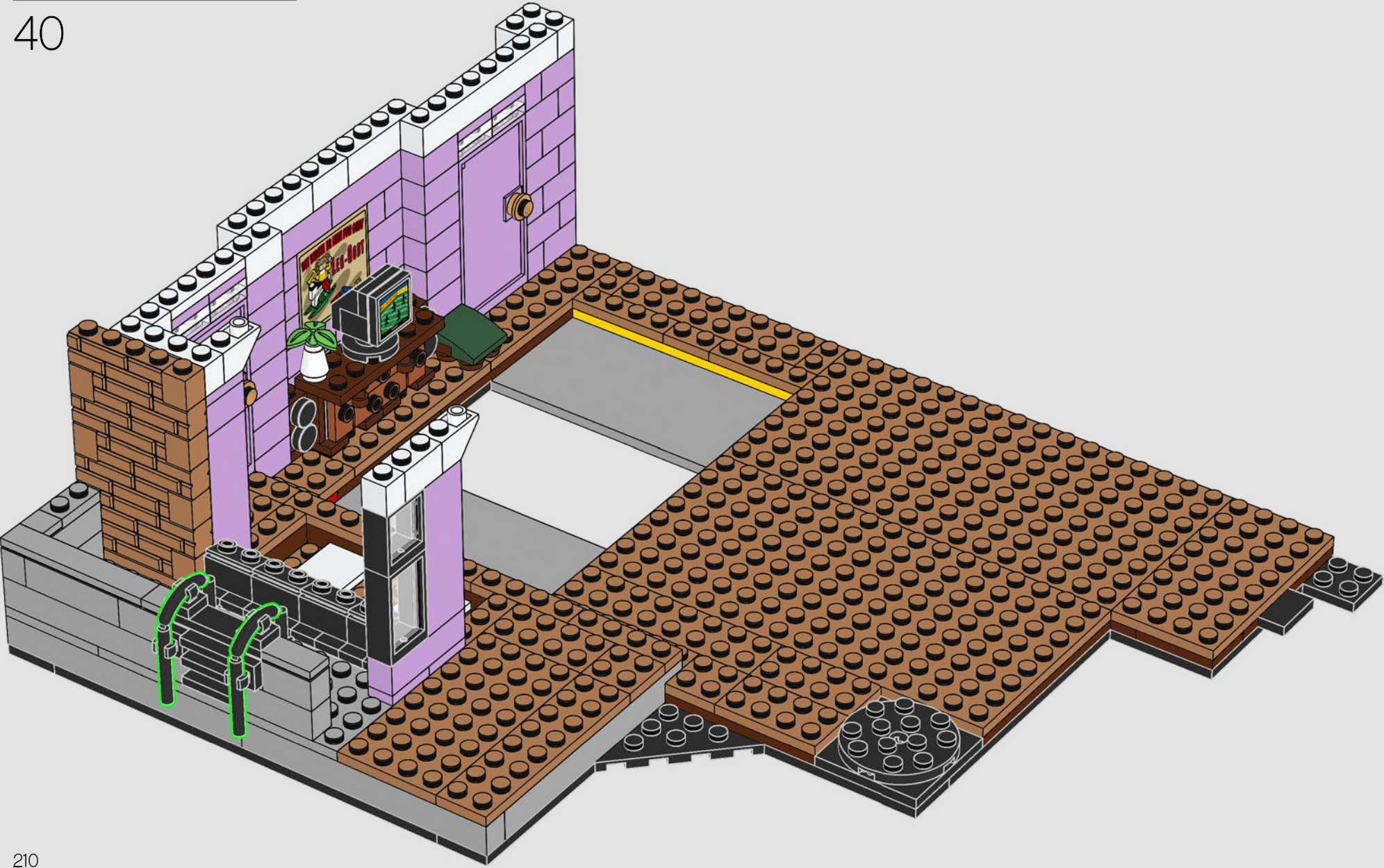



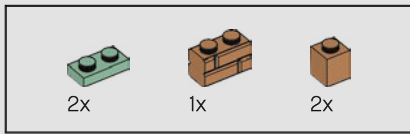

41

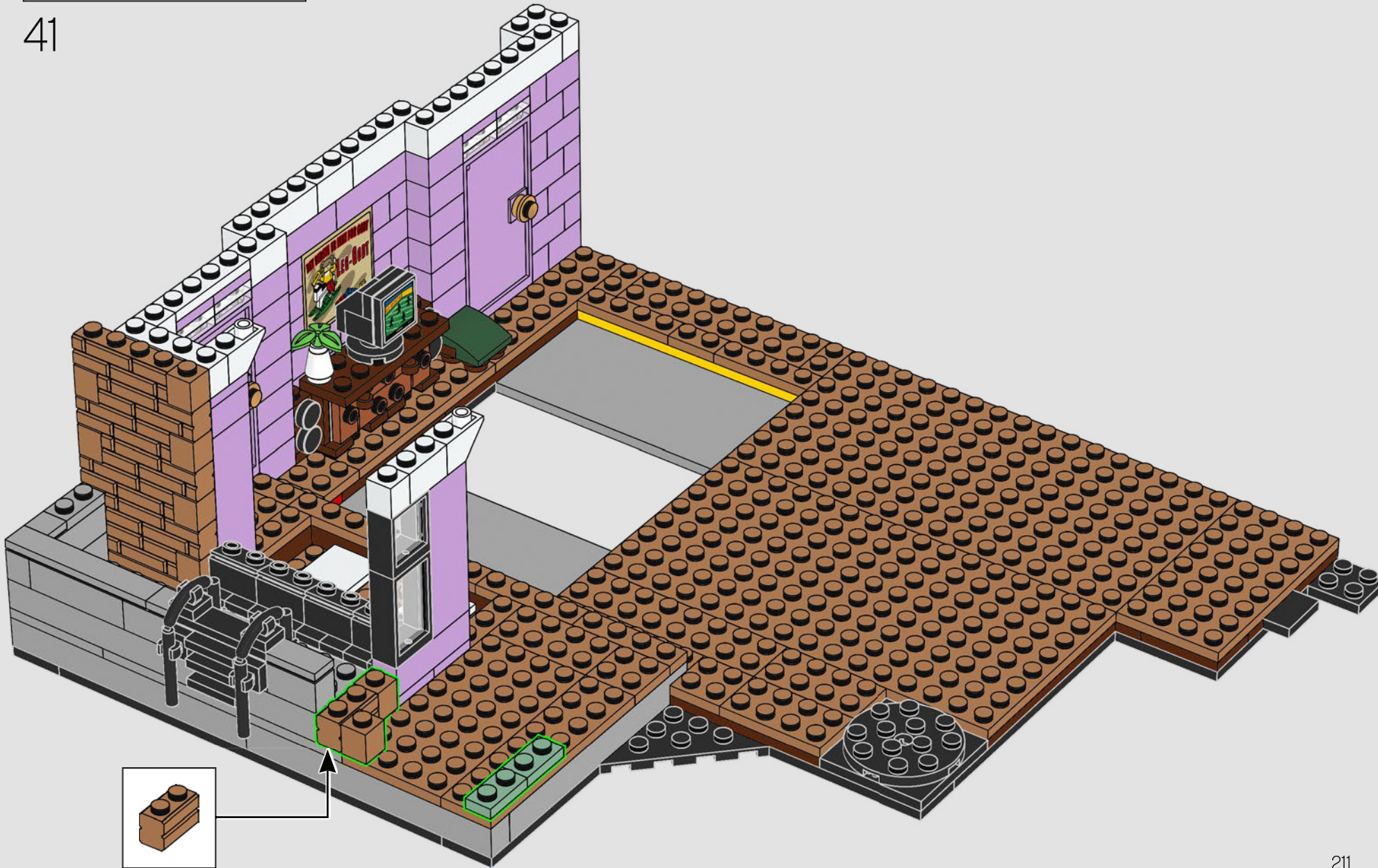



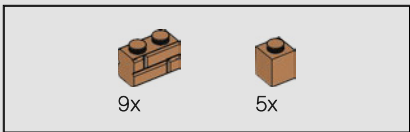

42

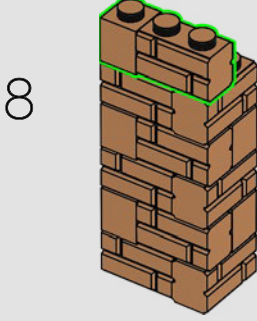
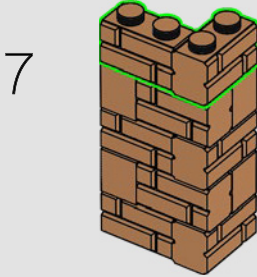
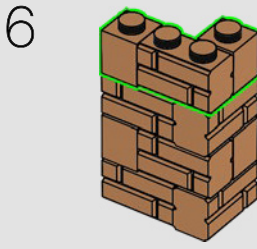
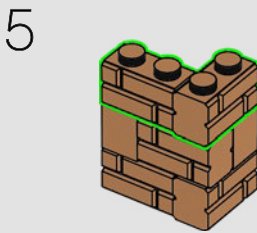
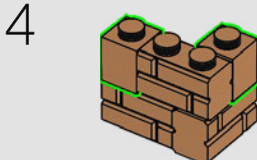
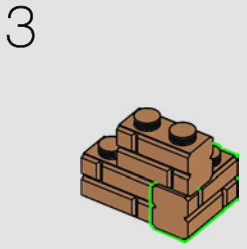
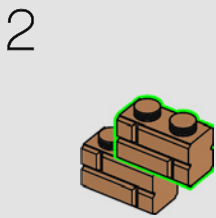

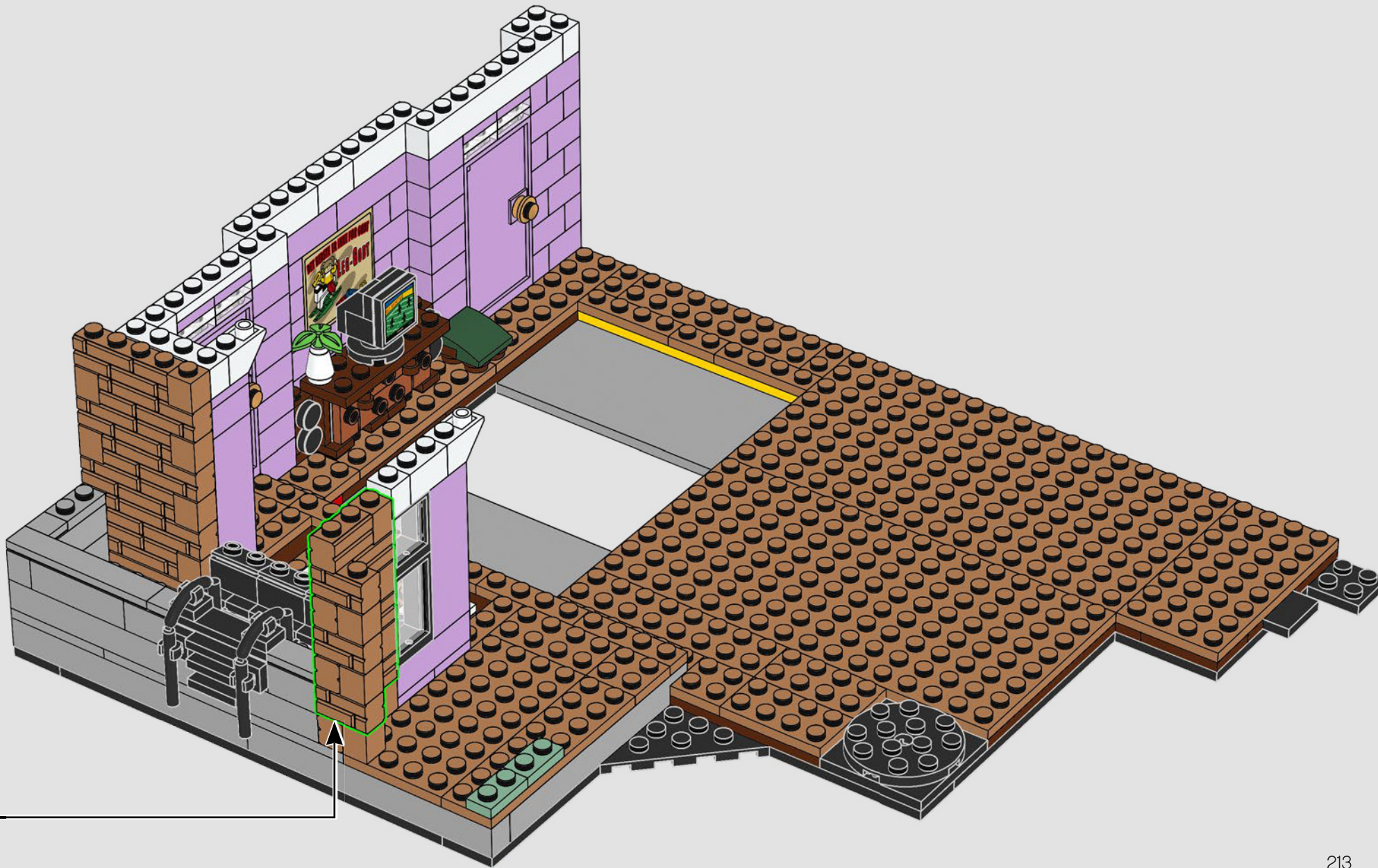



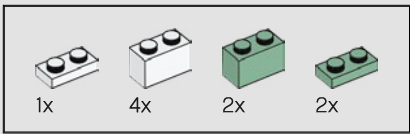

43

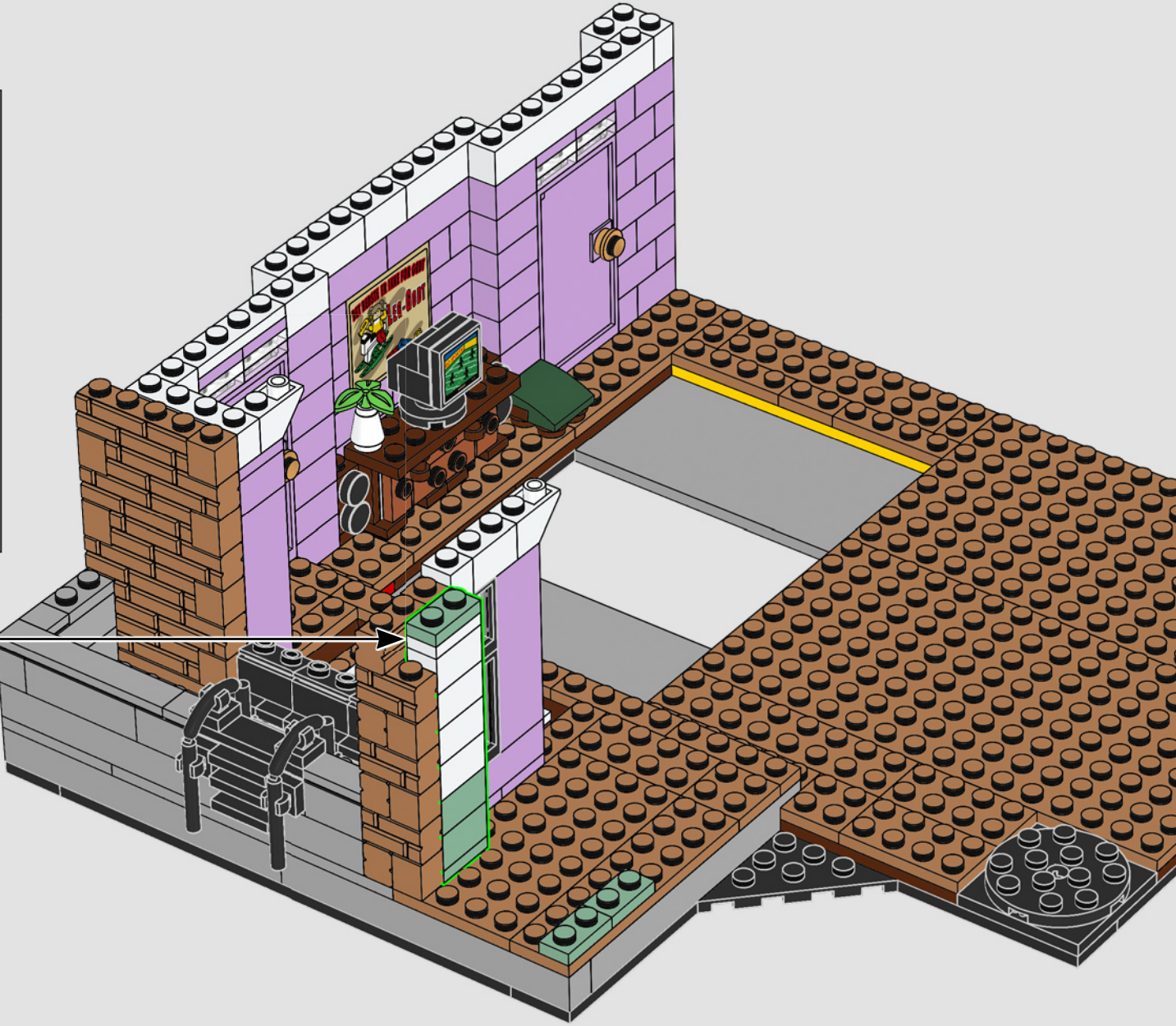
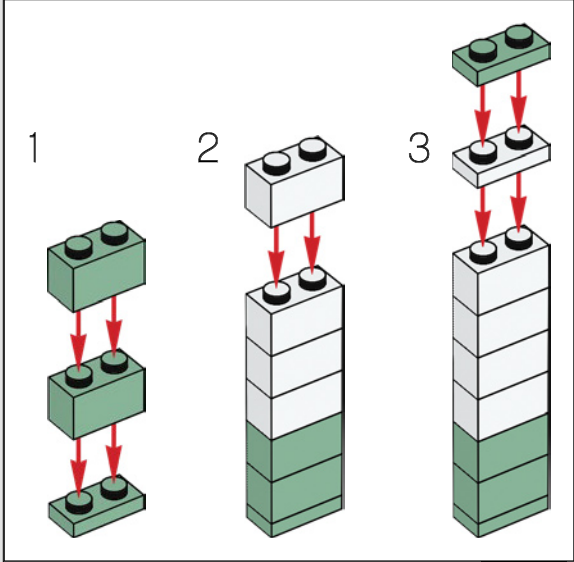



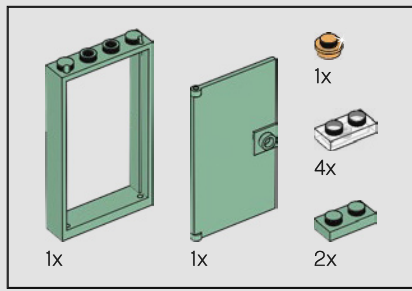

44

1

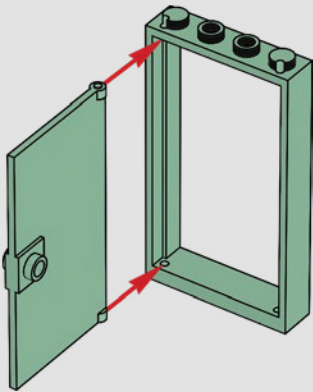

2

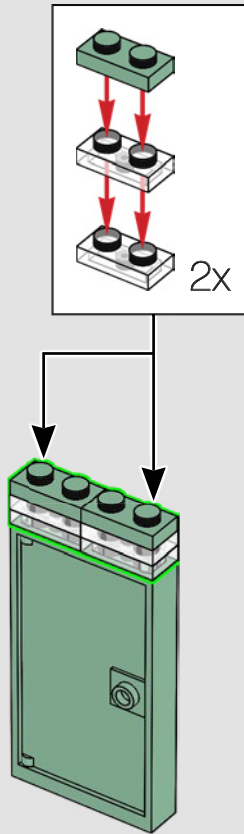

3



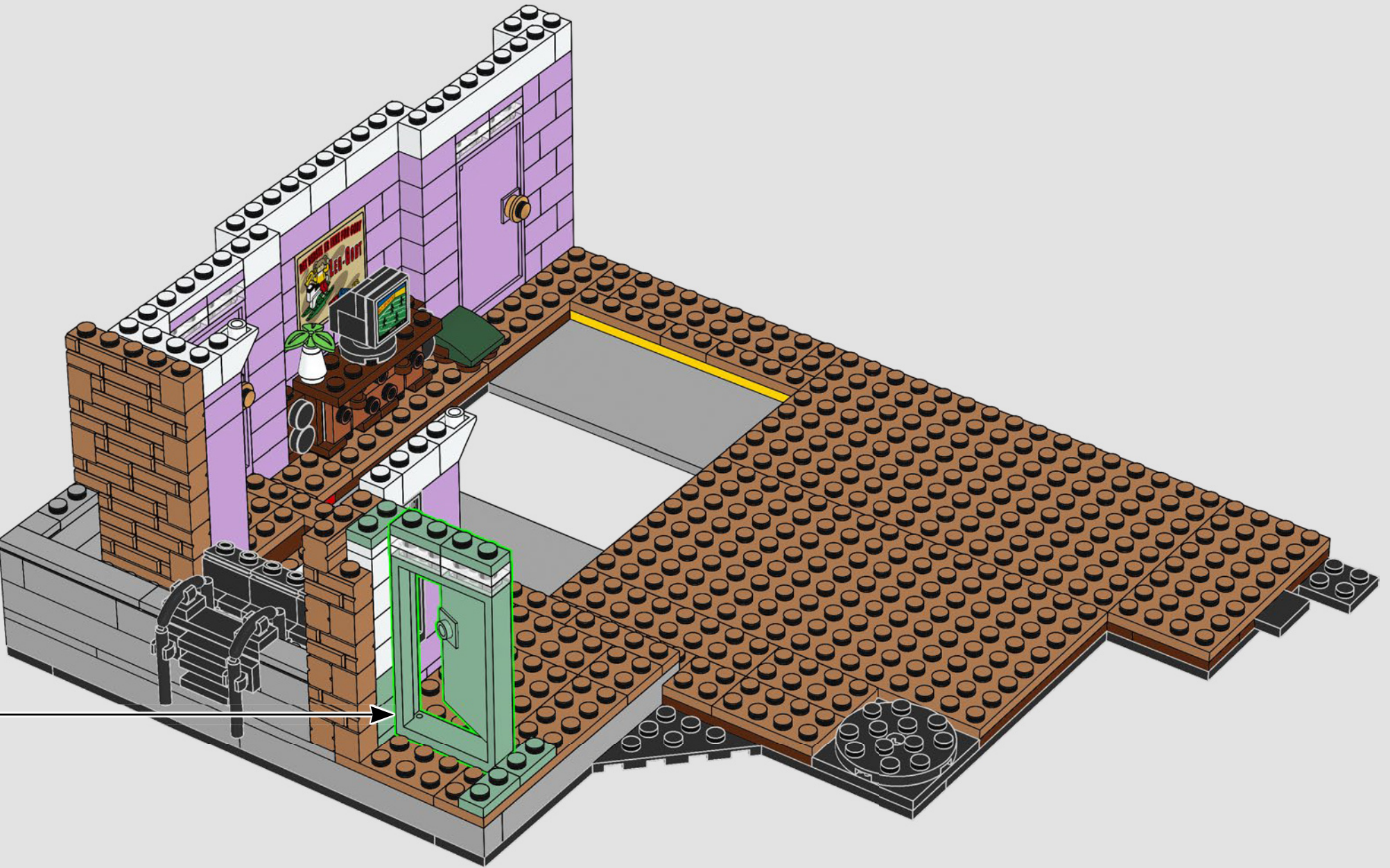



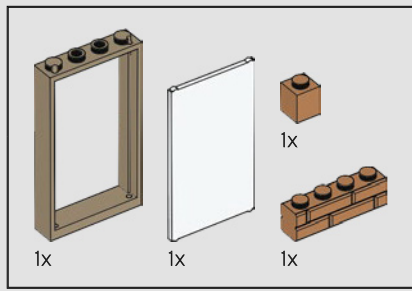

45

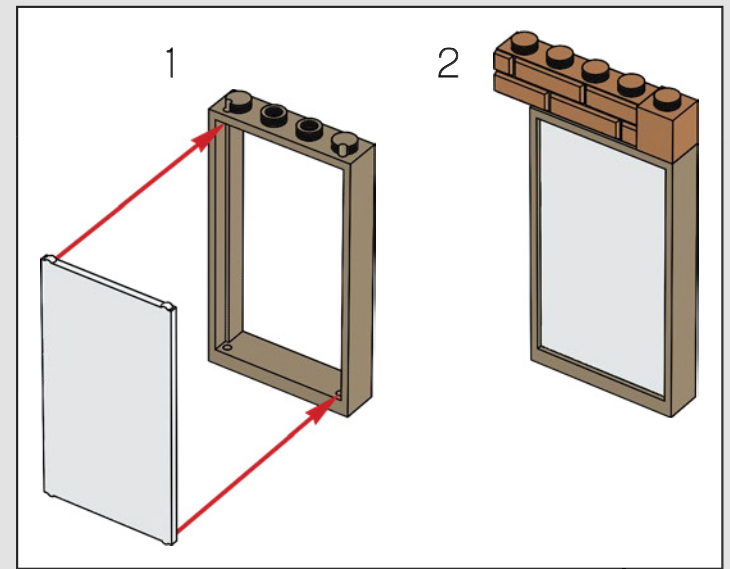
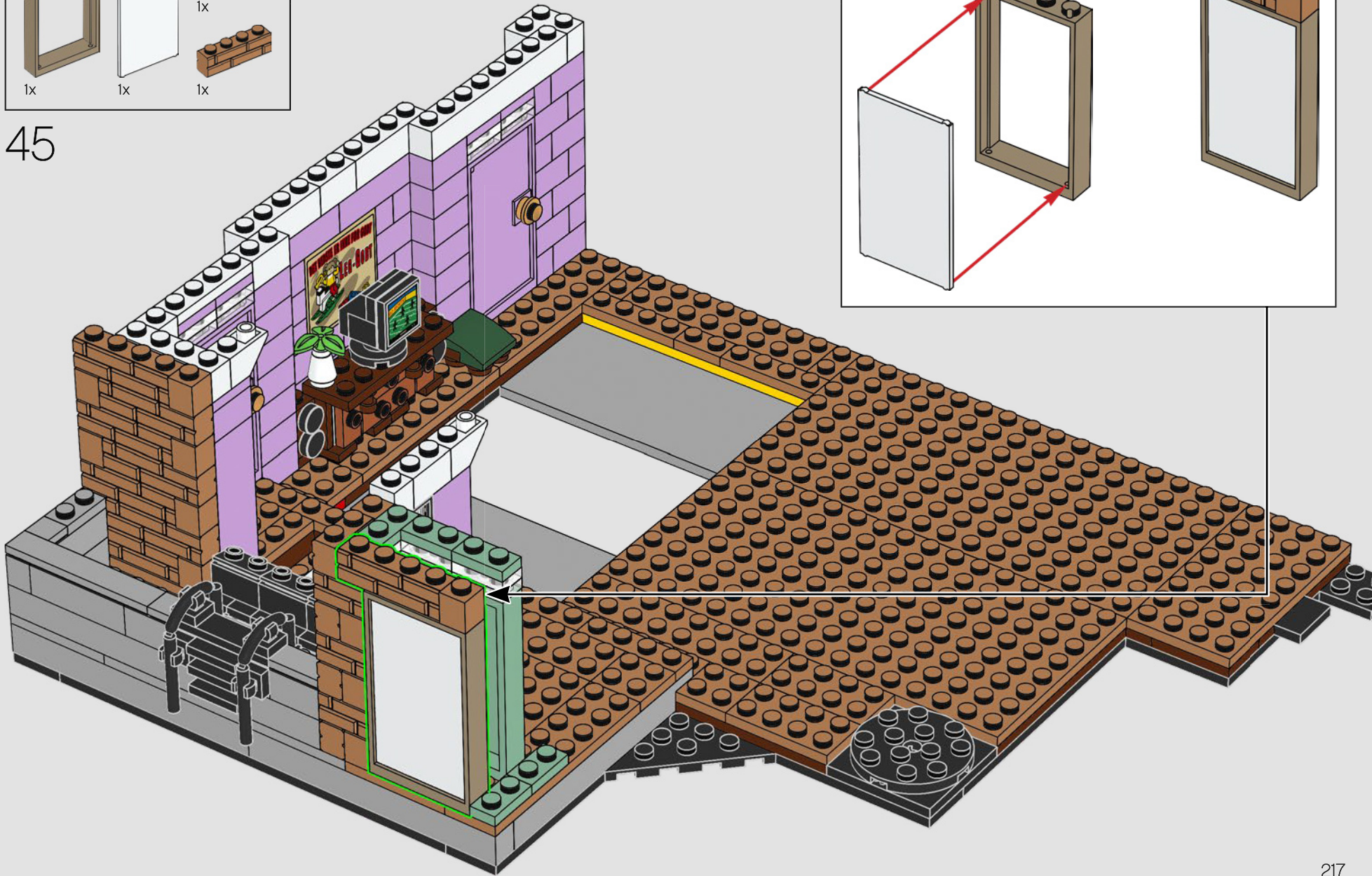



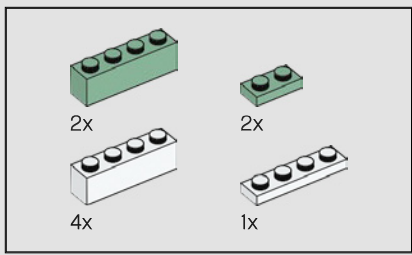

46

1

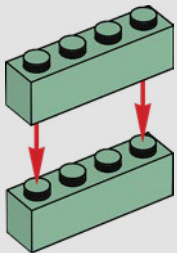

2

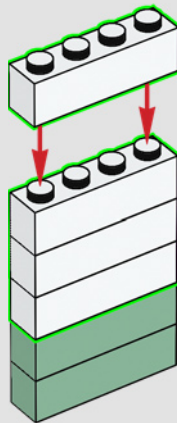

3

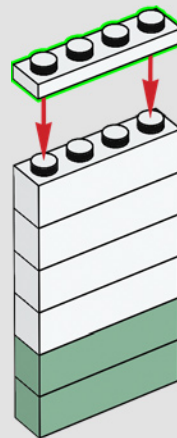

4

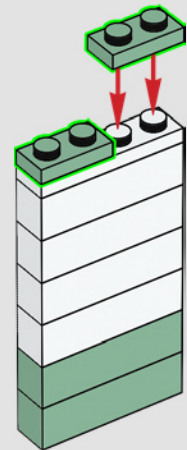

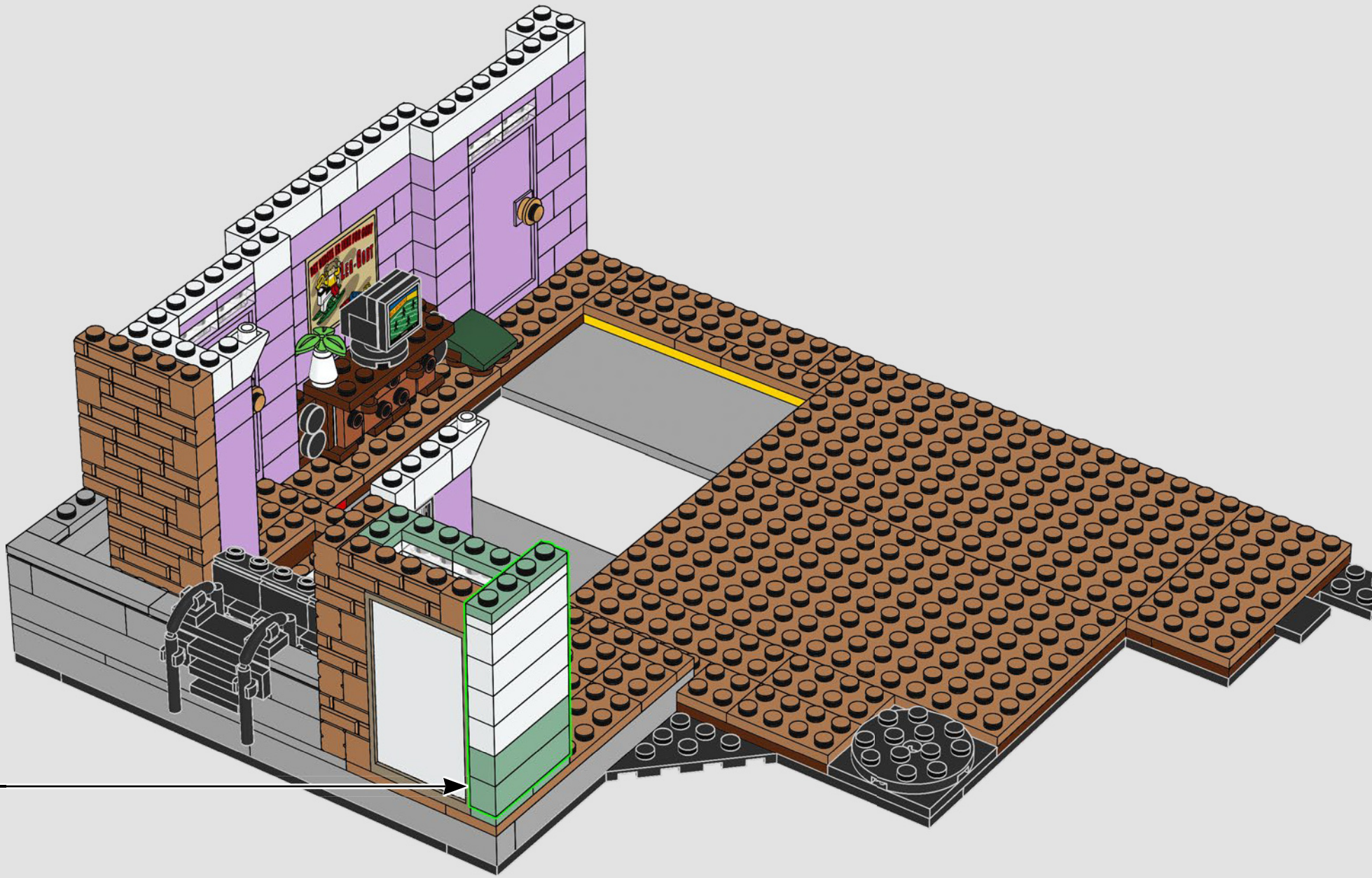



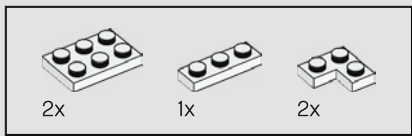

47

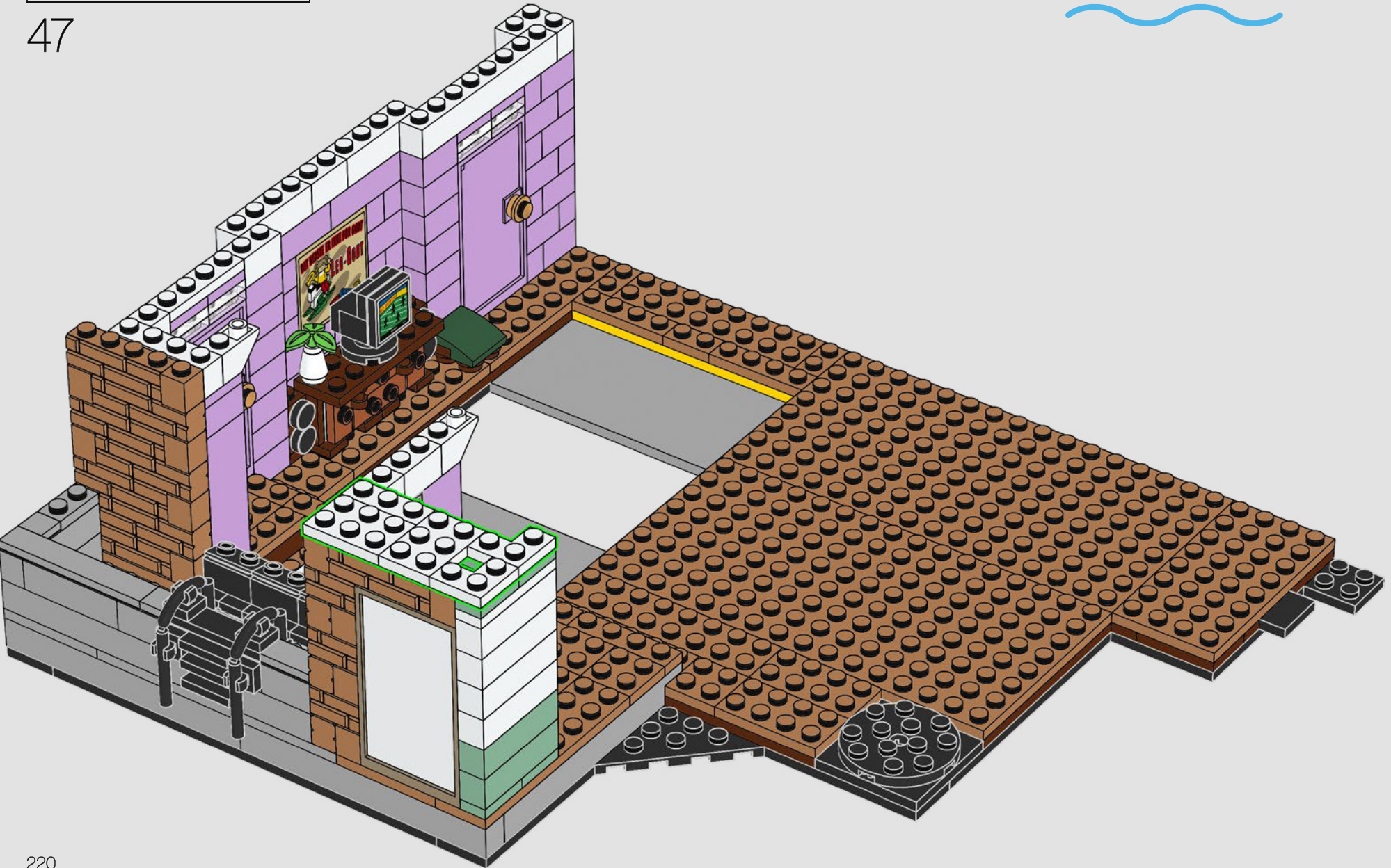

El gato del balcón es el que atacó a Ross cuando estaba a punto de besar a Rachel.





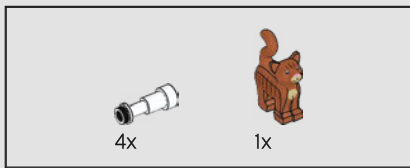

48

El "artilugio punzante" es el que usaron con su vecino del edificio de enfrente cuando pensaron que había muerto.

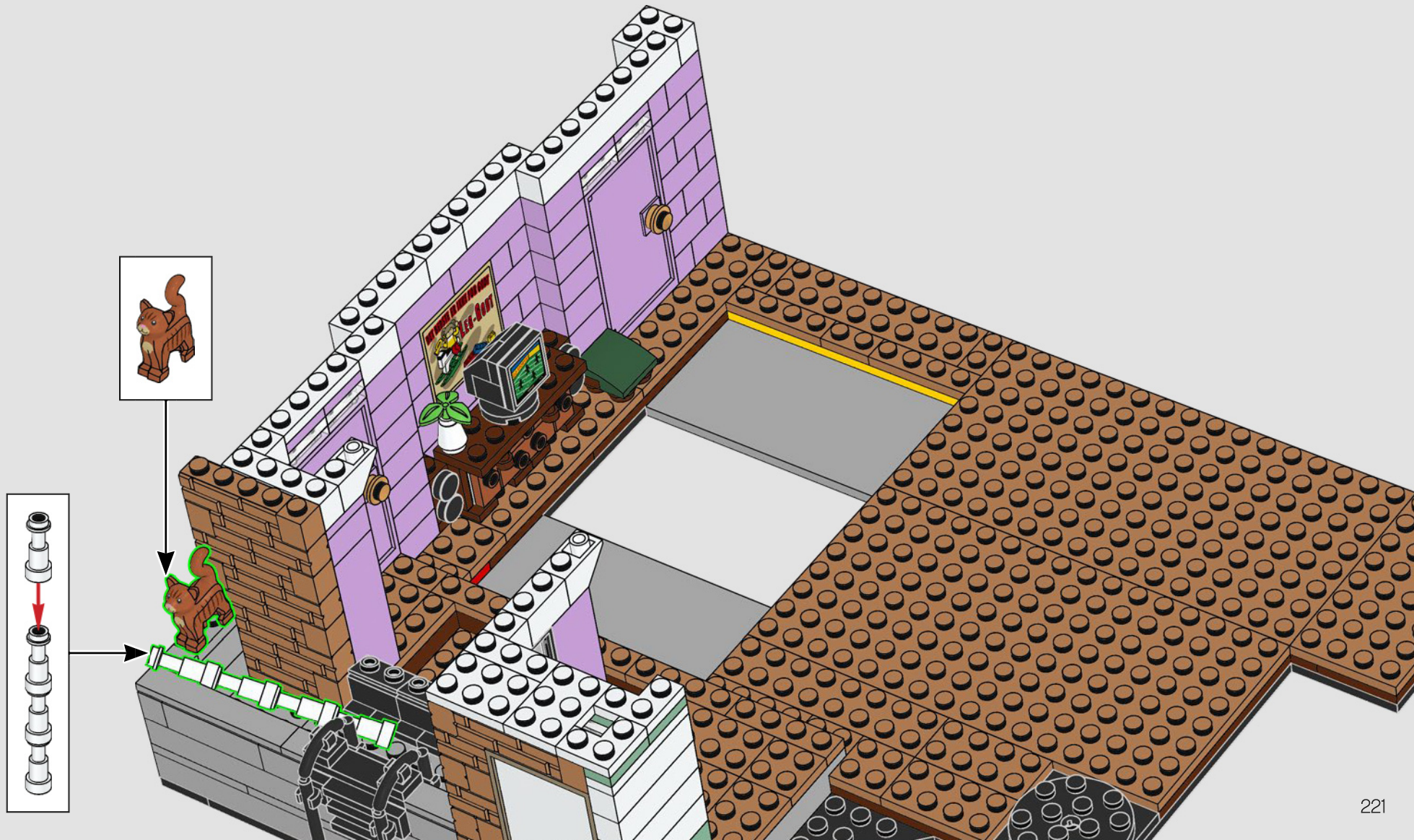

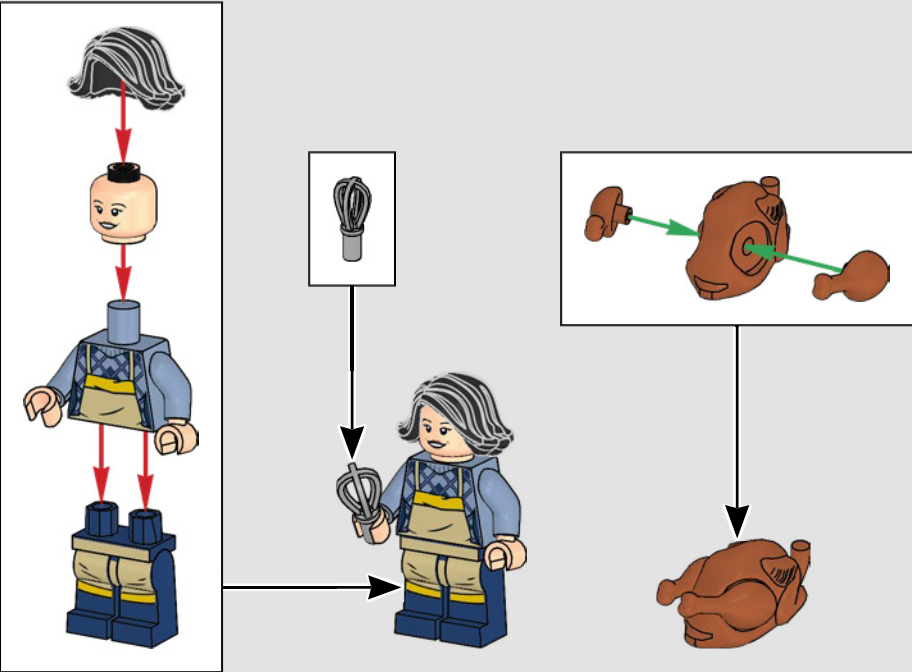
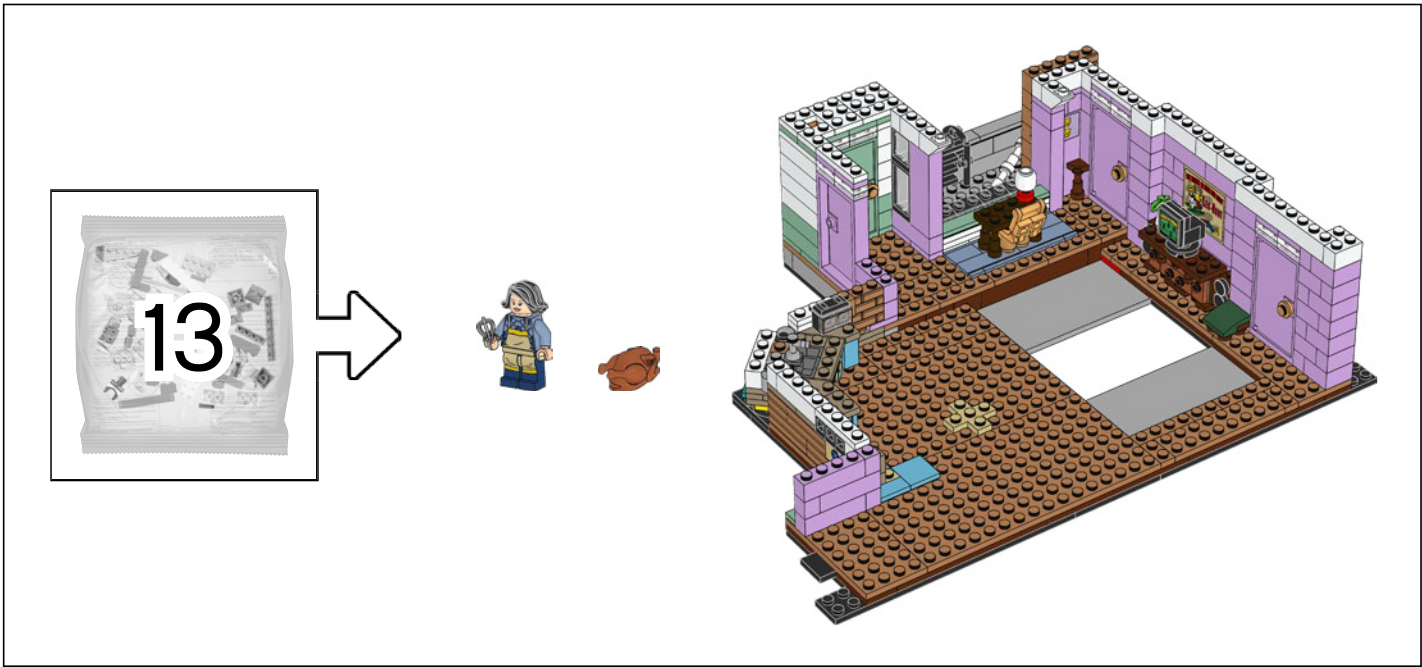

● Hay un pavo en recuerdo del que se puso Monica en la cabeza en el famoso episodio del Día de Acción de Gracias.

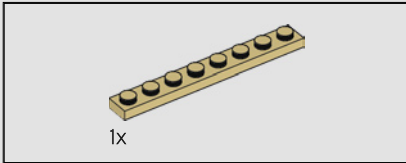
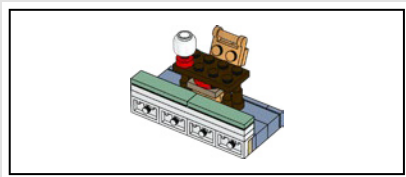

49

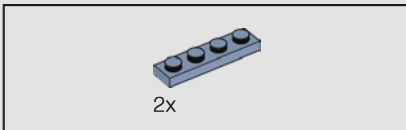
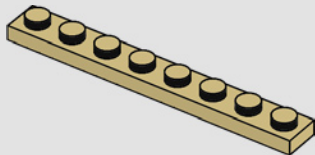

50

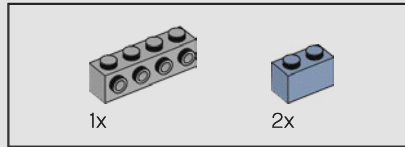
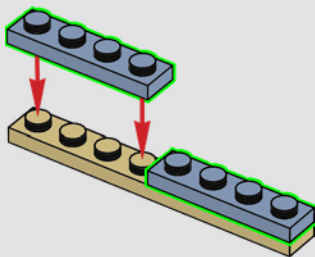

51

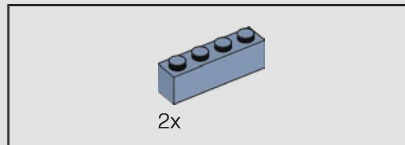
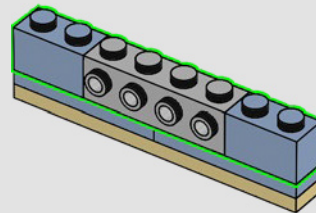

52

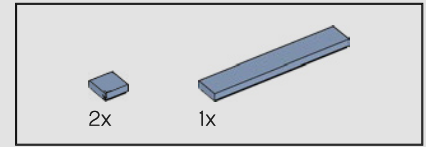
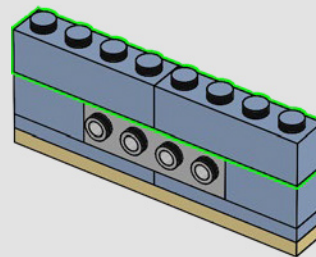

53

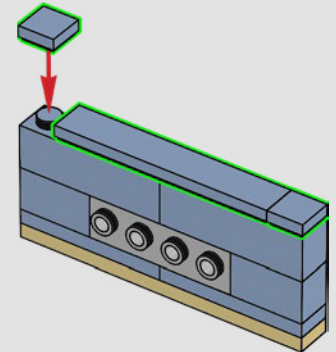

54

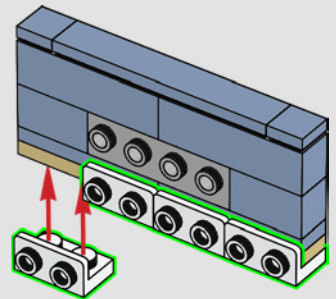



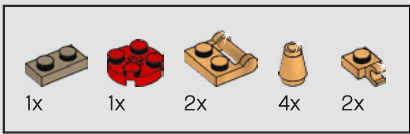

55

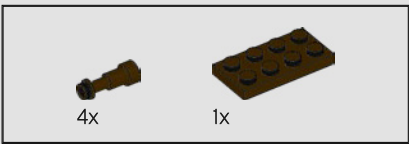
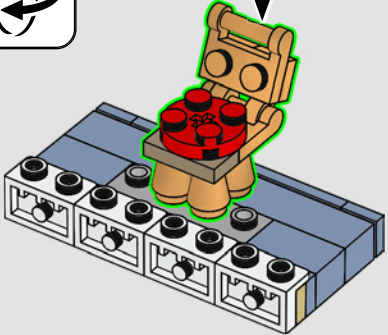
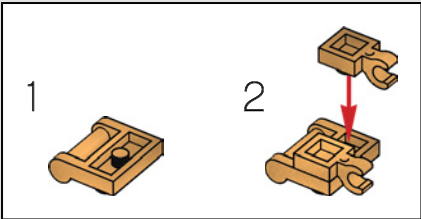
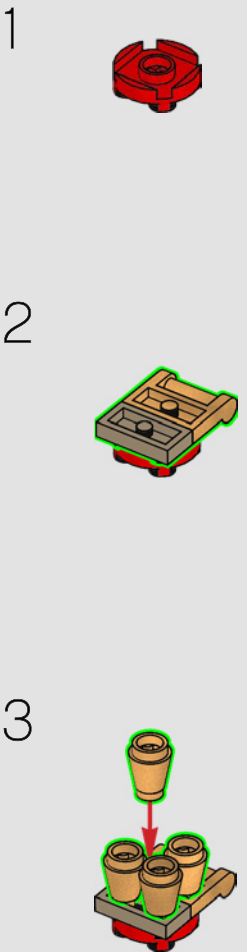

56

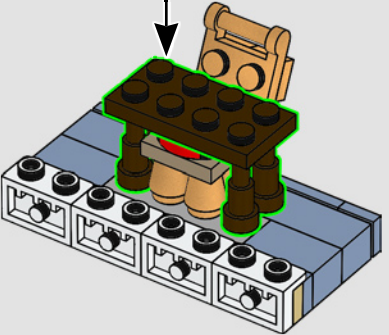
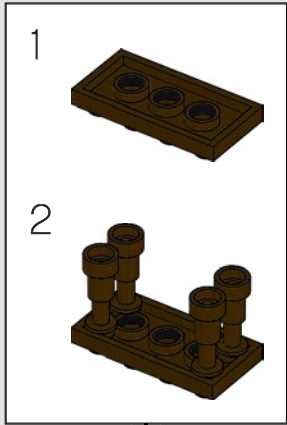

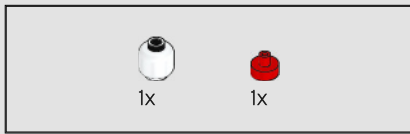

57

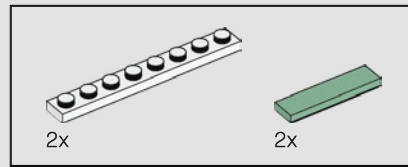
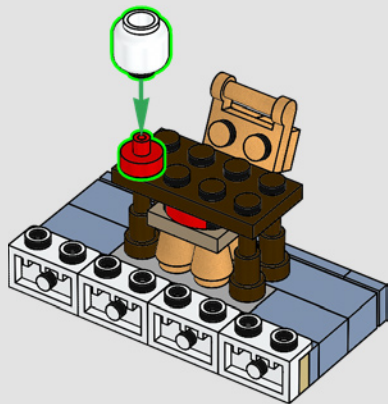

58

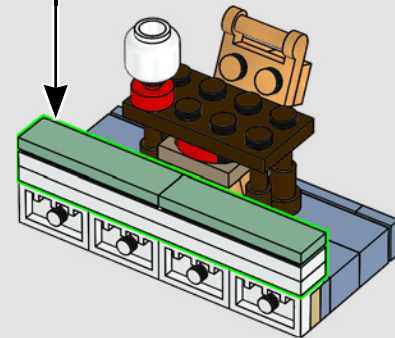
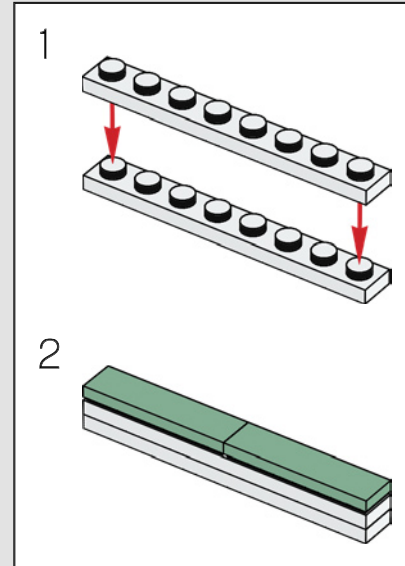



59

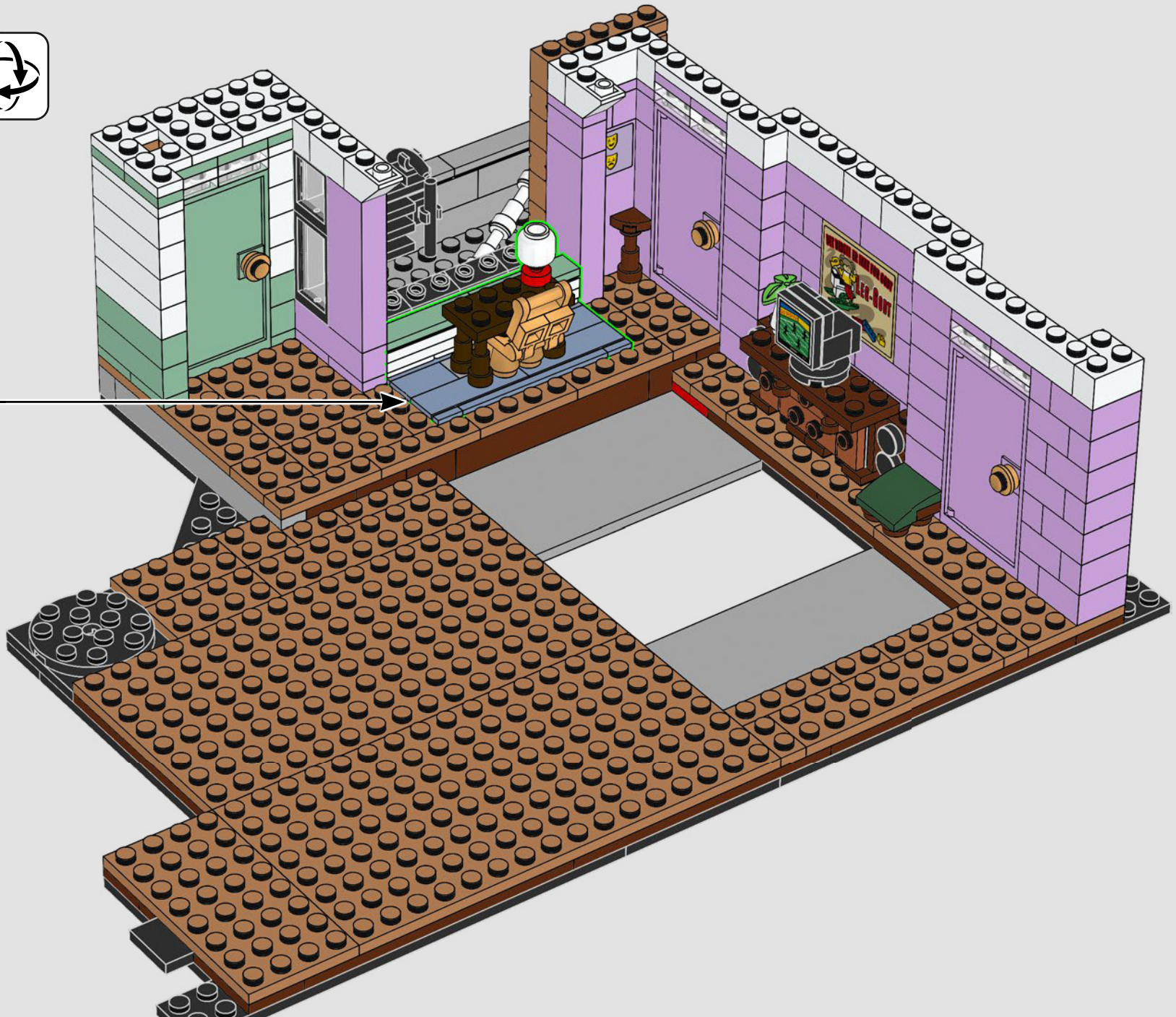



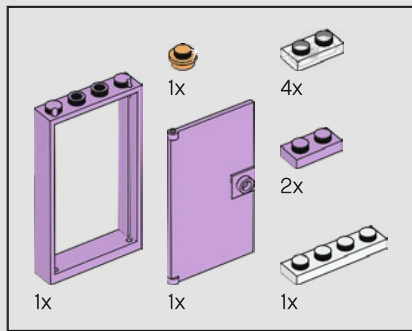

60

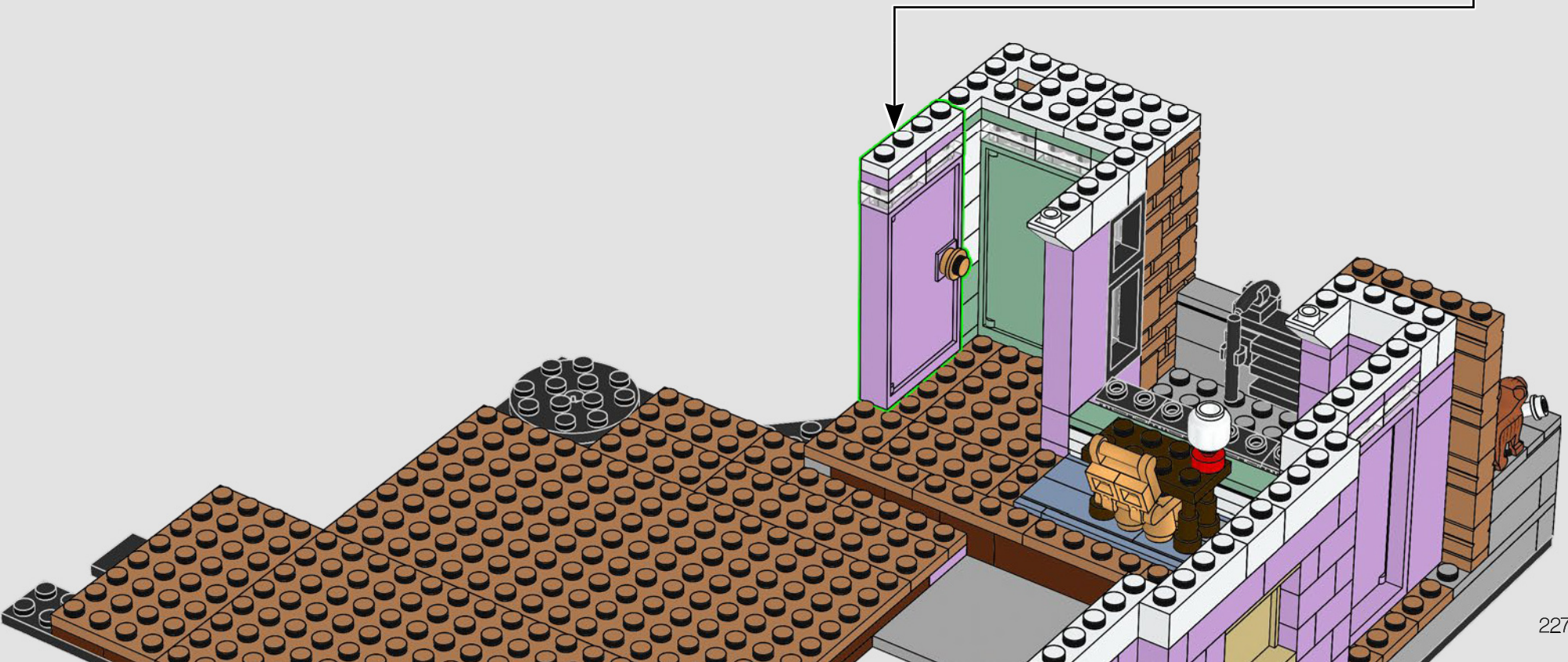
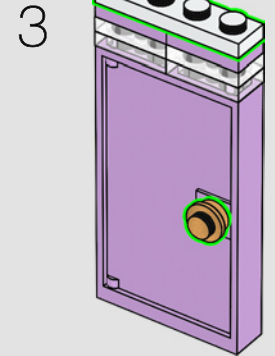
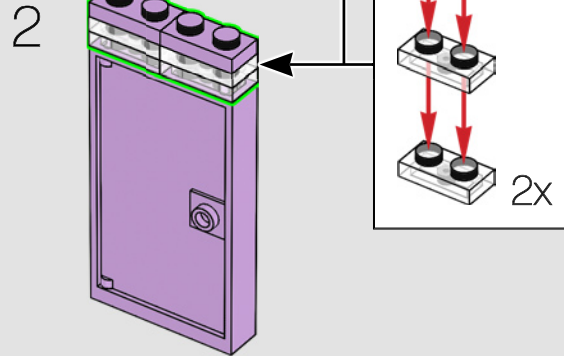
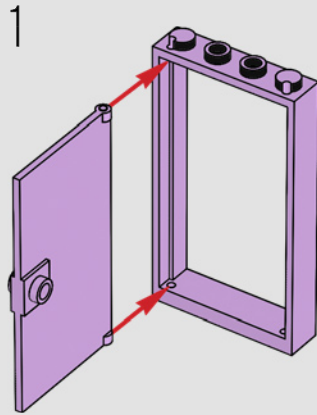



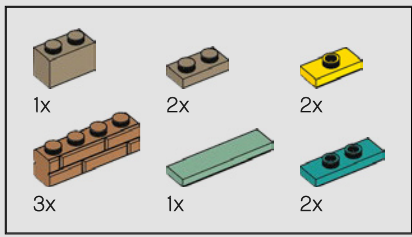

61

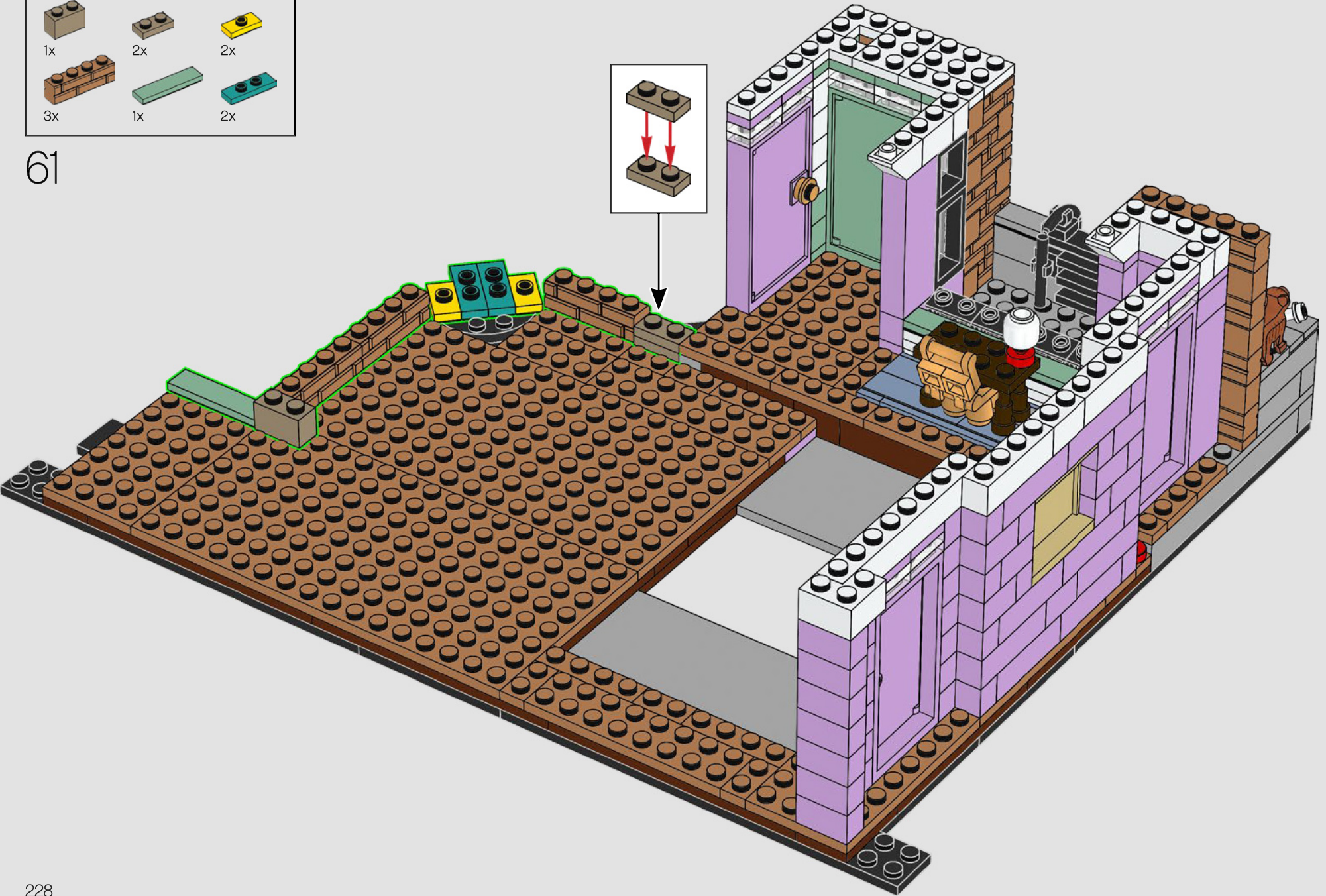
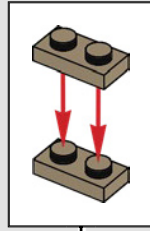



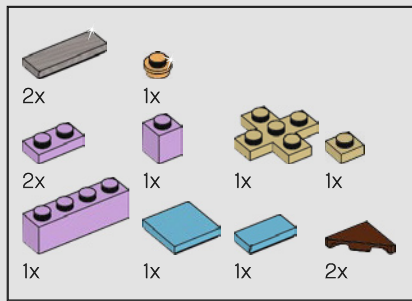

62

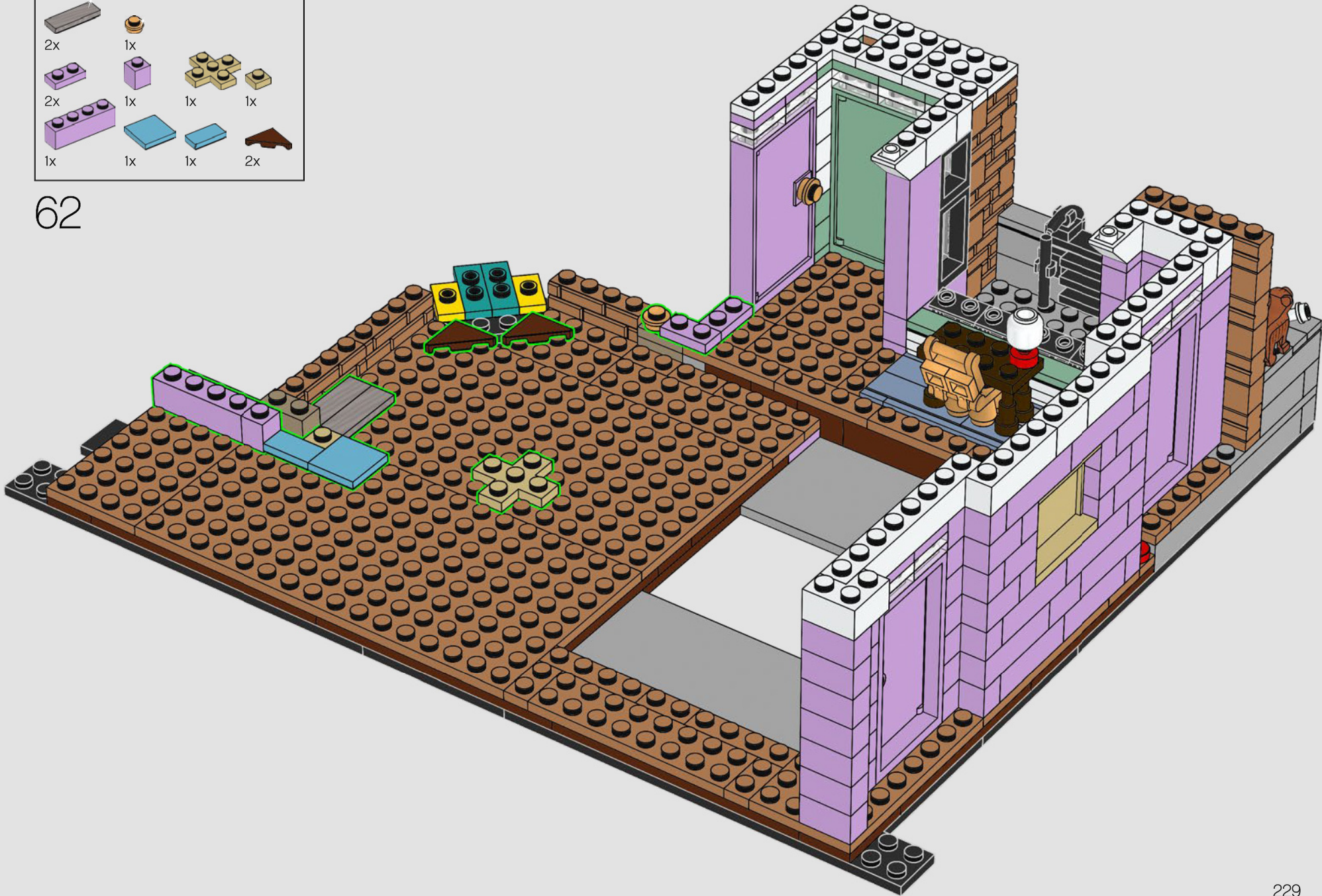



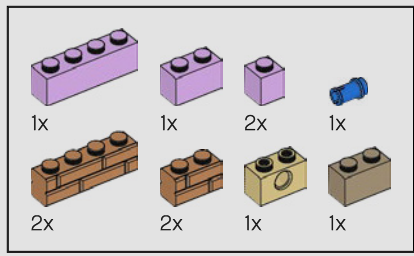

63

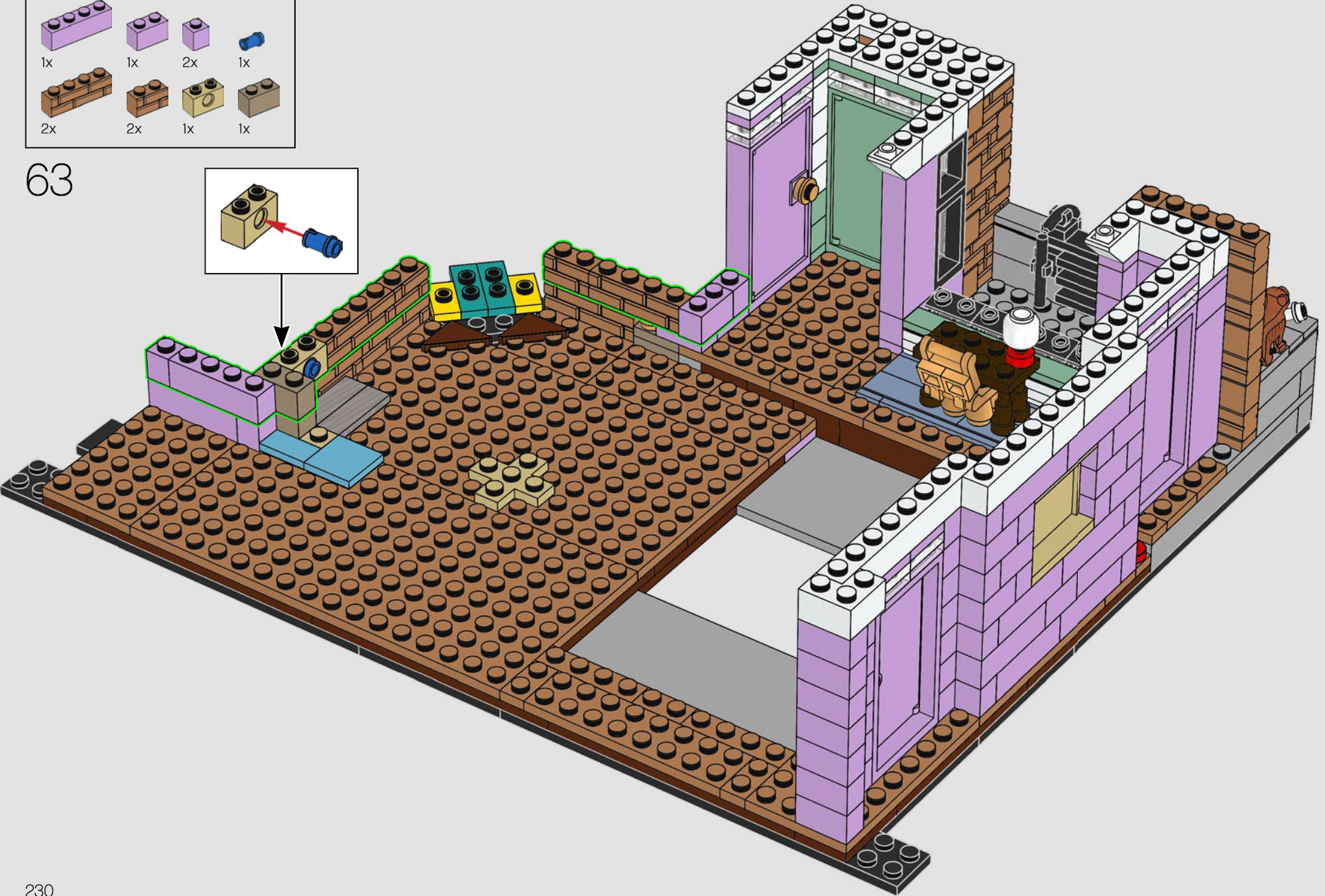
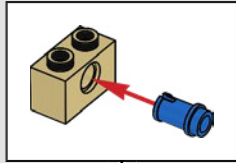



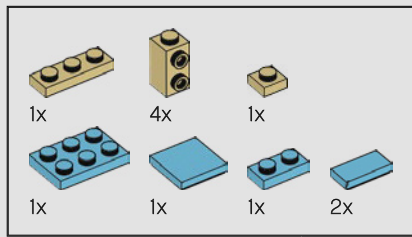

64

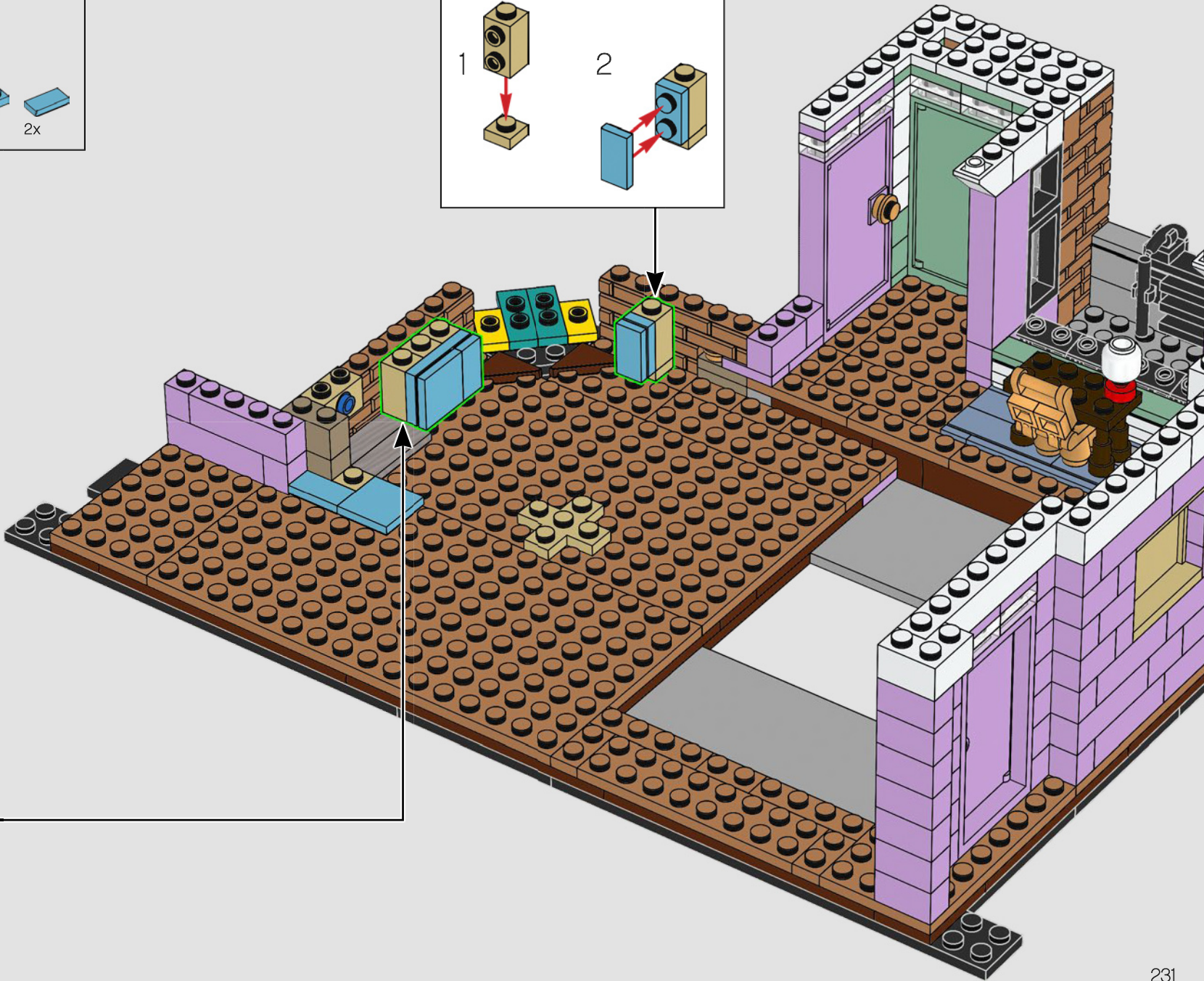
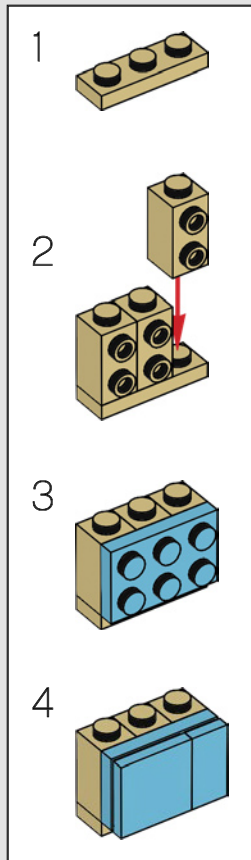
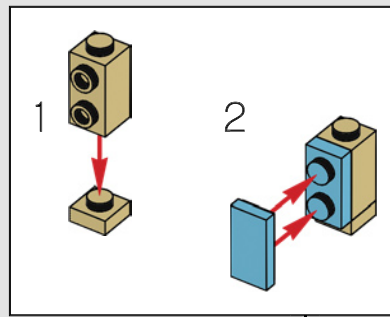

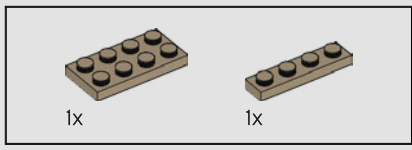

65

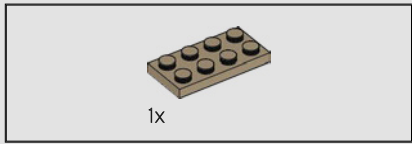
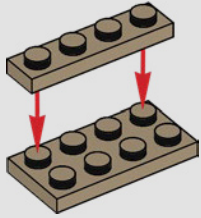

66

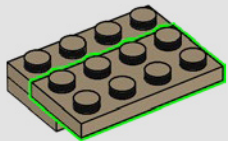

67

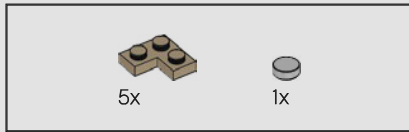
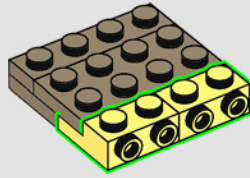

68

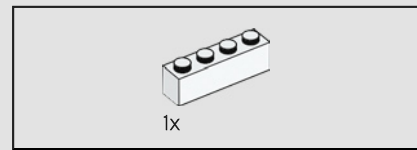
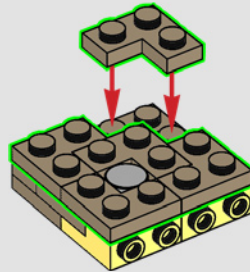

69

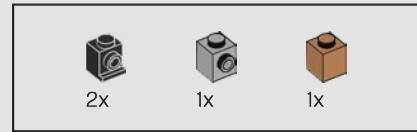
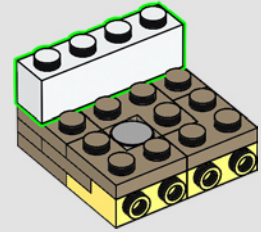

70

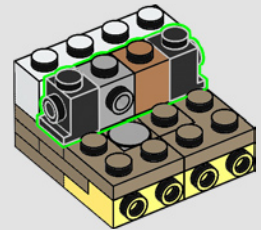





71

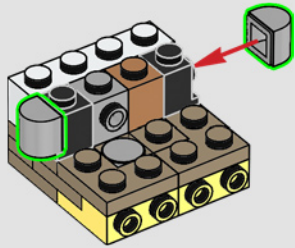

72

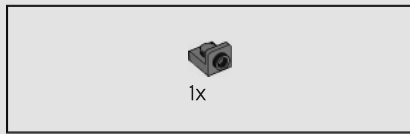
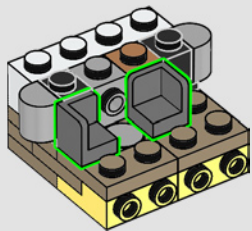

73

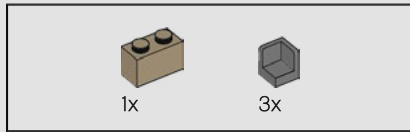
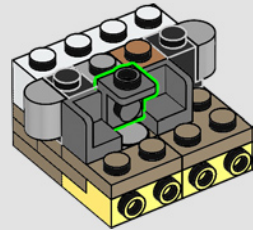

74

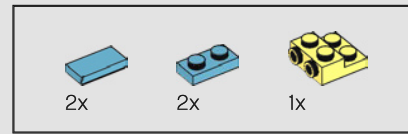
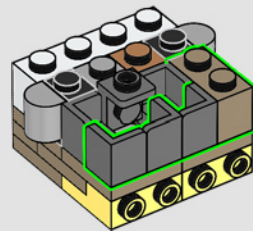

75

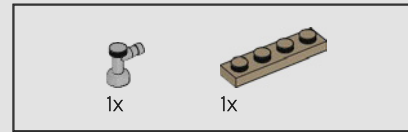
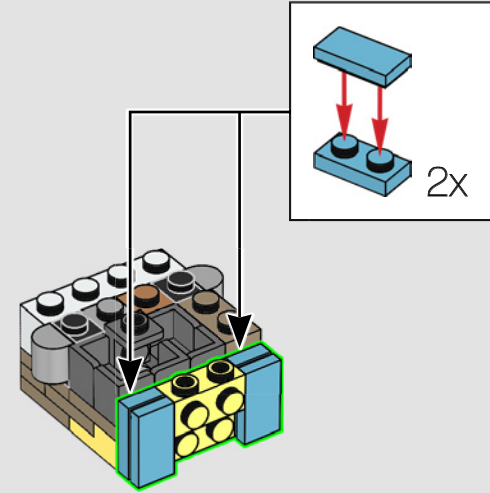

76

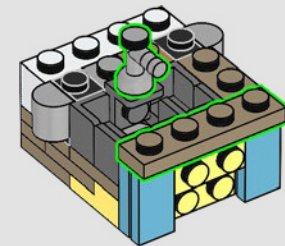

77

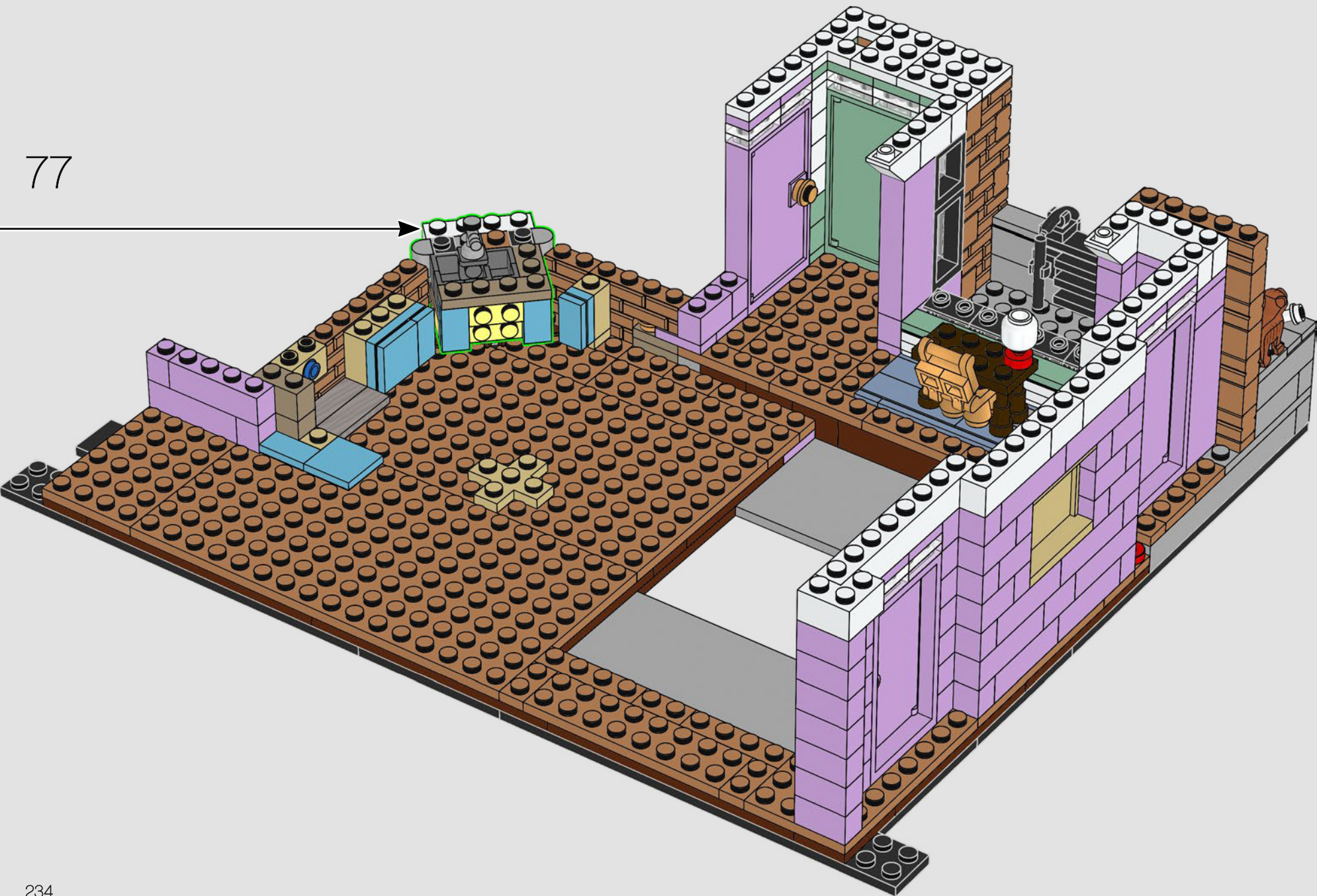



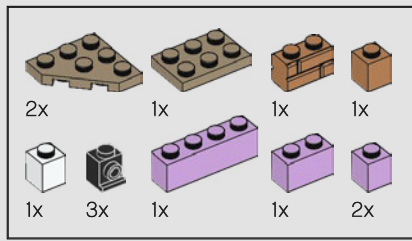

78

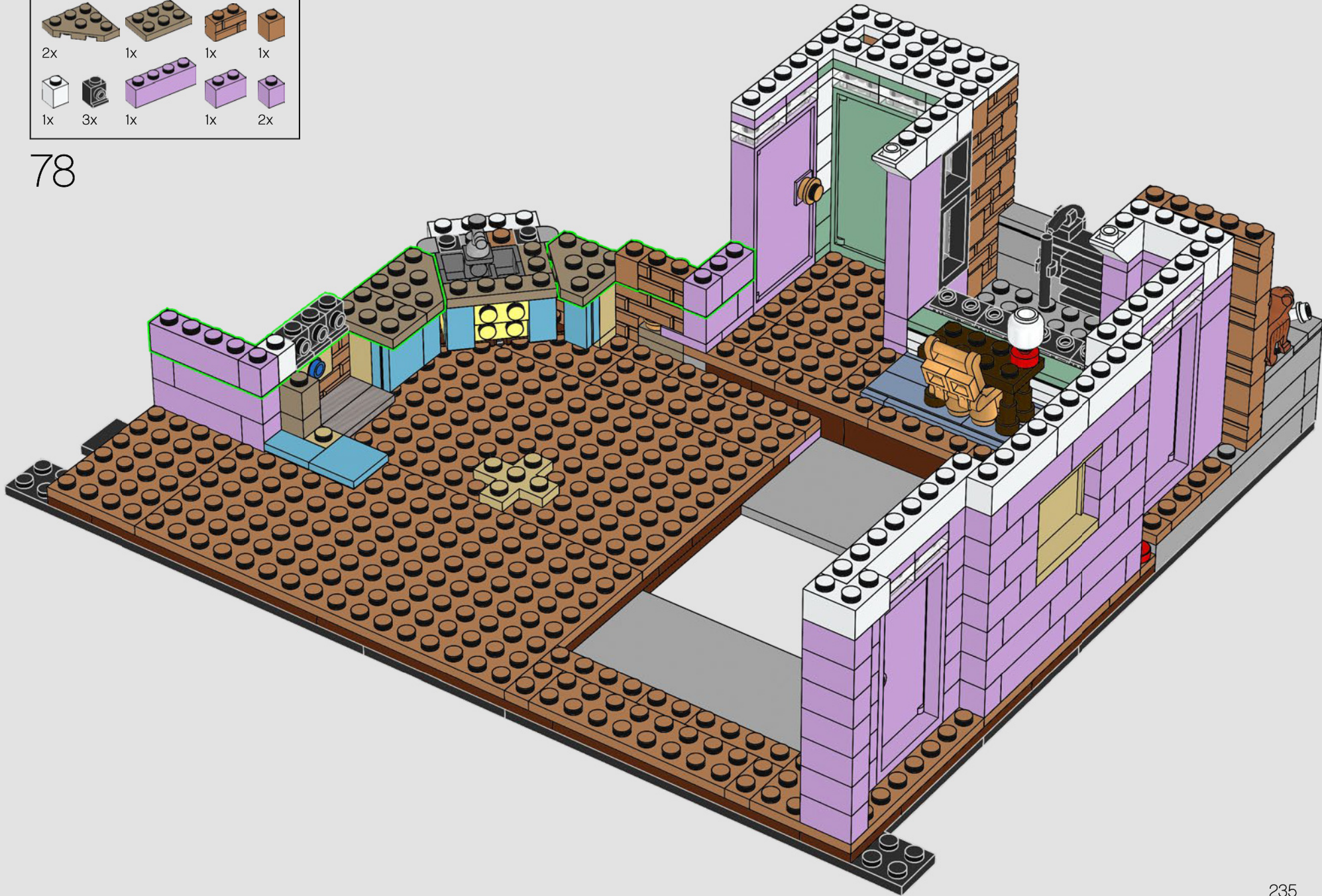



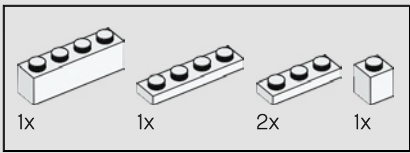

79

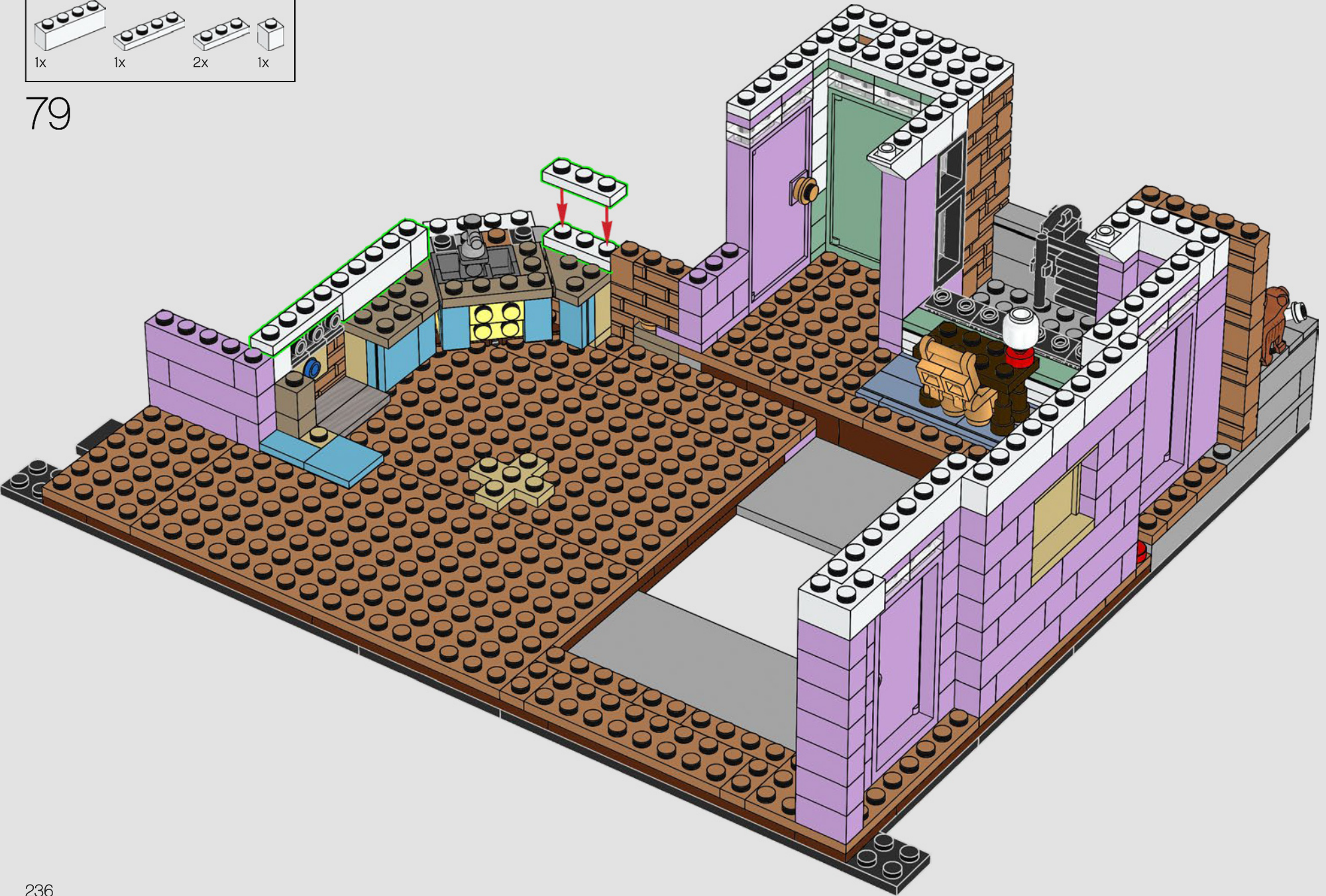



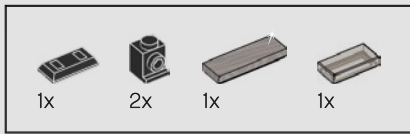

80

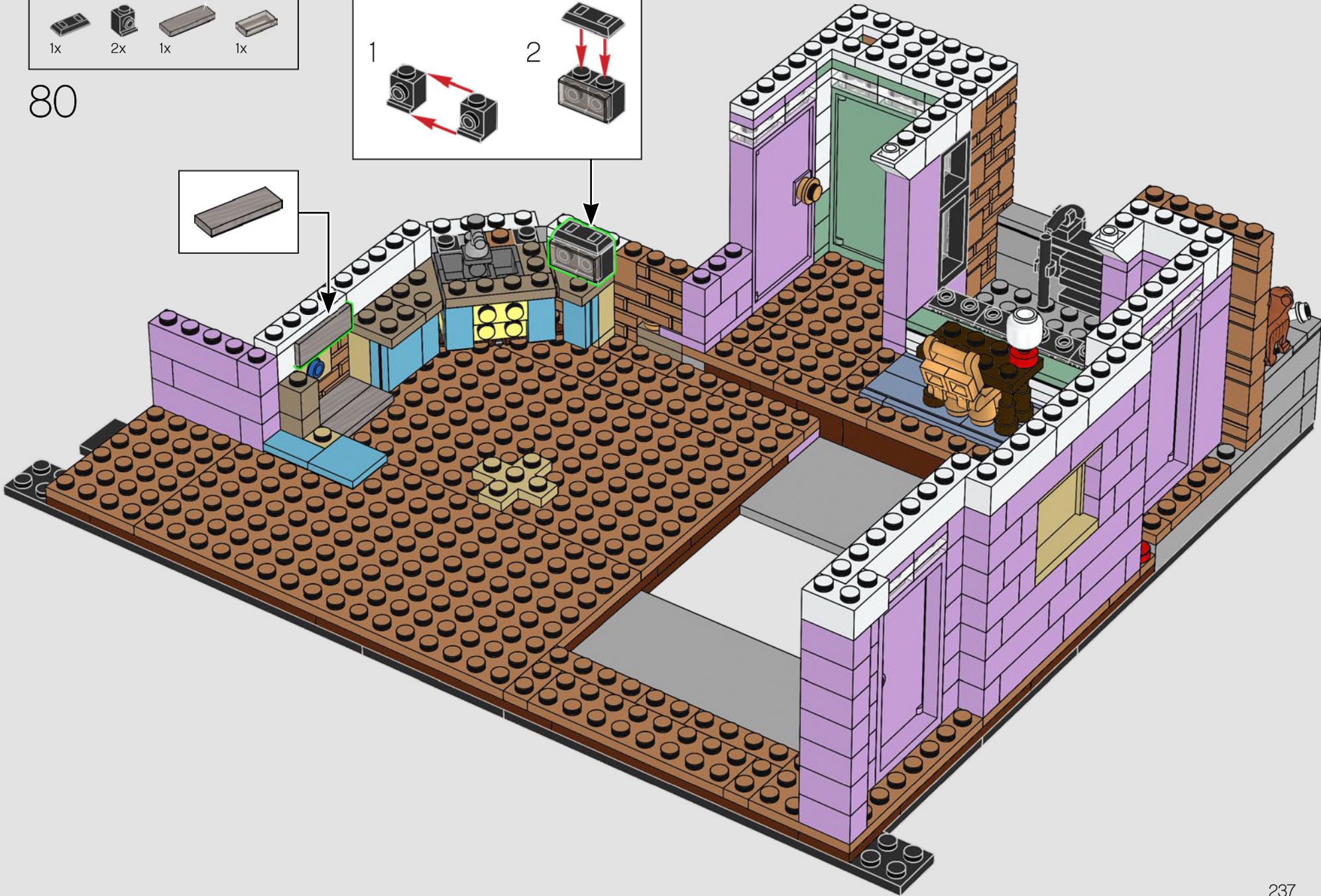
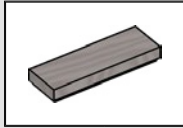
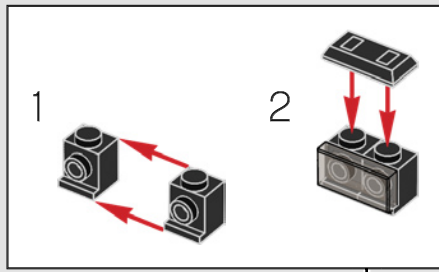

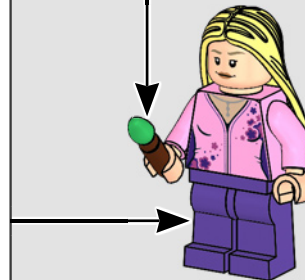
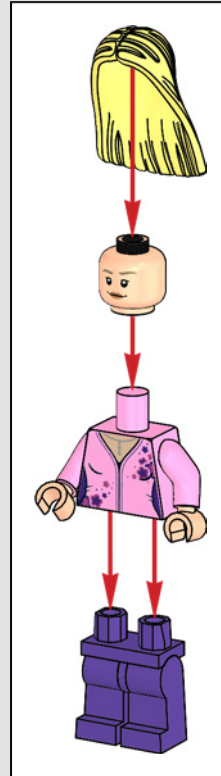
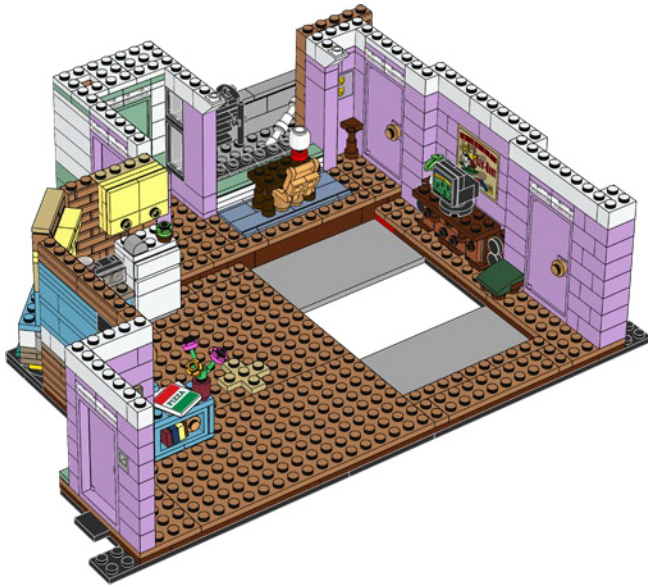
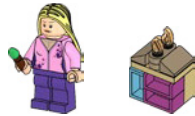
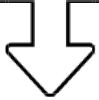

La colorida casa de muñecas hecha a mano de Phoebe... ¡que terminó reducida a cenizas por accidente!





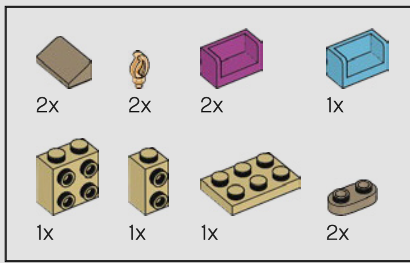

1

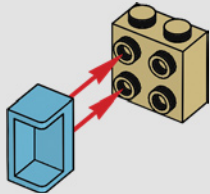

2

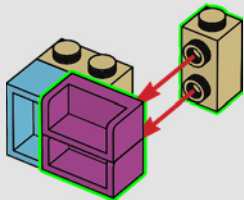

3

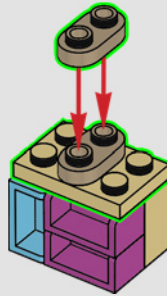

4

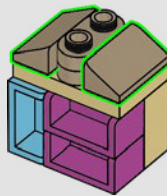

5

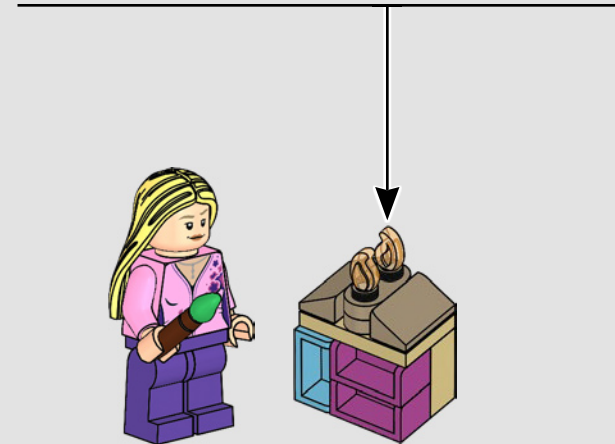
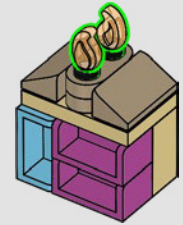

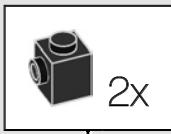
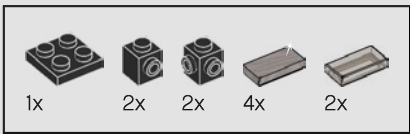

81

1

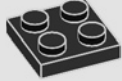

2

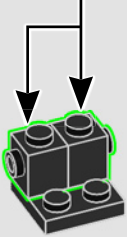

3

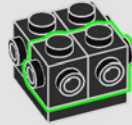

4

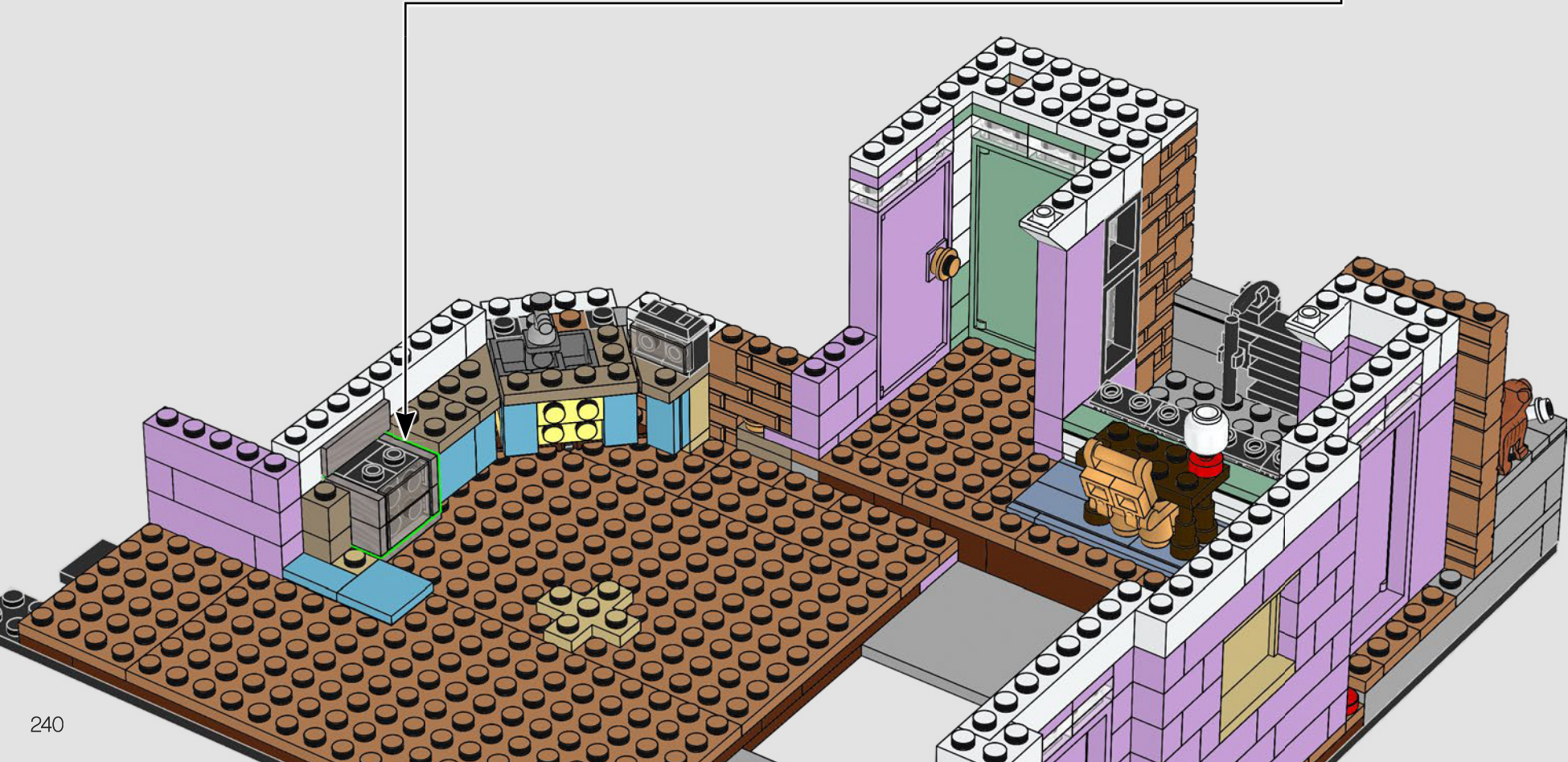
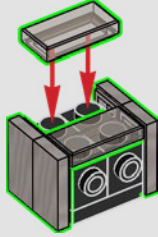

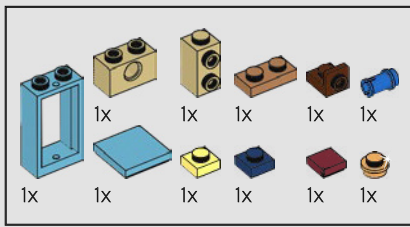

82

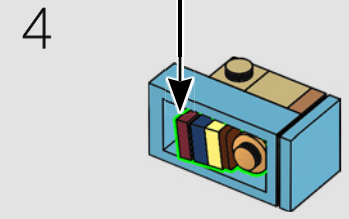
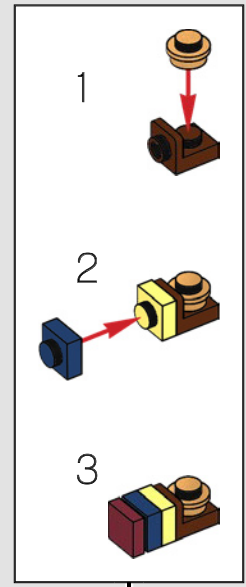
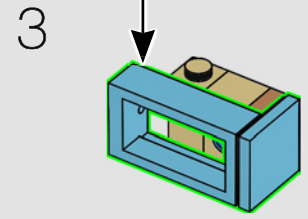
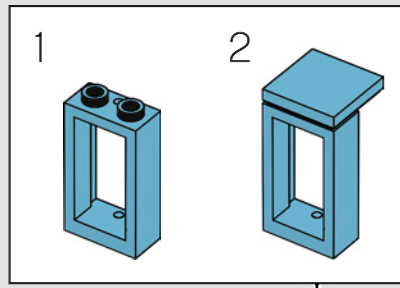
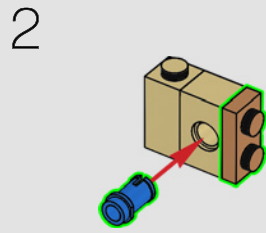
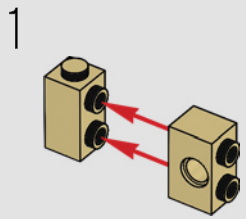







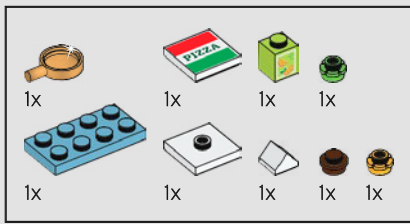

83

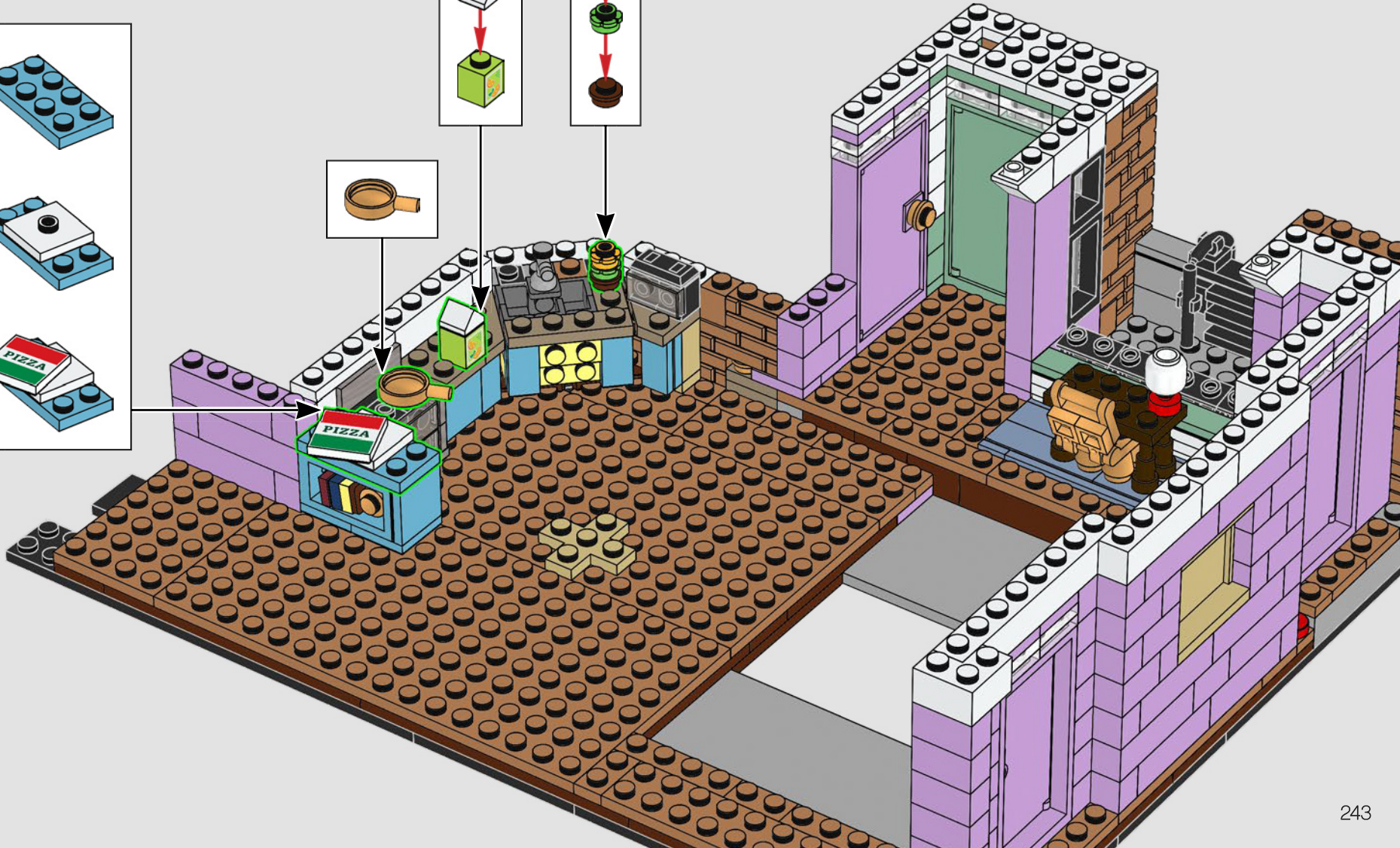
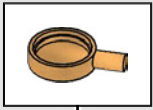
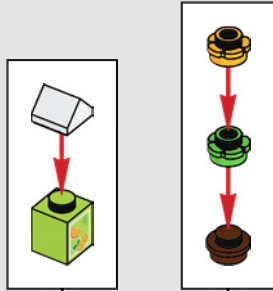
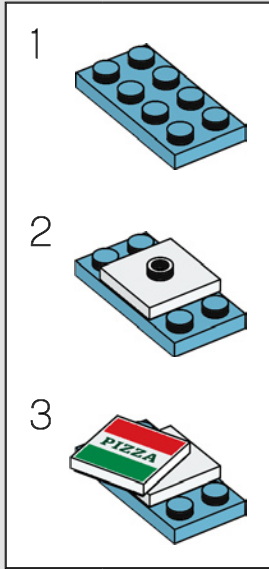



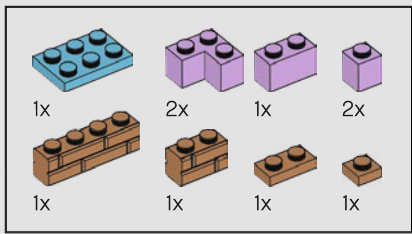

84

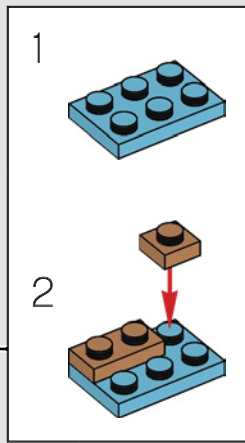



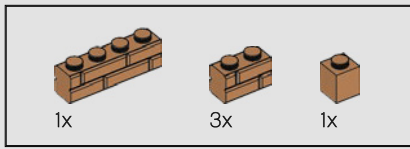

85

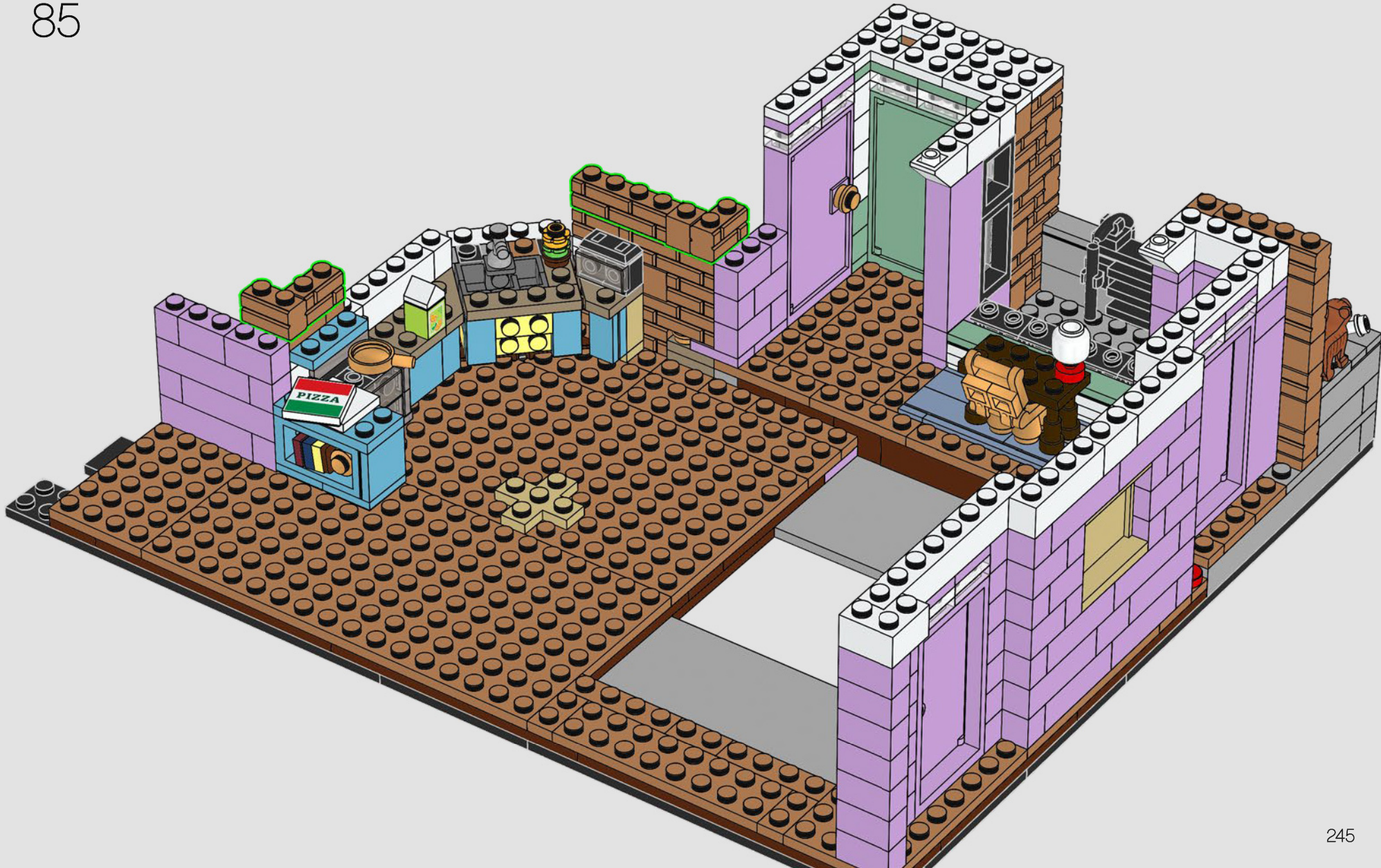



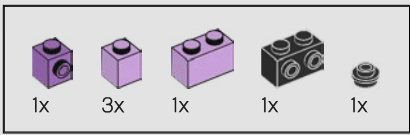

86

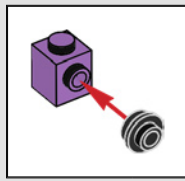



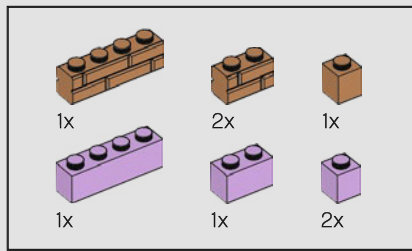

87





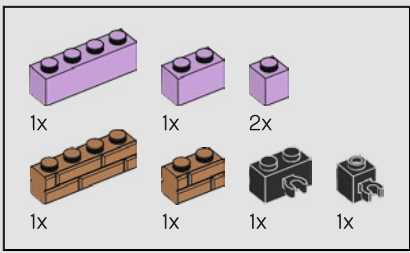

88



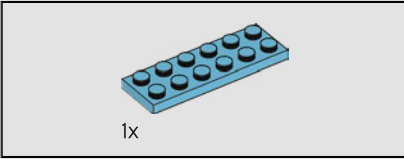
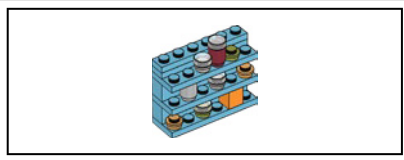

1x

89

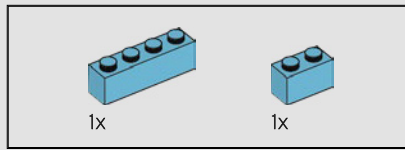
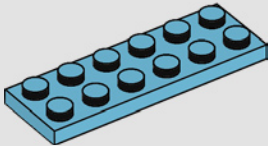

90

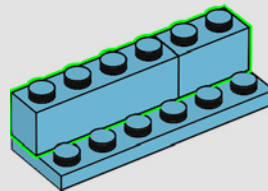

91

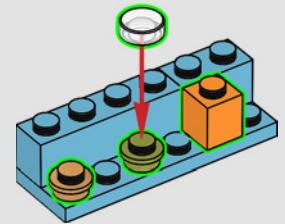

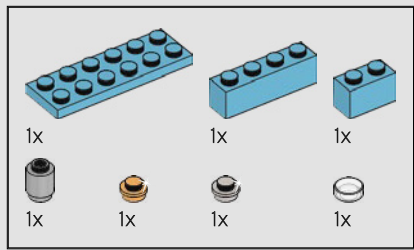

92

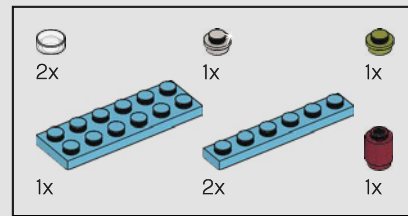
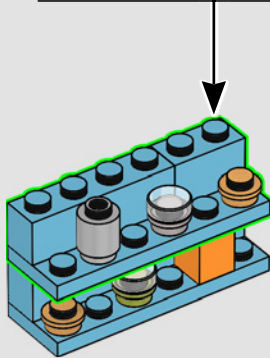
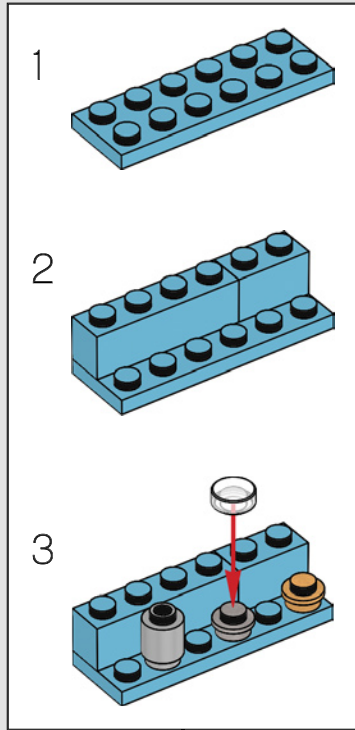

93

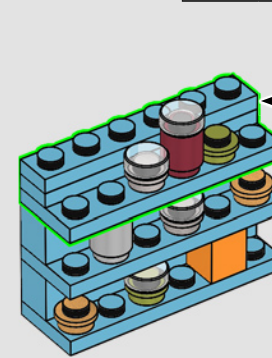
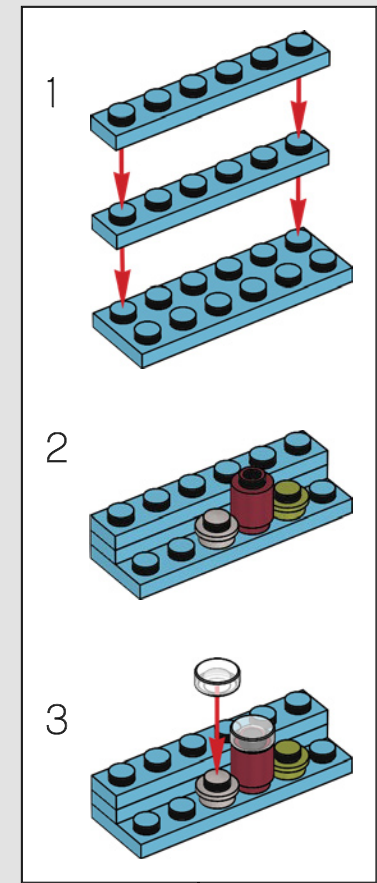



94

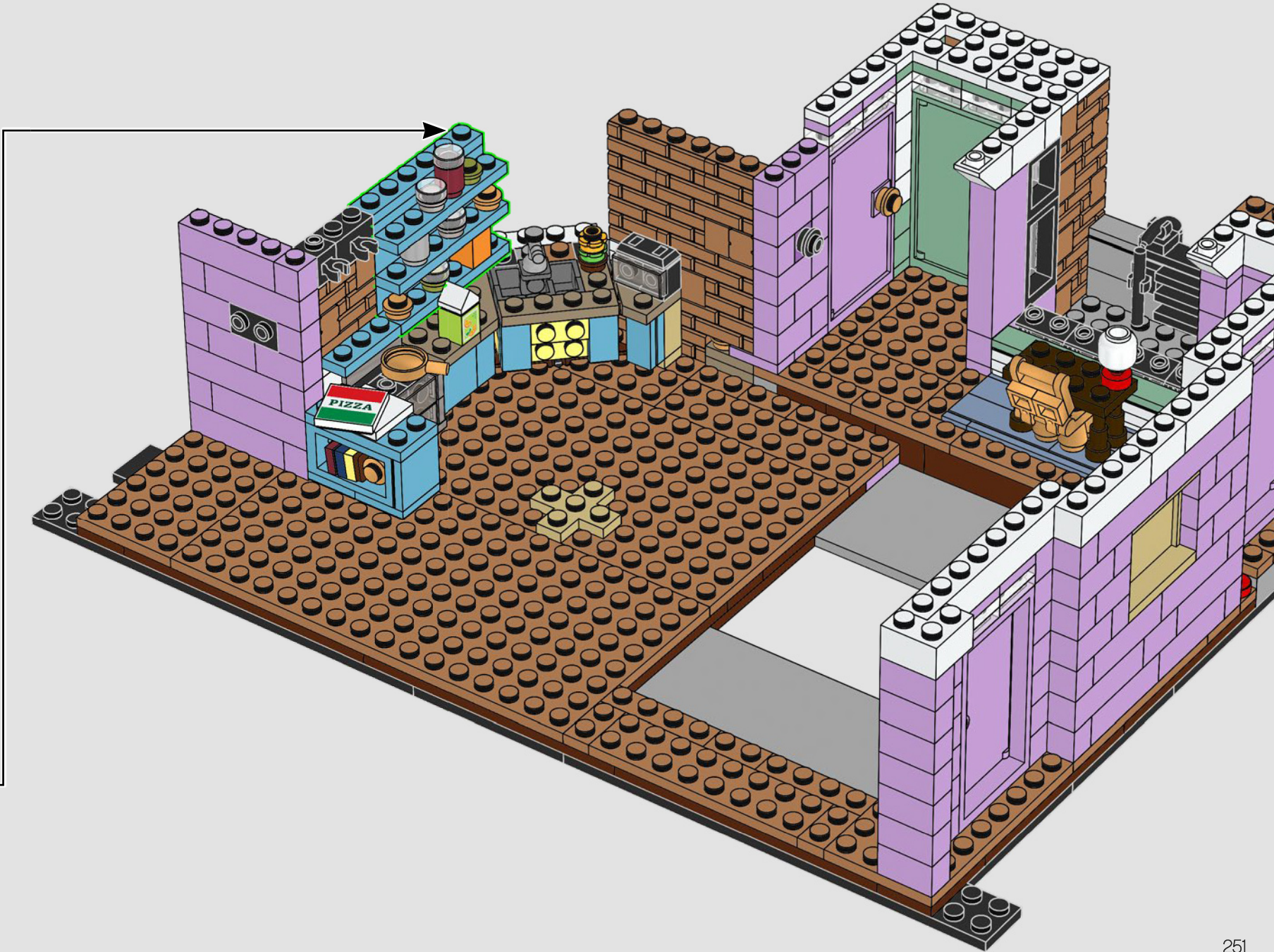

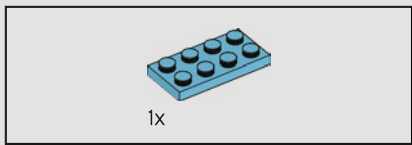

95

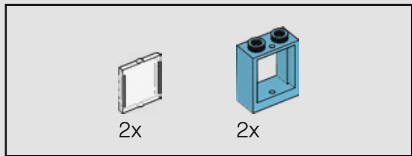
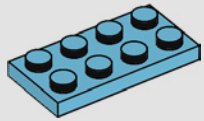

96

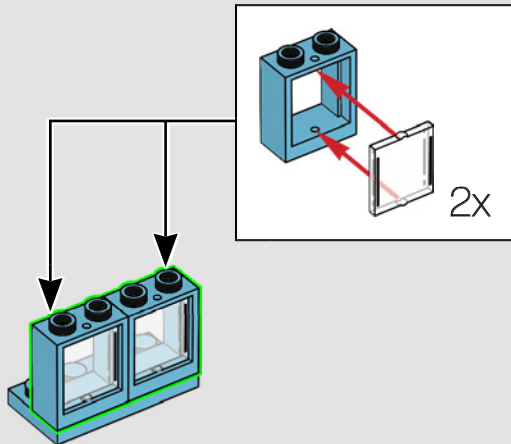

97

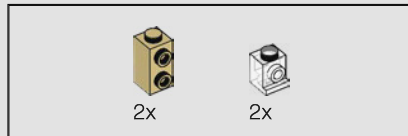
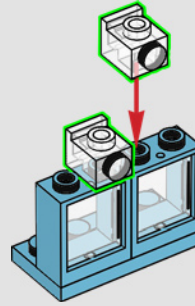

98

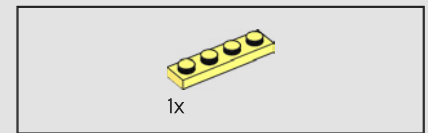
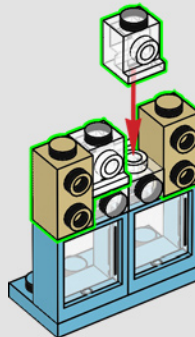

99

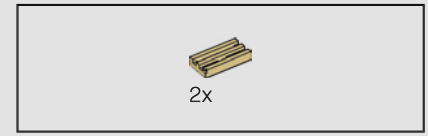
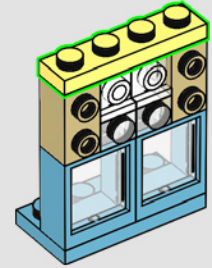

100

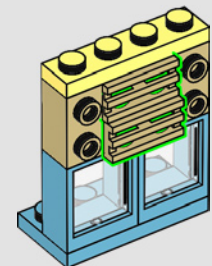

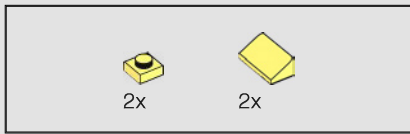

101

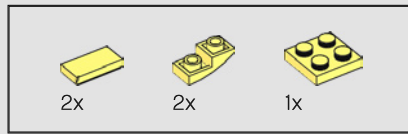
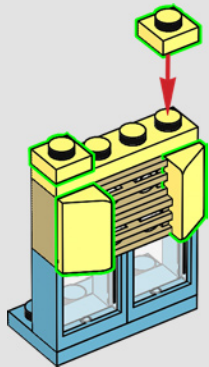

102

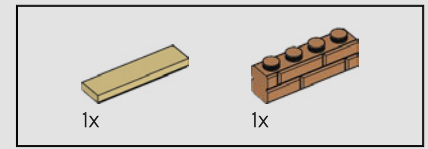
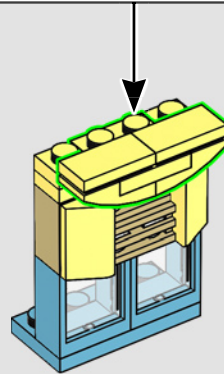
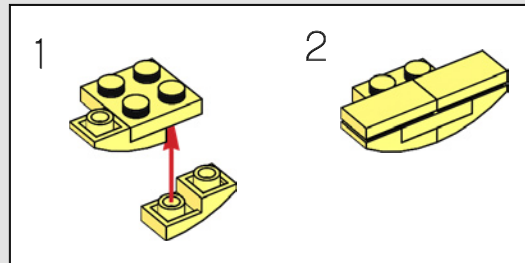

103

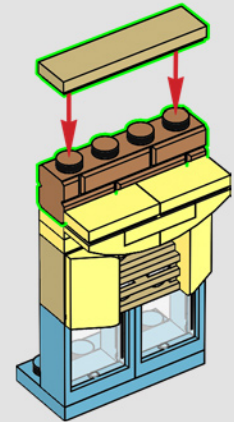



104

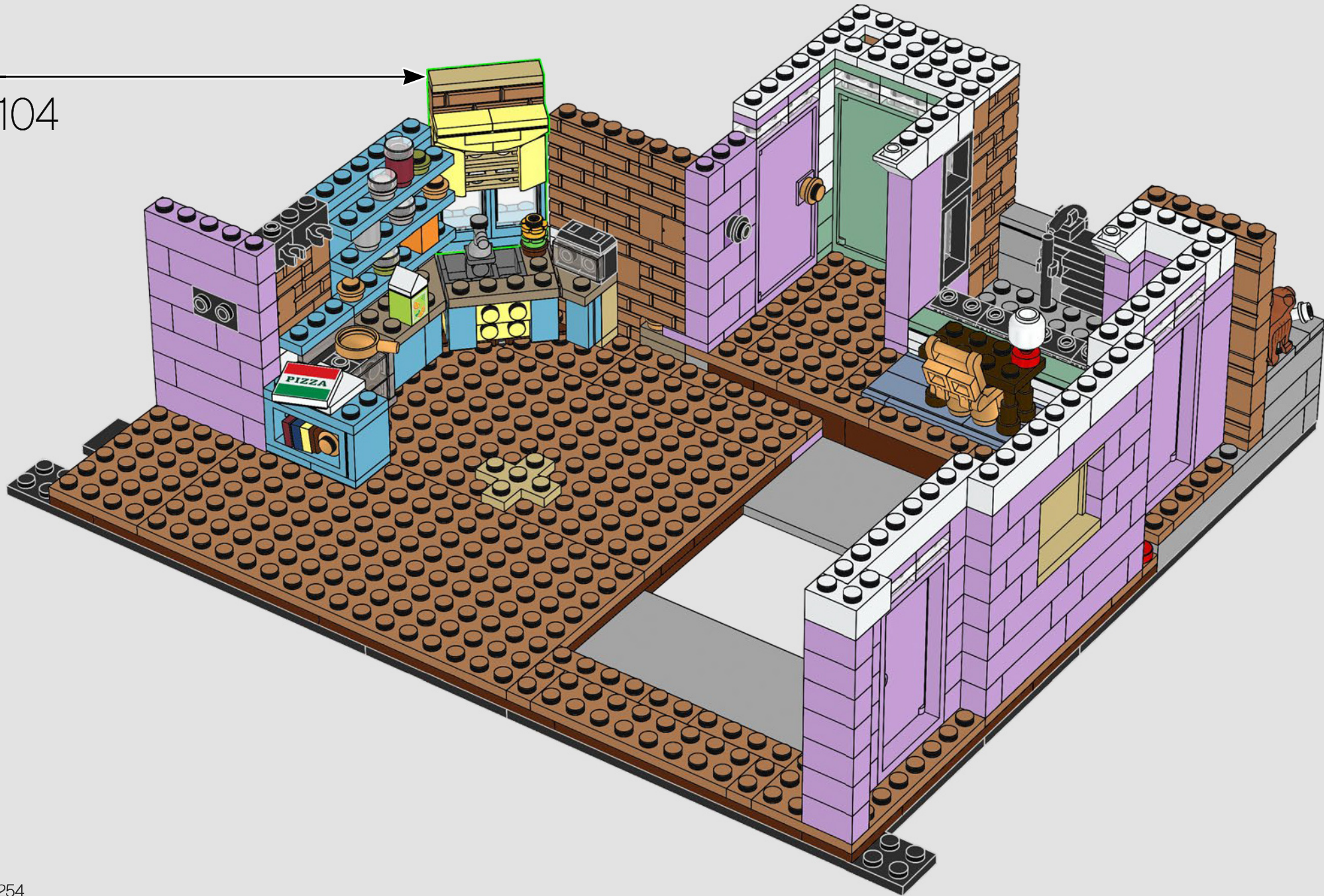

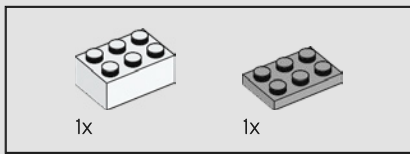

105

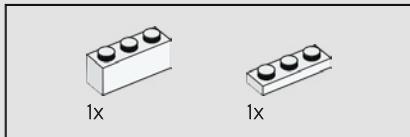
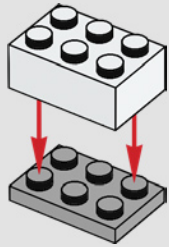

106

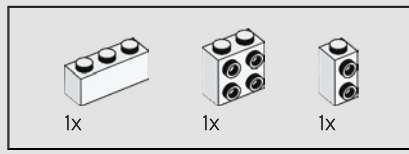
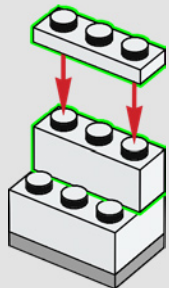

107

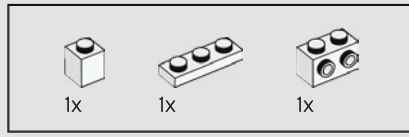
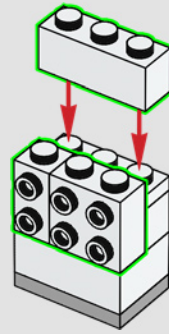

108

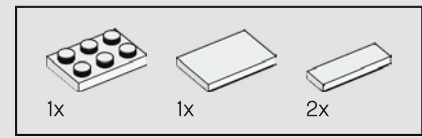
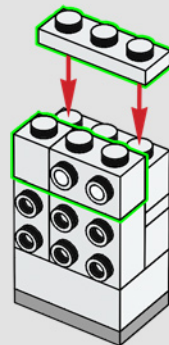

109

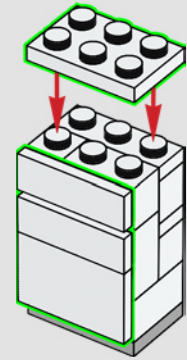

110

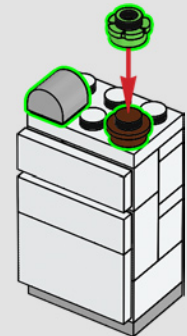



111

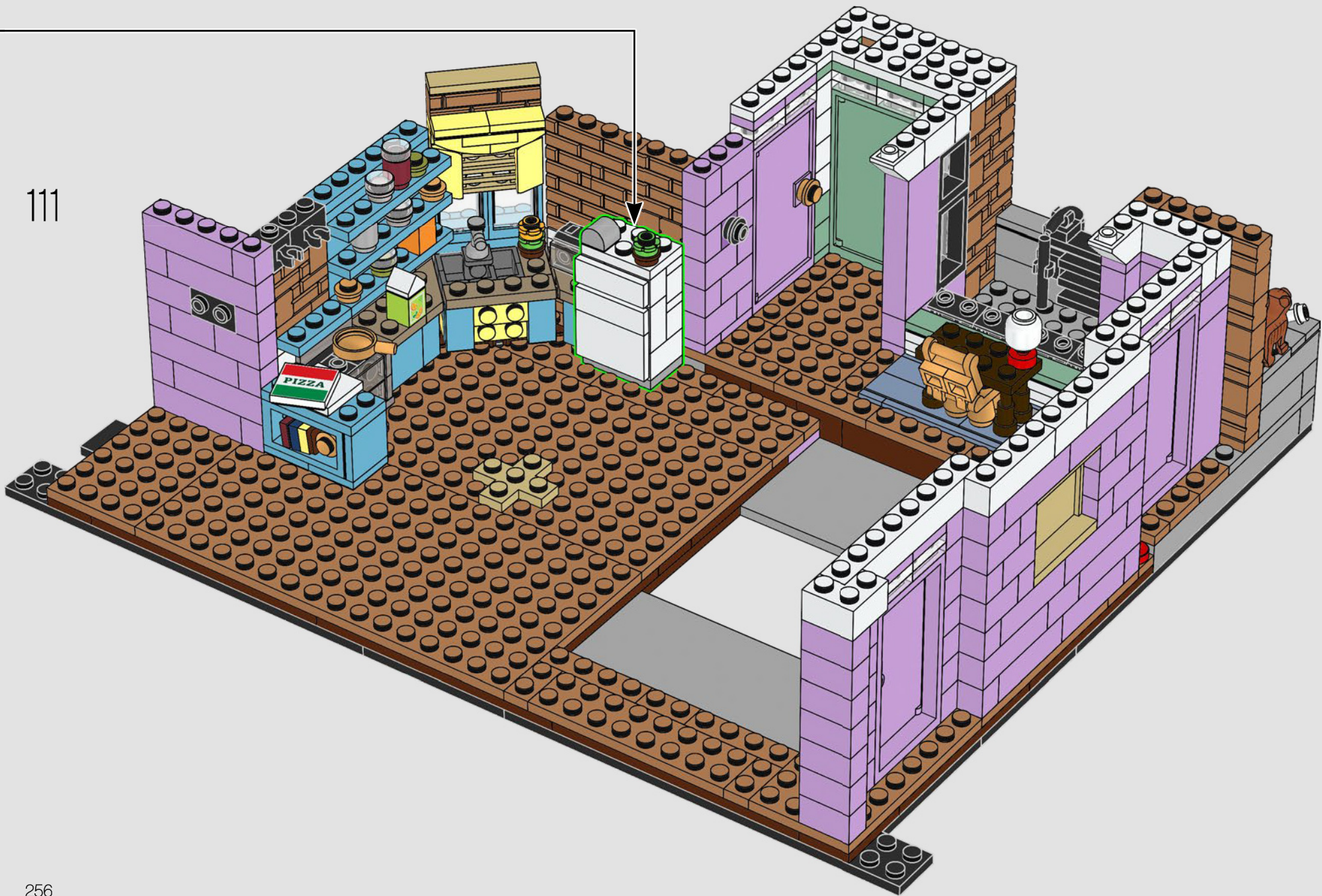



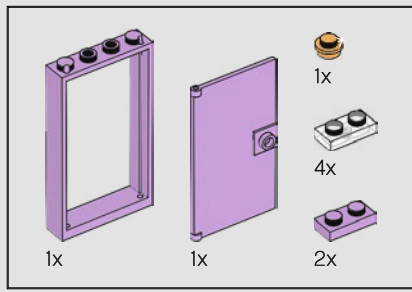

112

1

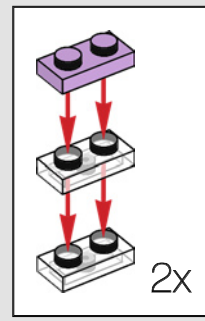
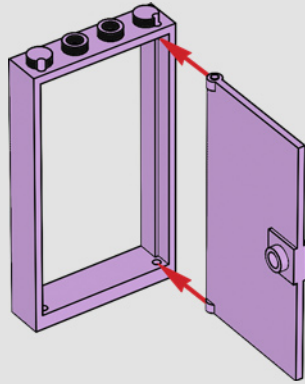

2

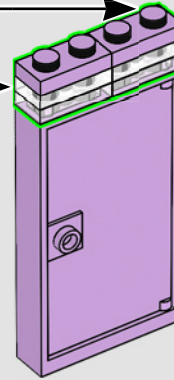

3

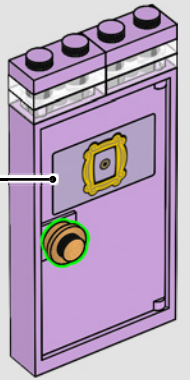

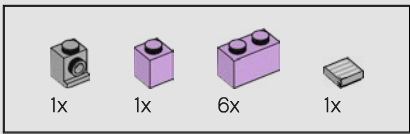

113

1

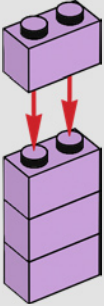

2

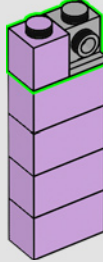

3

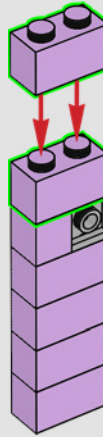

4

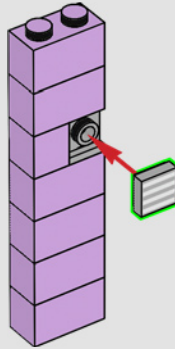



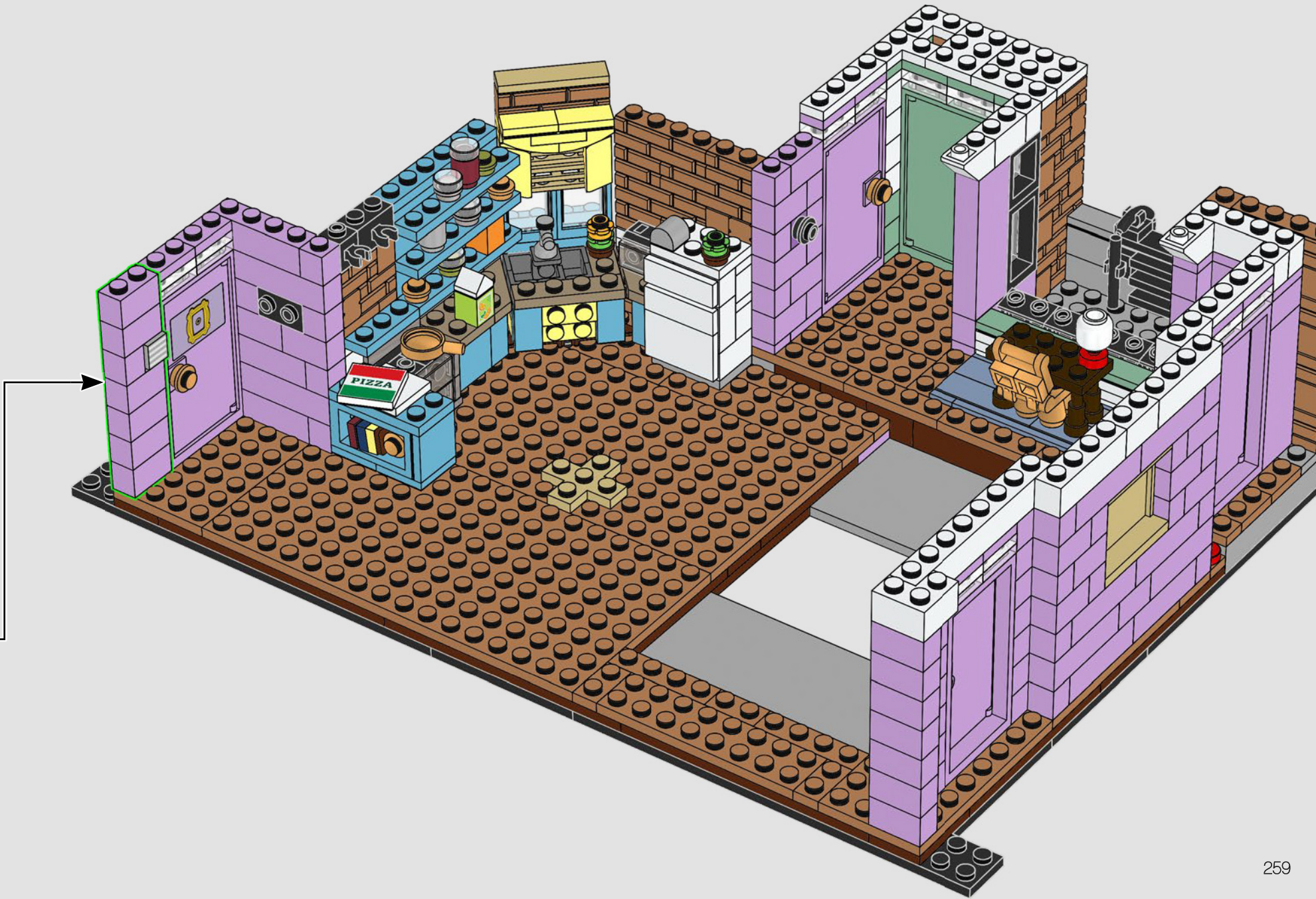



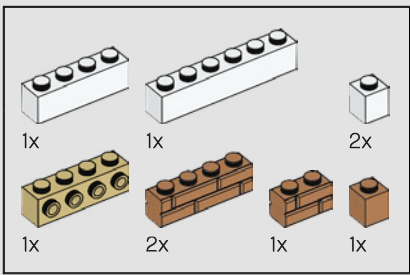

114





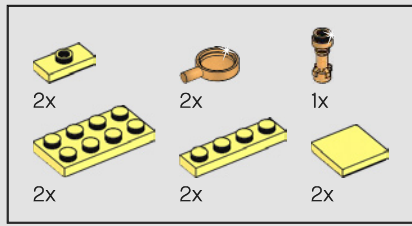

115

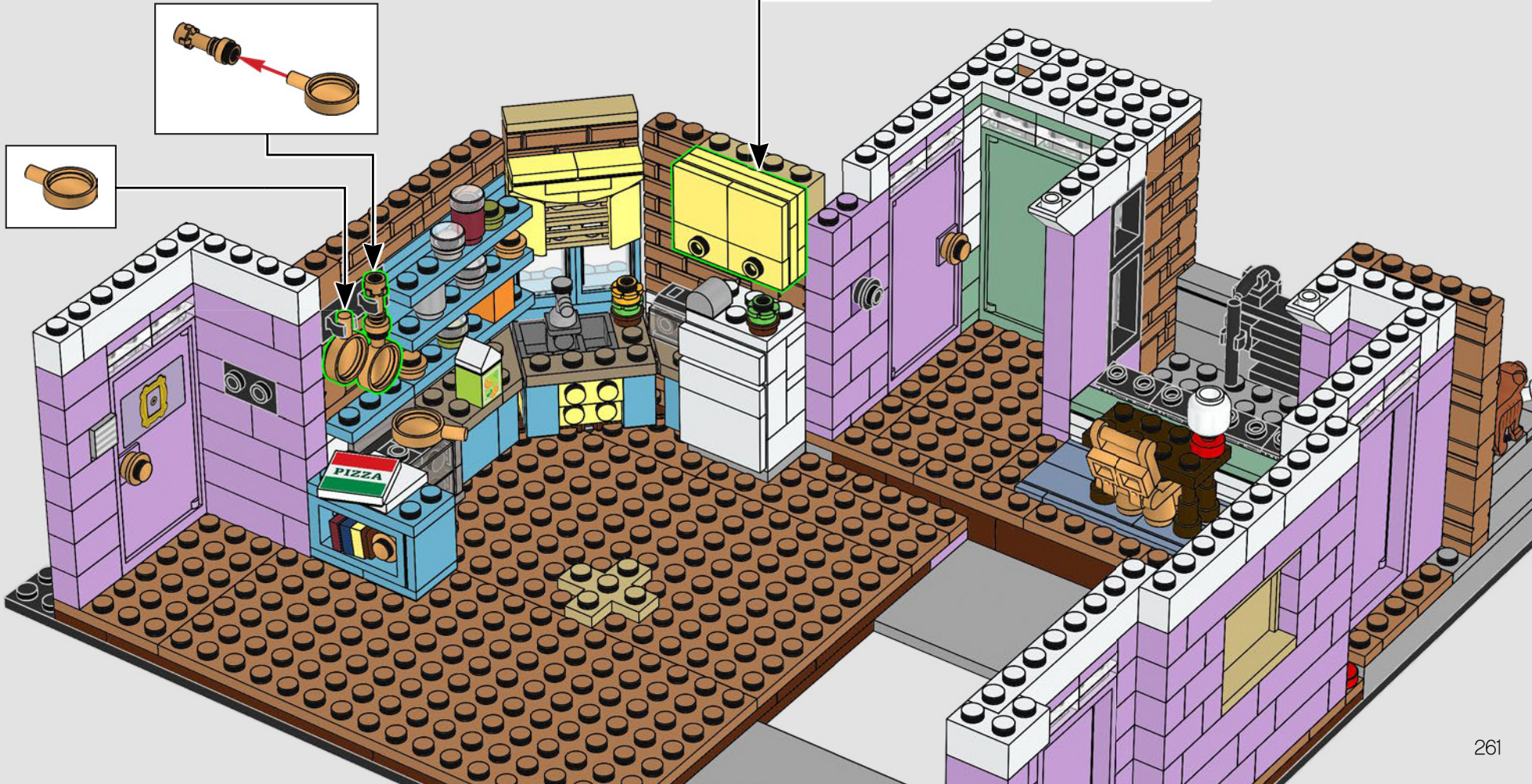
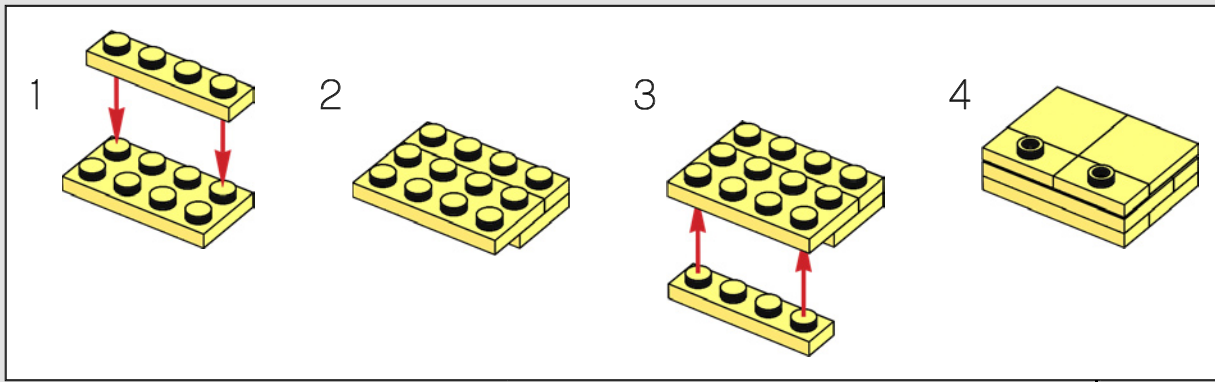





116

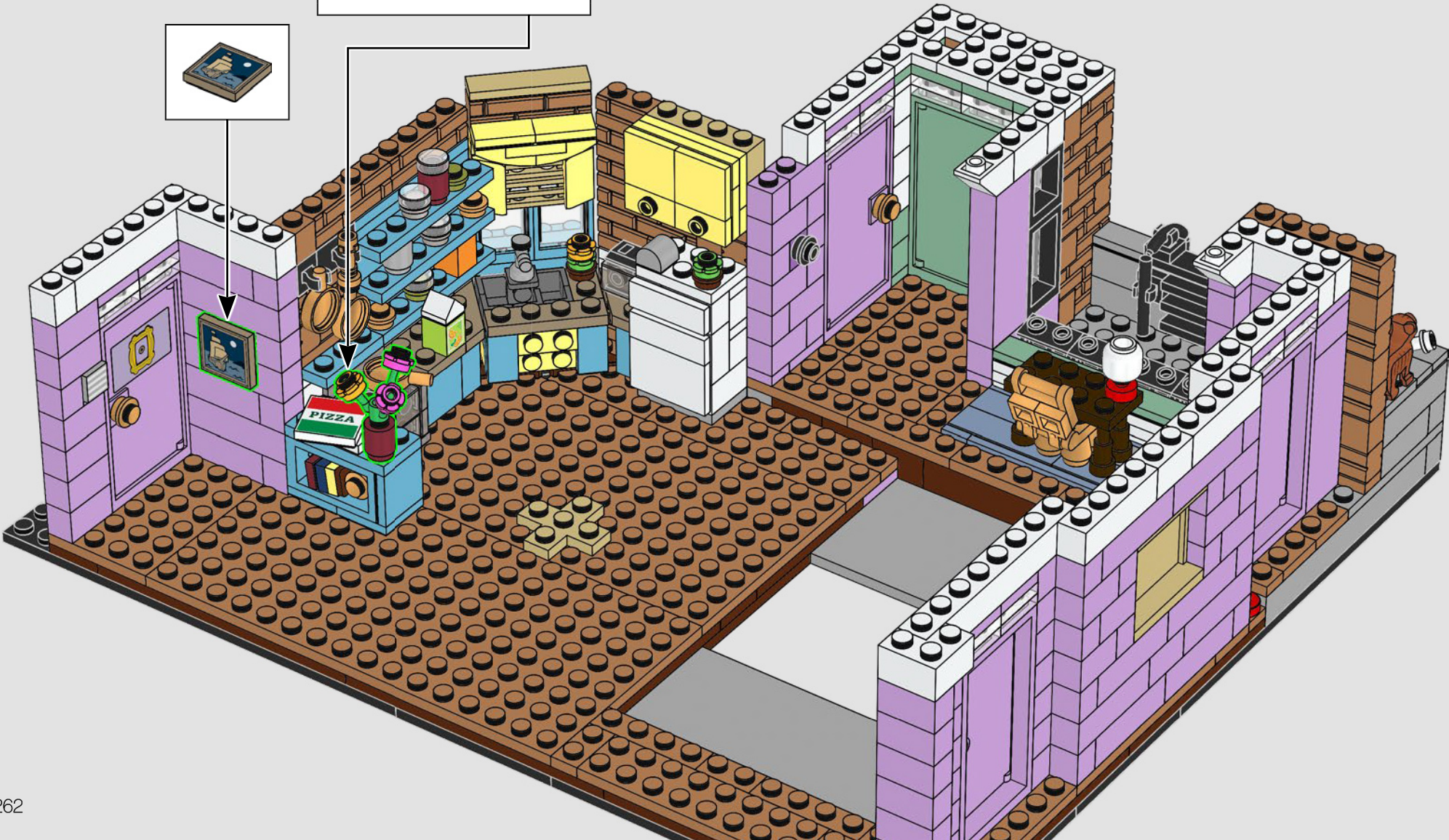
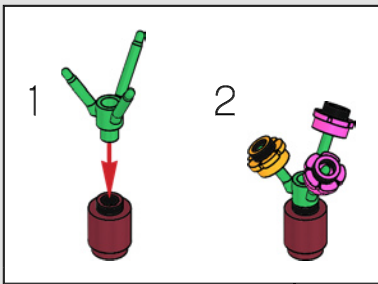



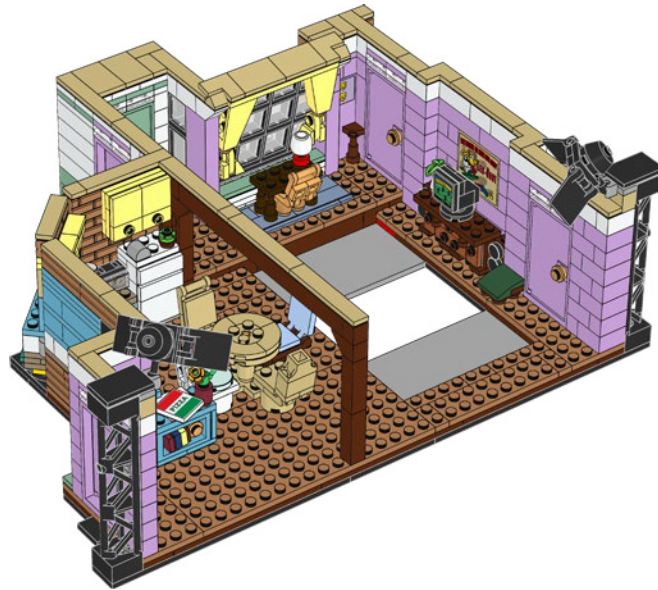

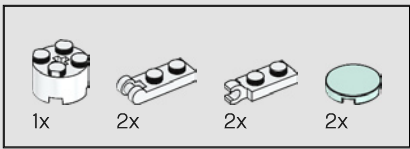

117

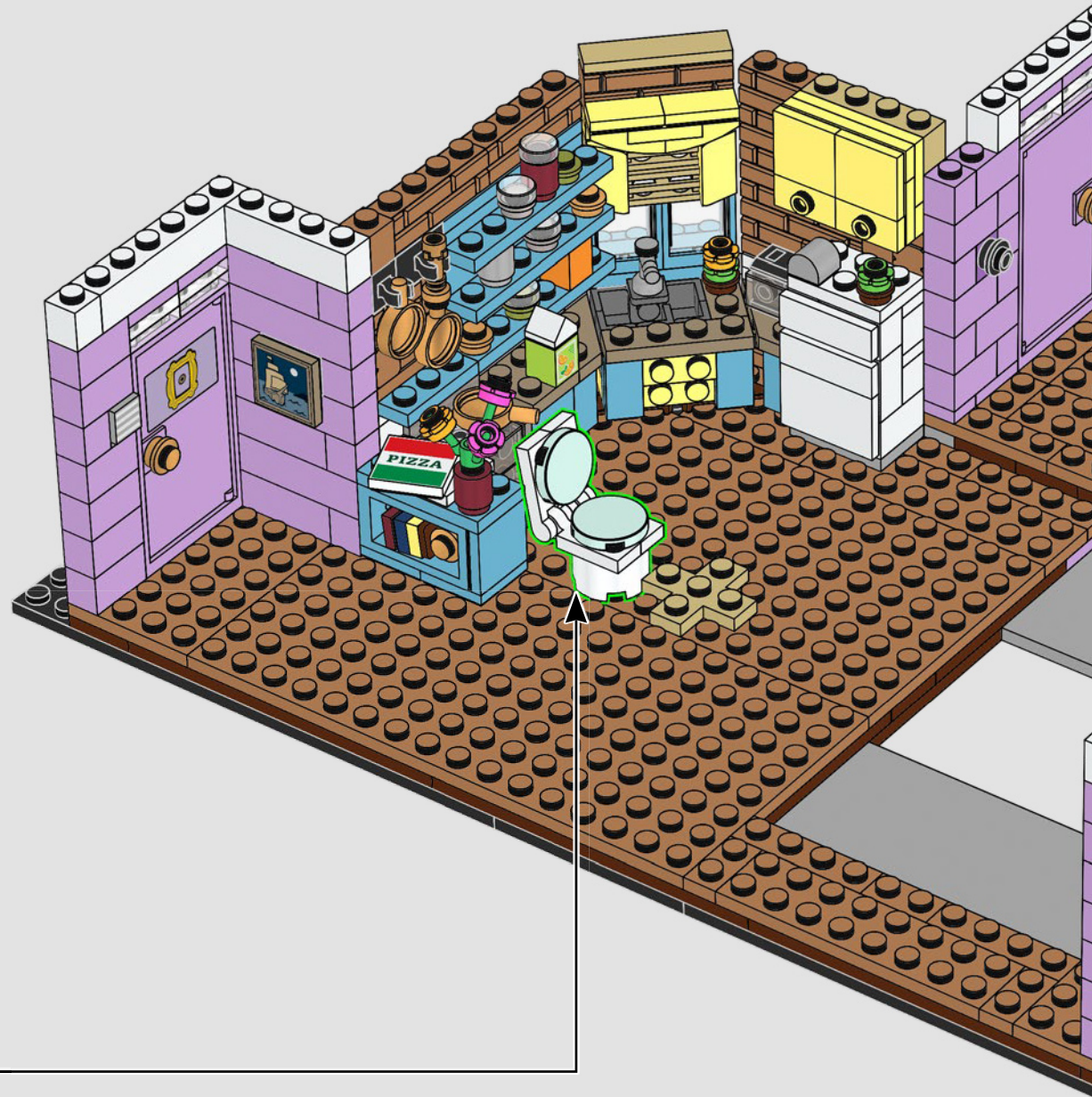
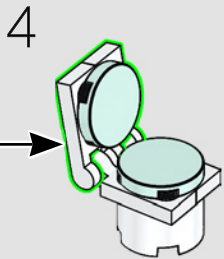
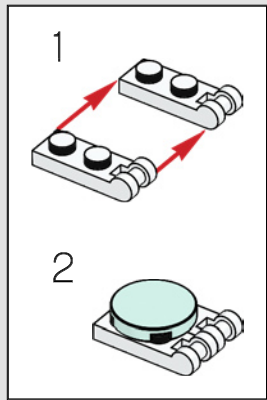
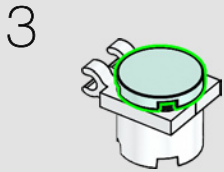
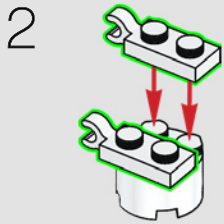
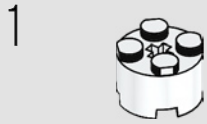



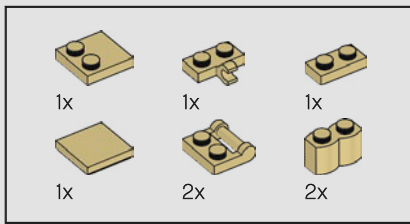

118

1

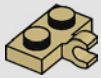

2

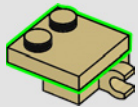

3

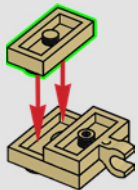

4

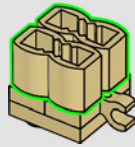

1

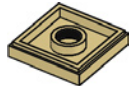

2

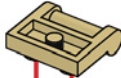

5

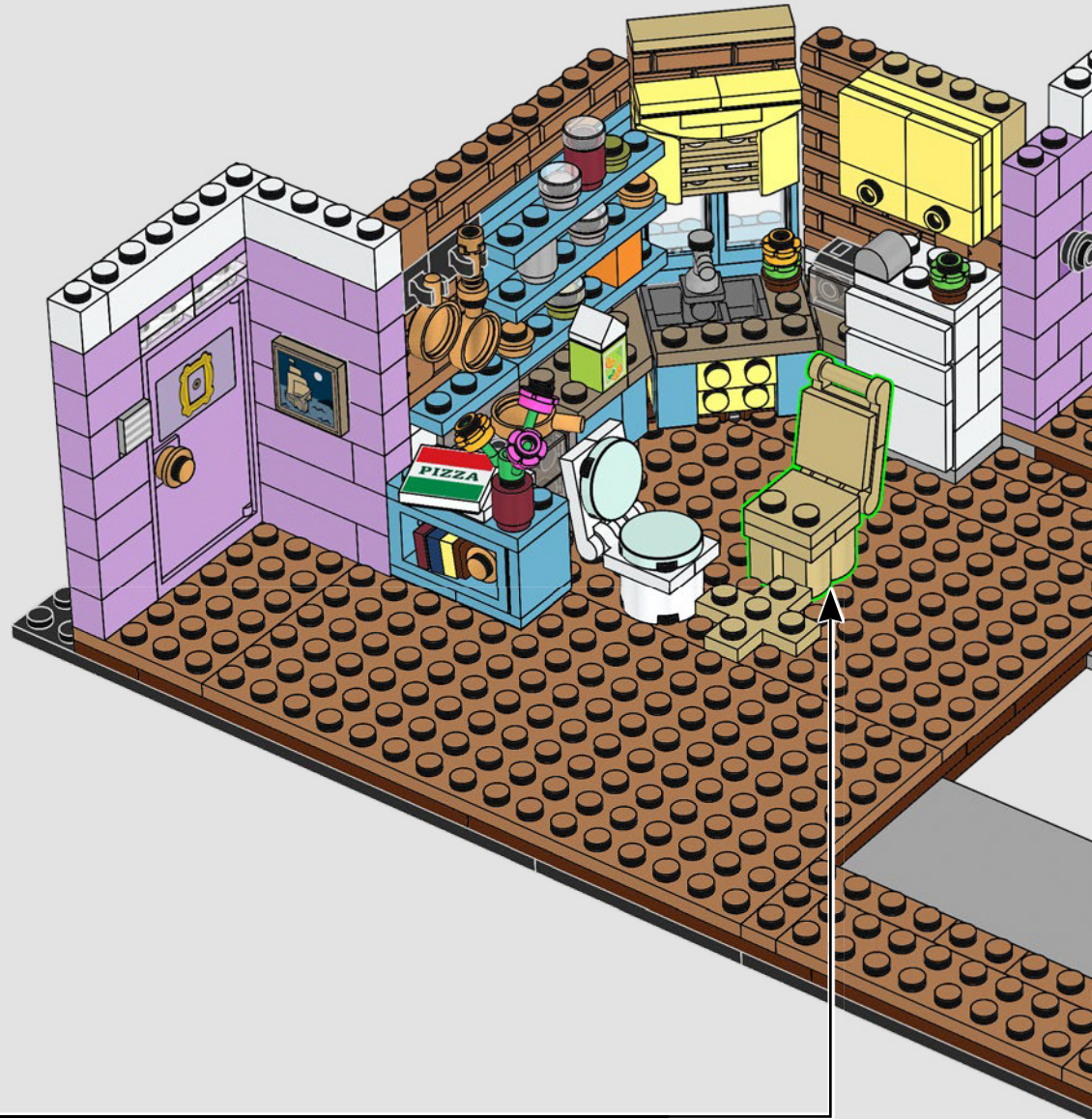
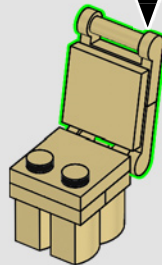



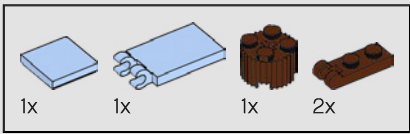

119

1



2



3

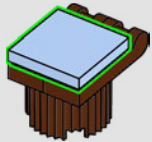

4

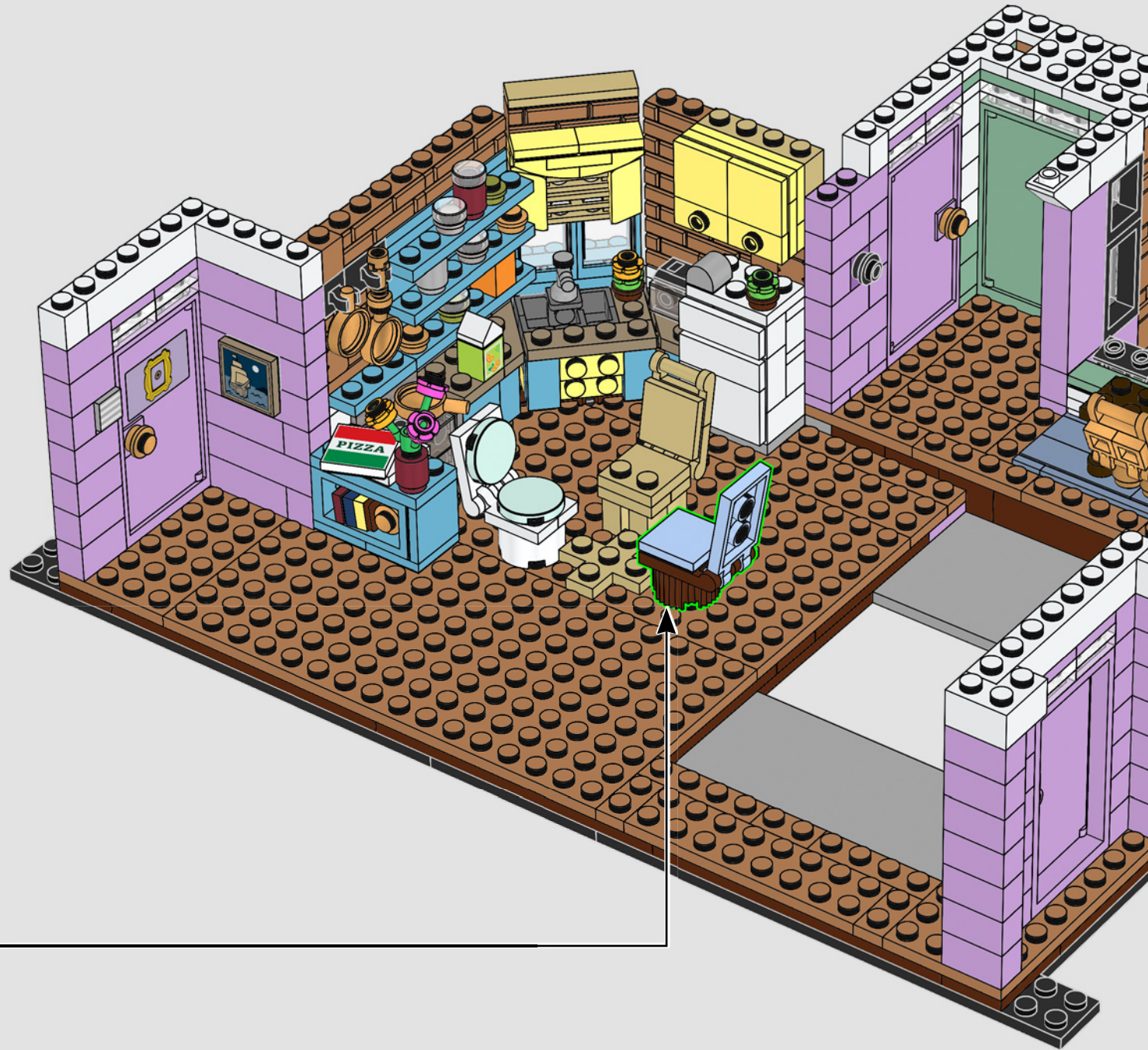
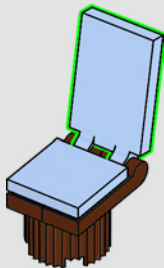



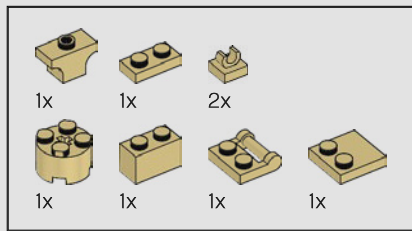

120

1

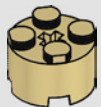

2

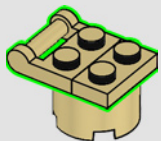

3

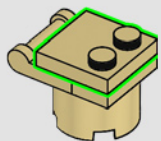

1



2



3

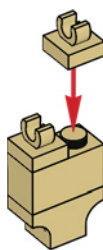

4

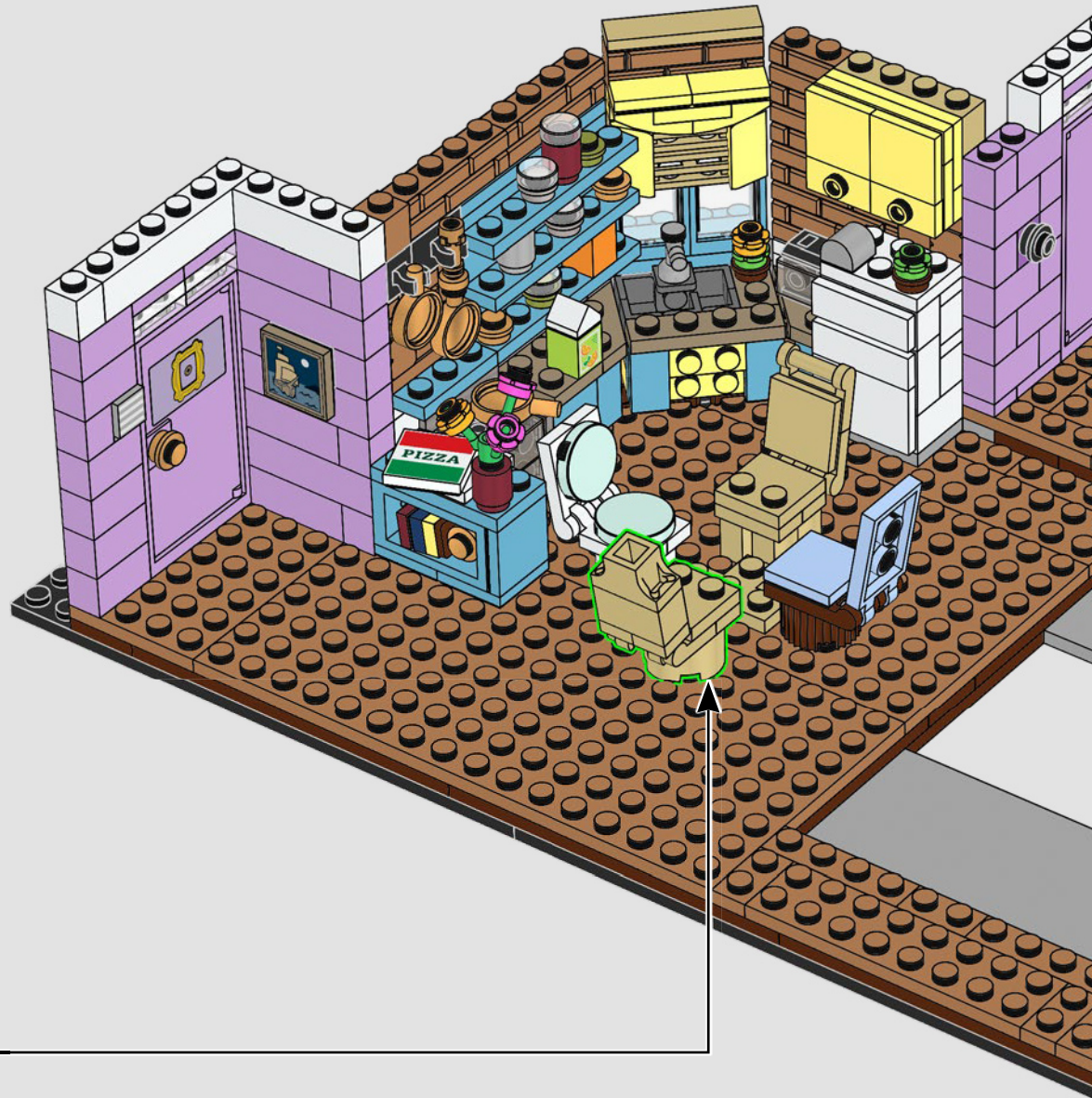
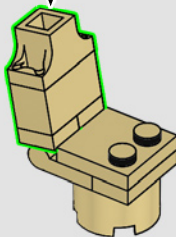

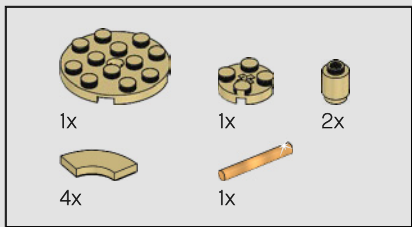

121

1



2

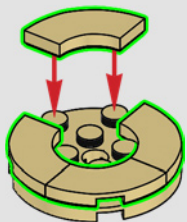

3

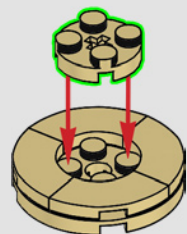

4

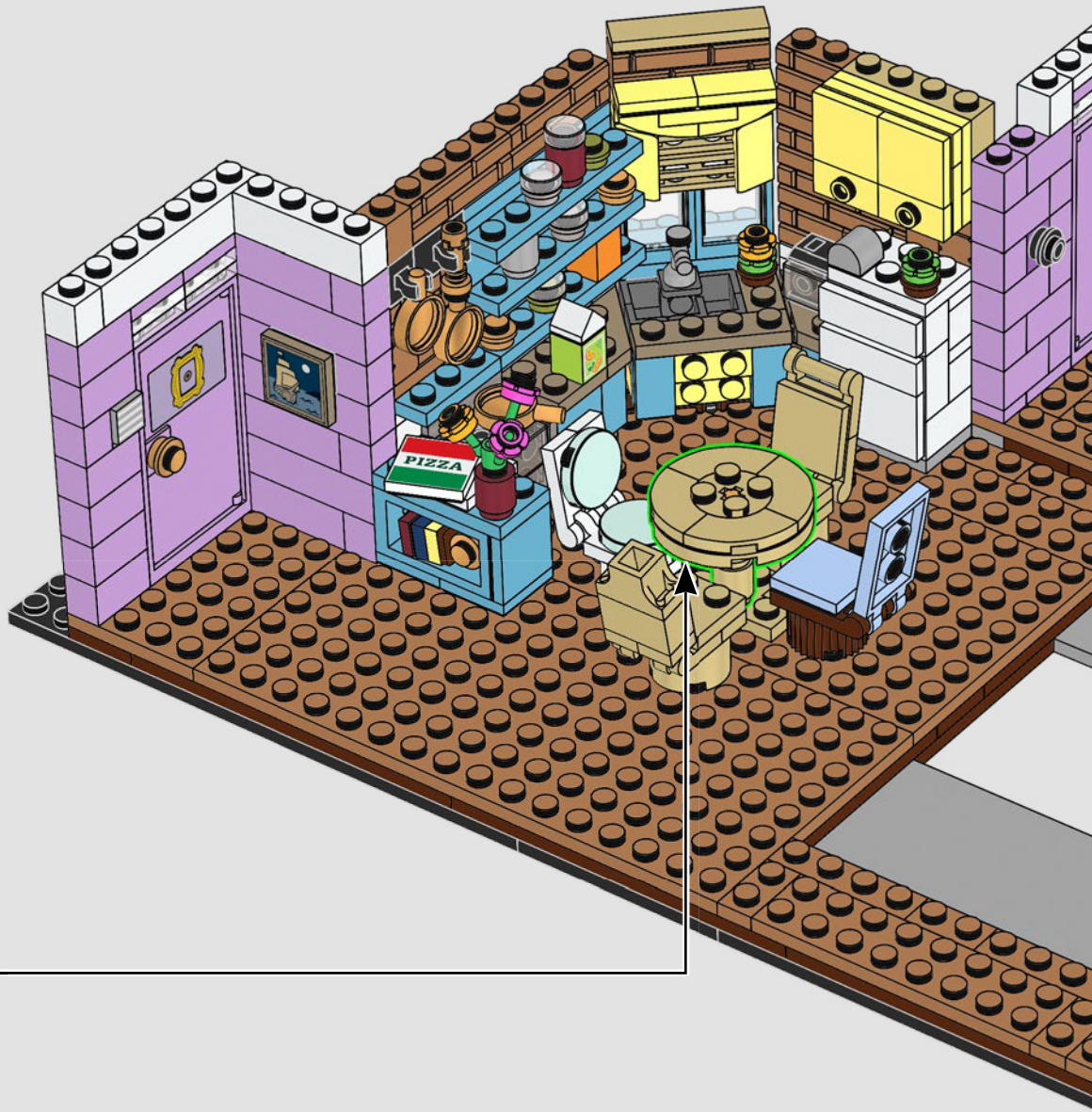
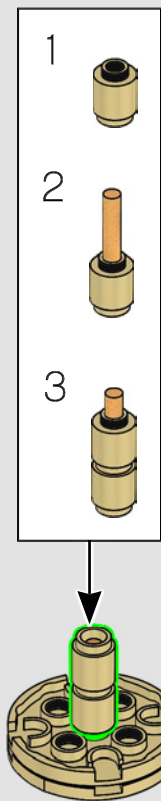



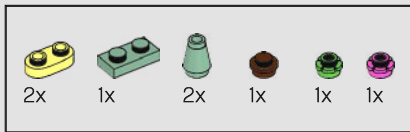

122

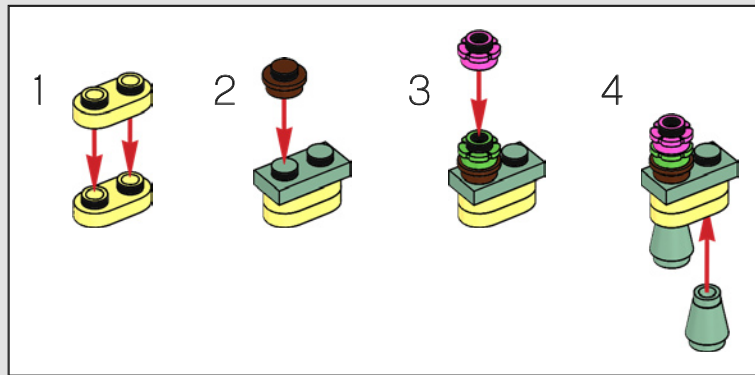



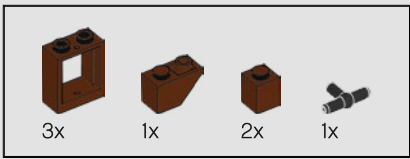

123

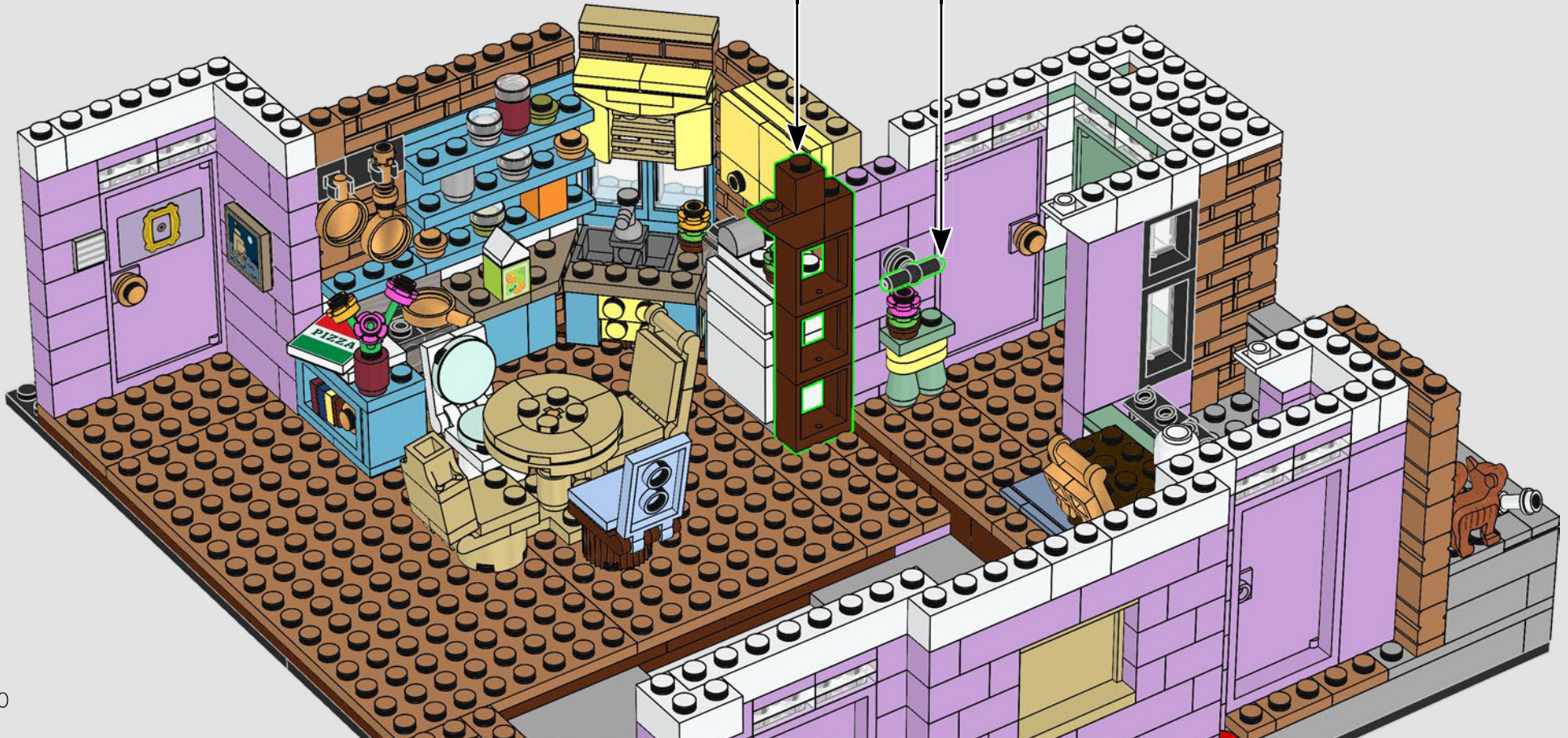
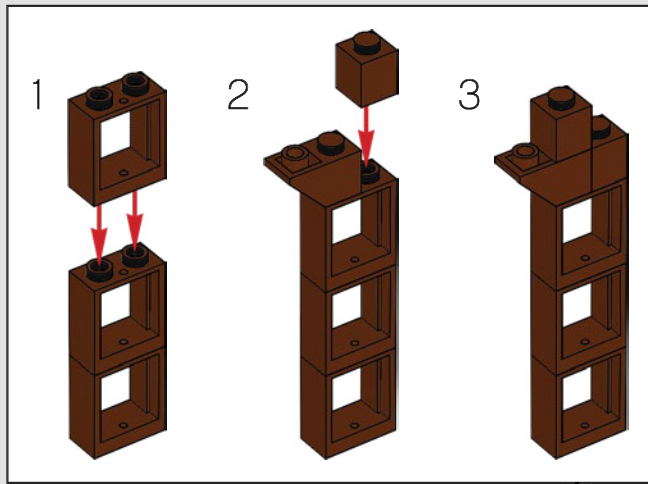



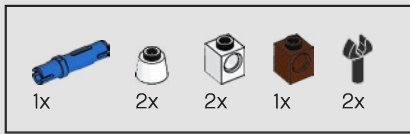

124

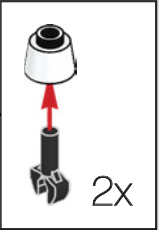
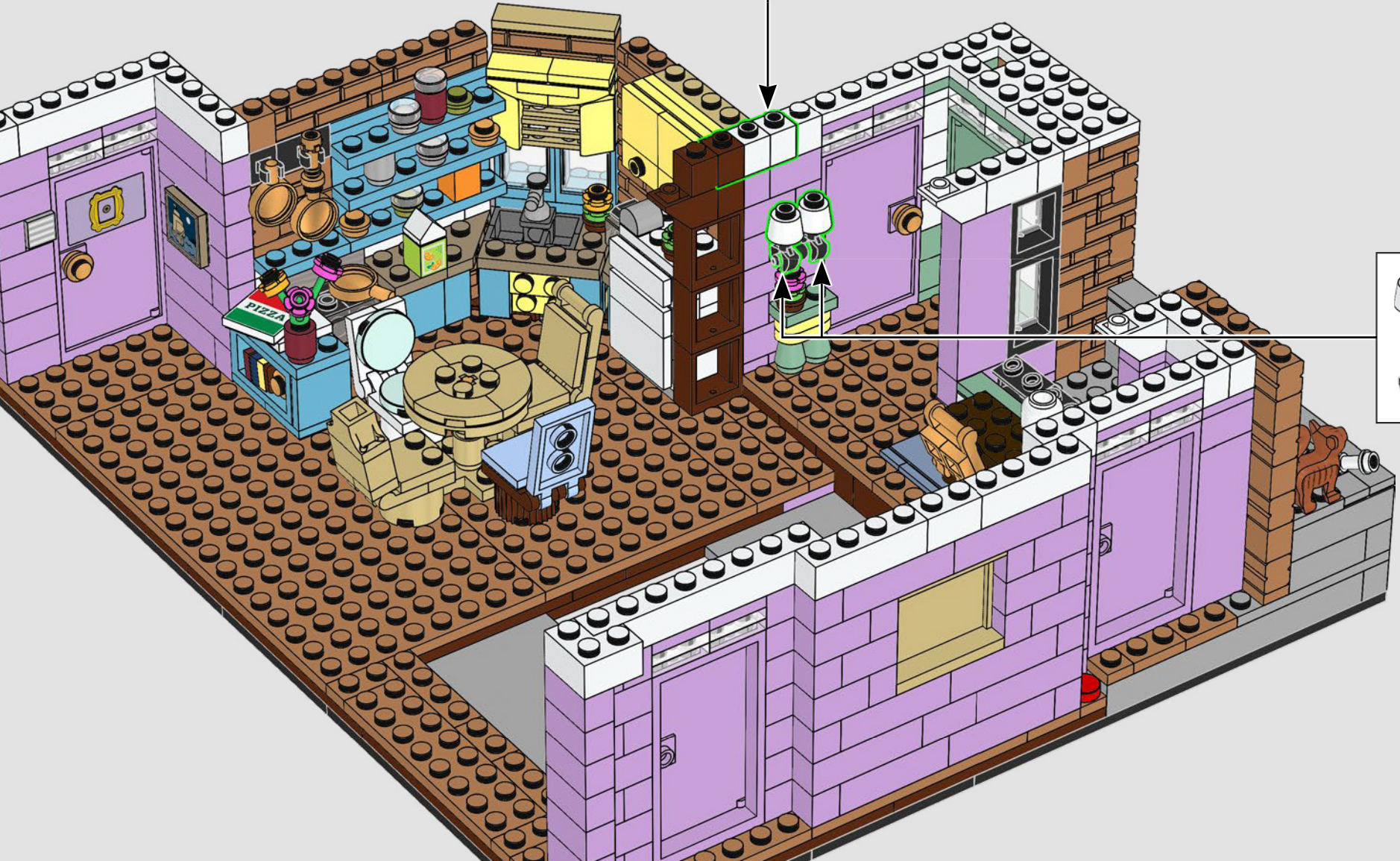
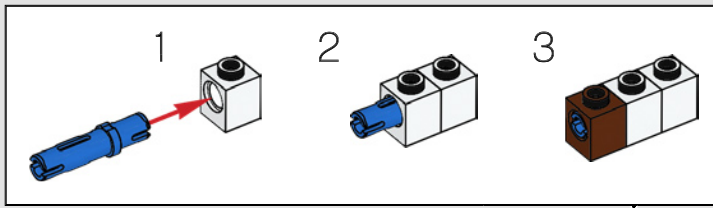



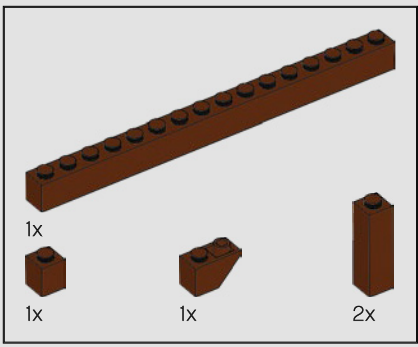

125

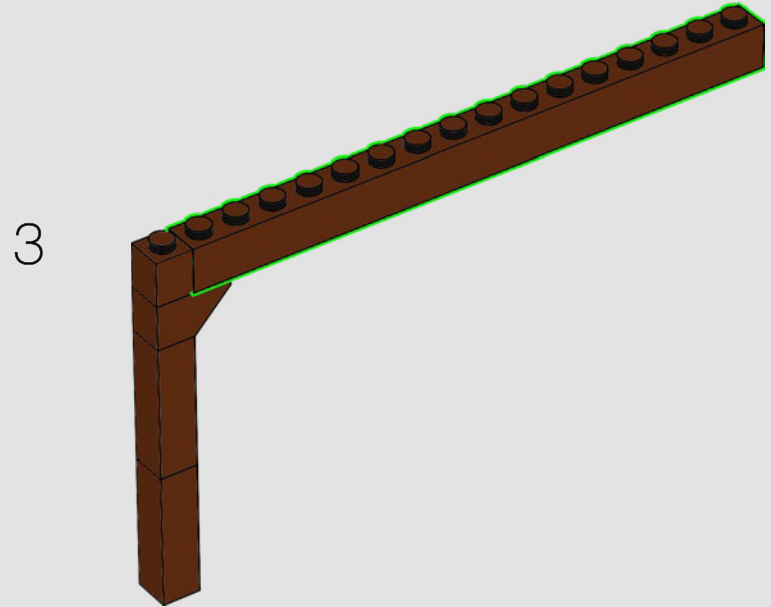
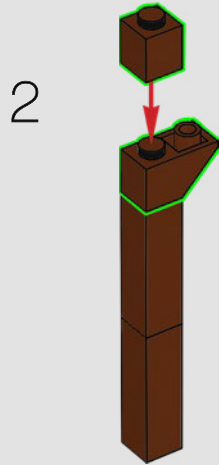
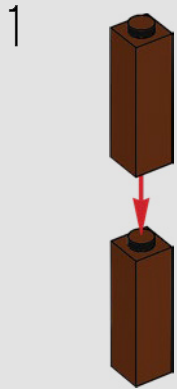





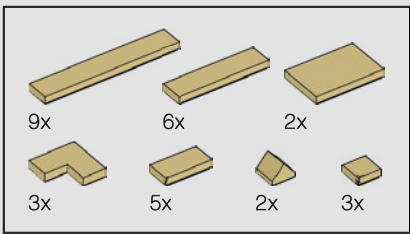

126



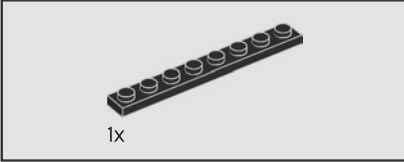
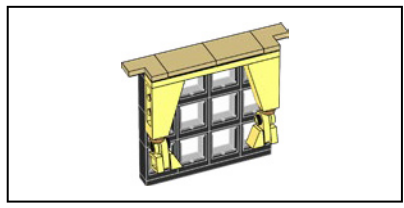

127

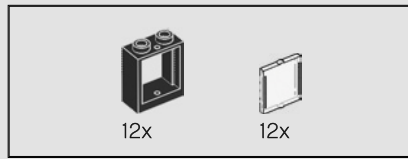
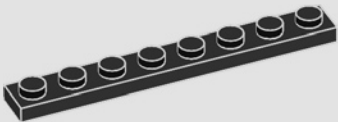

128

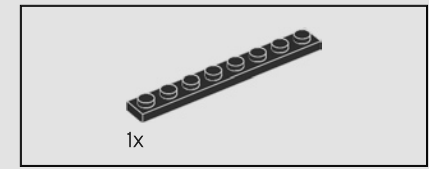
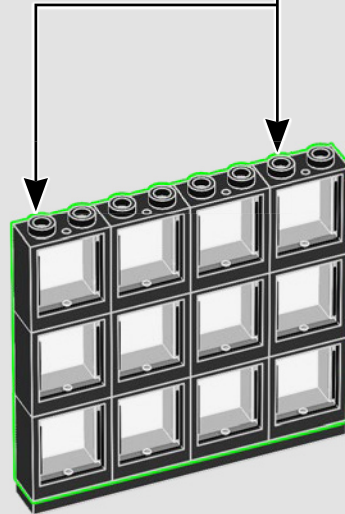
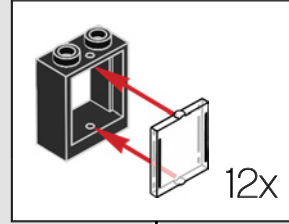

129

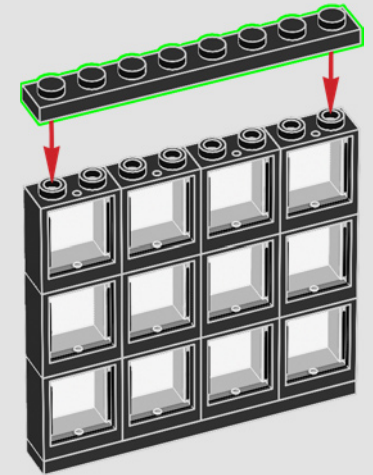



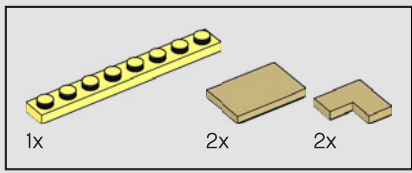

130

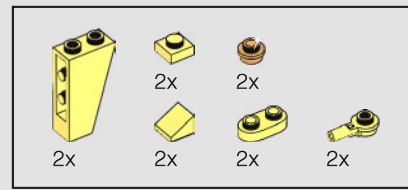
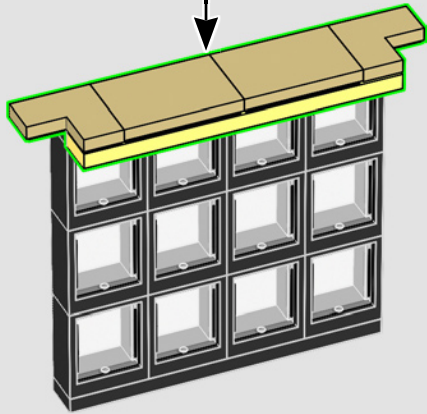
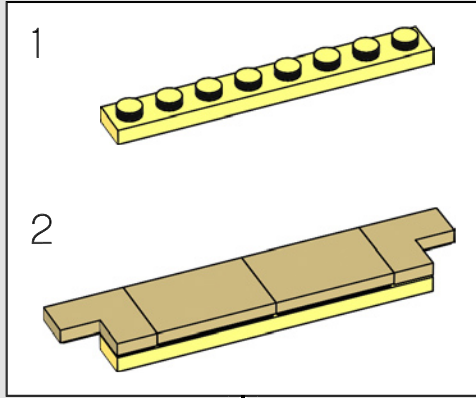

131

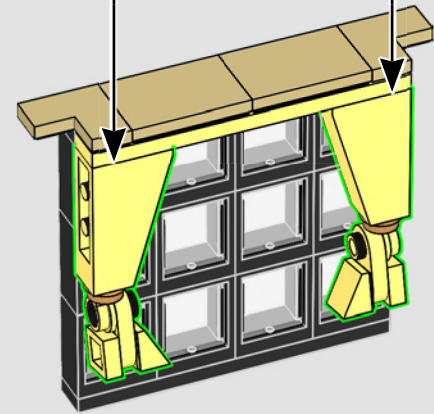
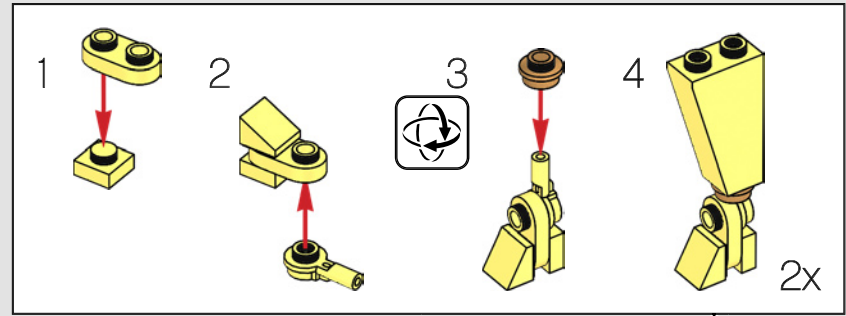

132

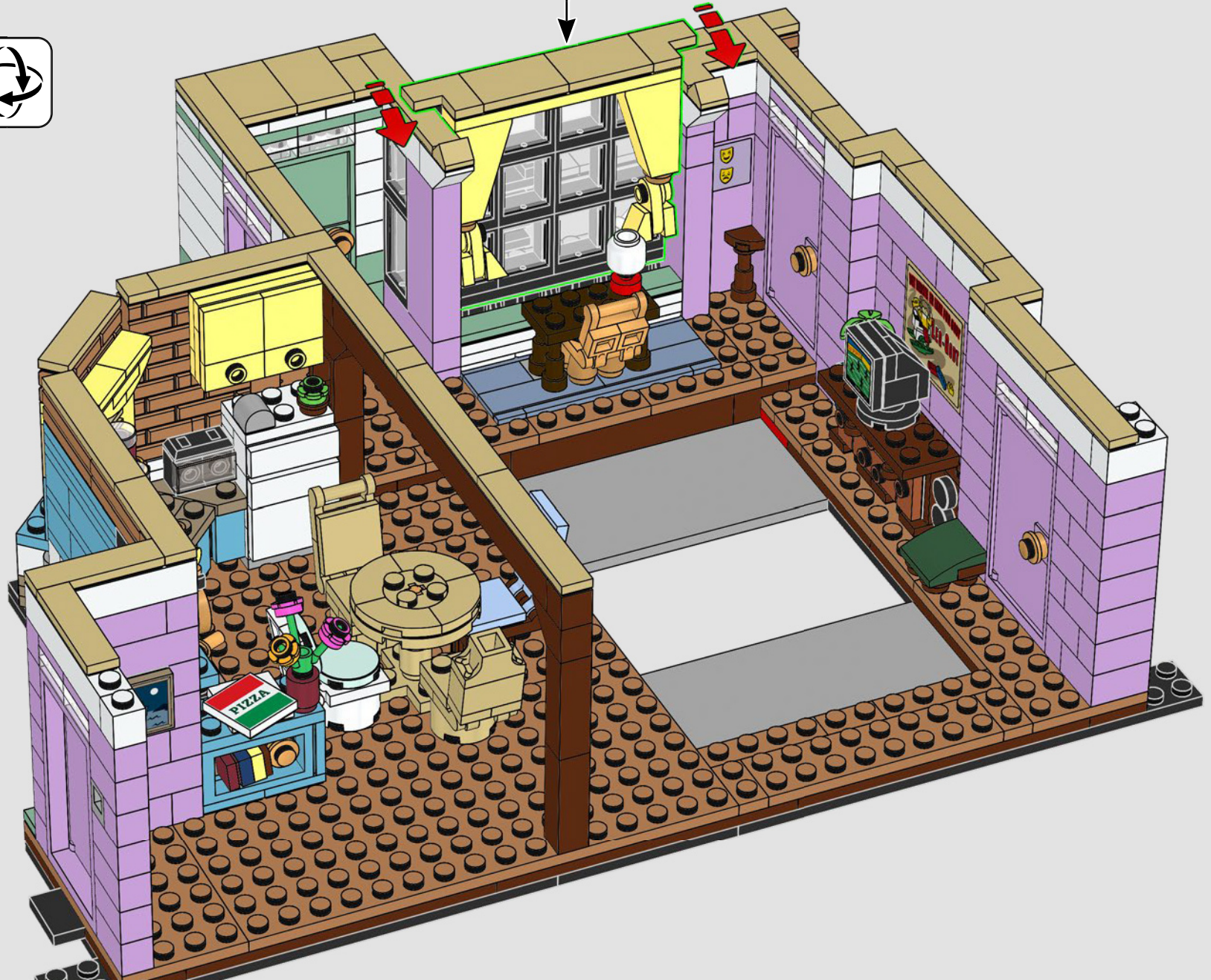



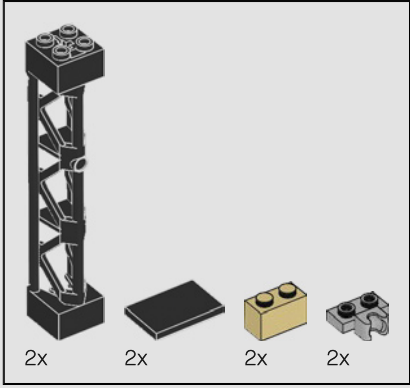
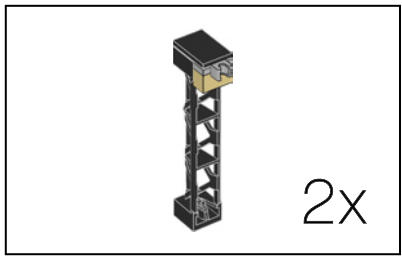

133

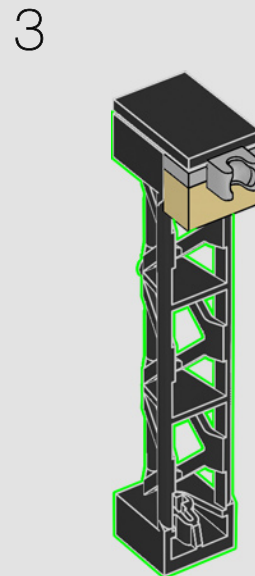
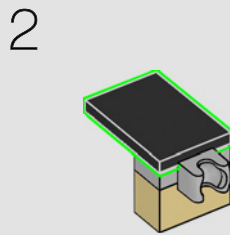
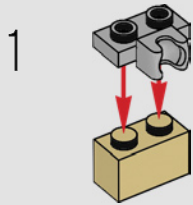





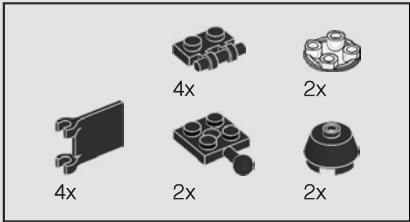
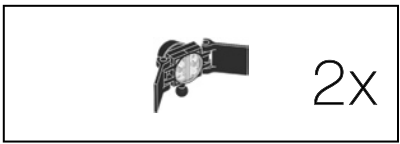

134

1



2

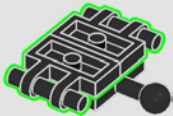

3



4

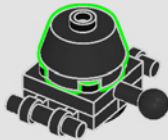

5

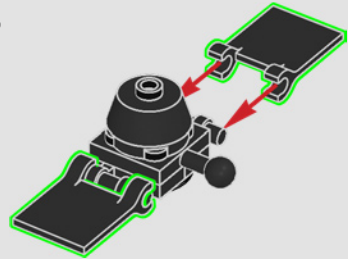

2x





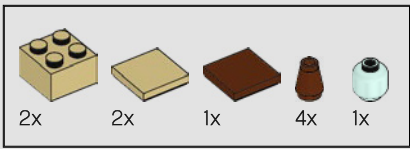

135

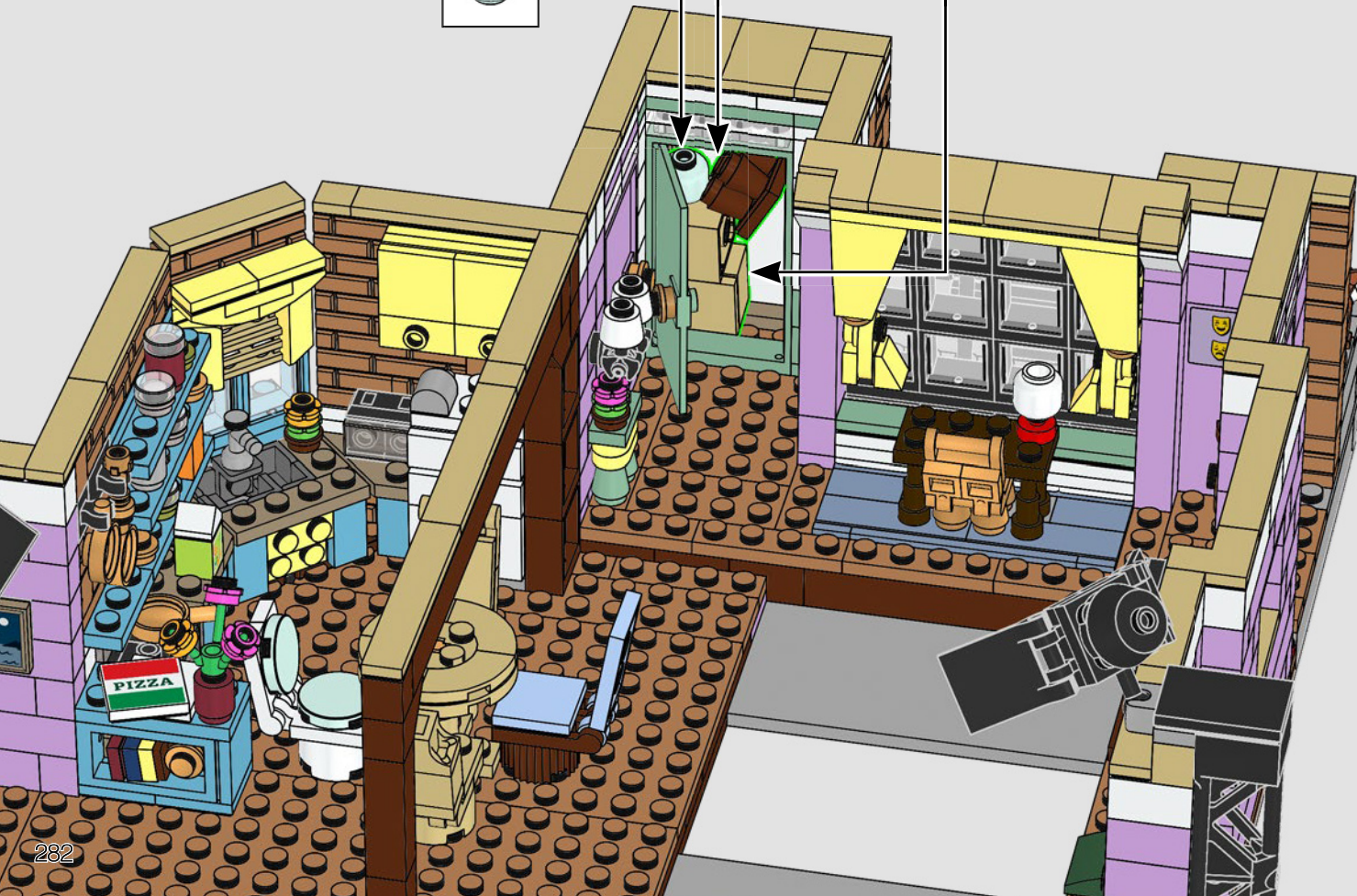
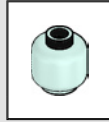
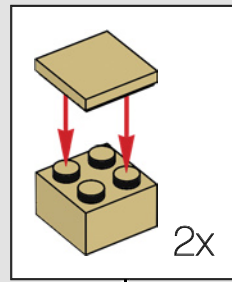
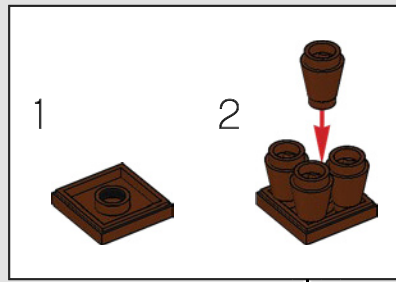

El armario, atiborrado de cacharros, es donde Monica escondía todo su desorden.





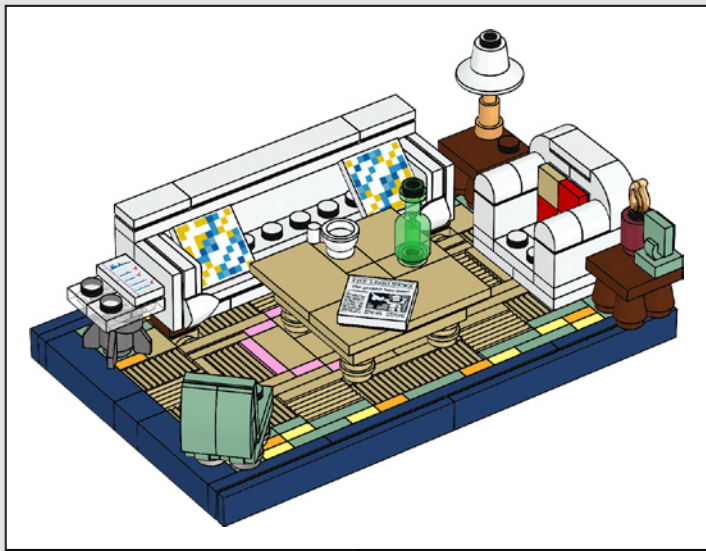

136





137



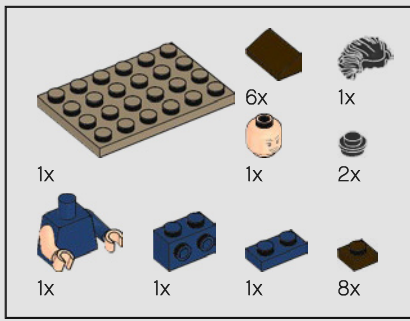

■ Conoce a Gladys, la horrenda escultura hecha por Phoebe. Ella la consideraba maravillosa, aunque a todos los demás les pareciera espantosa.



138

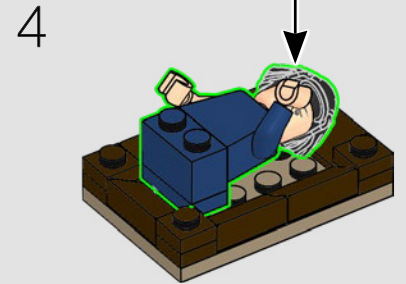
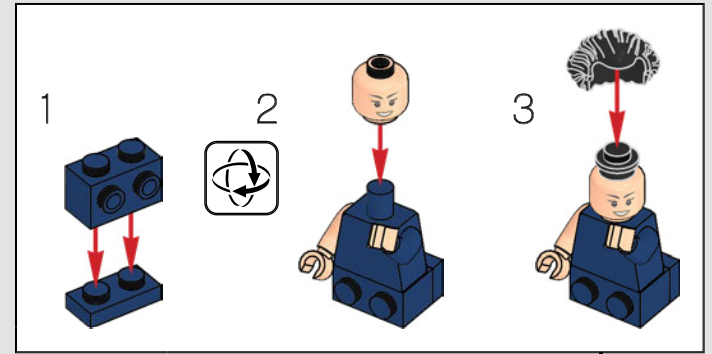
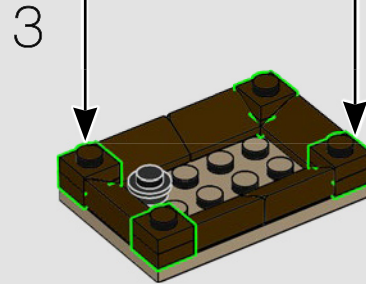
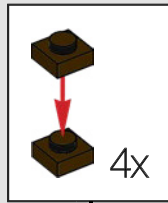
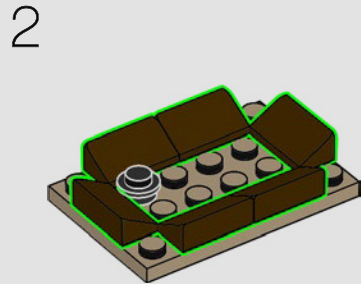
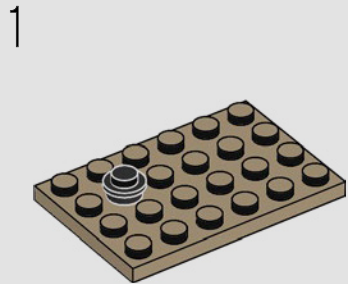



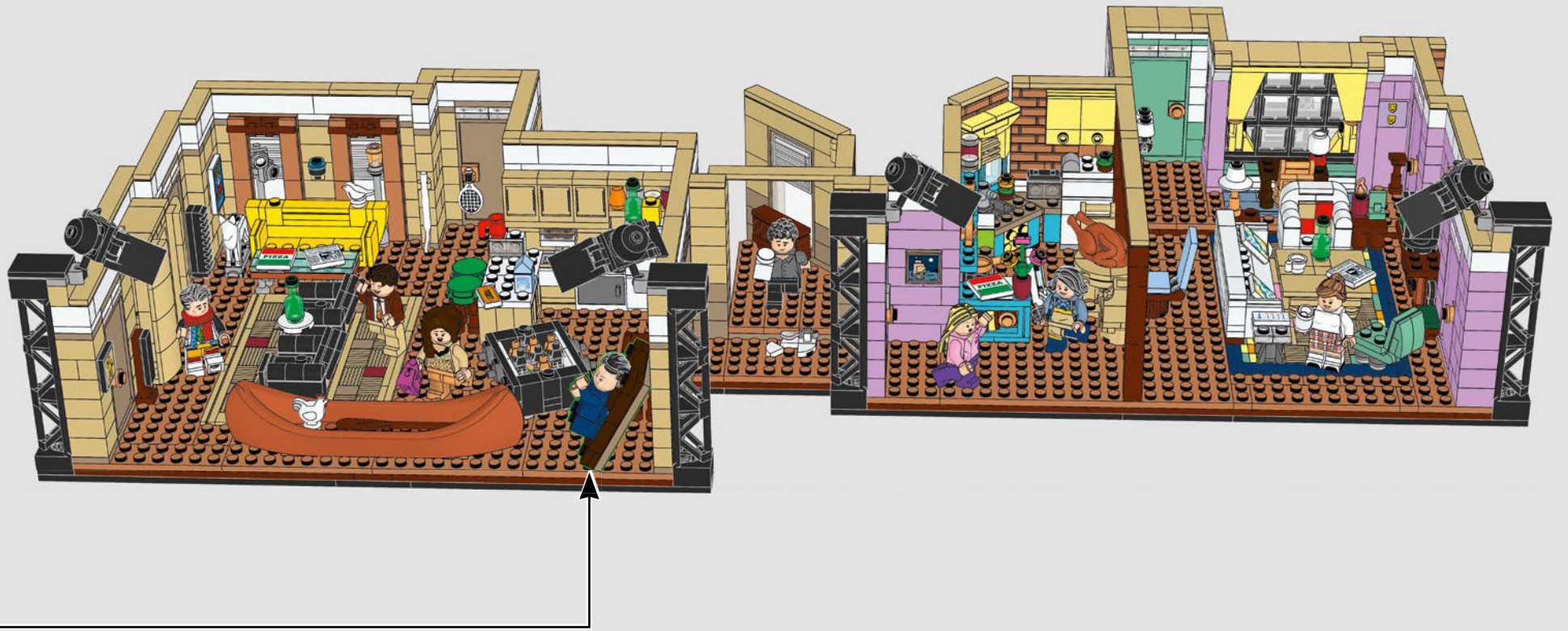



# FEEDBACK AND WIN



## FEEDBACK AND WIN

Your feedback will help shape the future development of this product series.

Please visit:

## FEEDBACK UND GEWINNEN

Dein Feedback trägt zur Weiterentwicklung dieser Produktreihe bei.

Geh auf:

## COMMENTEZ ET GAGNEZ

Vos commentaires nous aideront à concevoir les futurs produits de cette gamme.

Rendez-vous sur :

## COMENTA Y GANA

Tu opinión nos ayudará a dar forma al desarrollo de esta serie de productos en el futuro.

Visita:

## 反馈有奖

您的反馈将有助于我们在今后改进本系列产品。

请访问：

[LEGO.com/productfeedback](https://www.lego.com/productfeedback)

By completing, you will automatically enter a drawing to win a LEGO® set.

Terms & Conditions apply.

Durch Ausfüllen nimmst du automatisch an der Verlosung eines LEGO® Preises teil.

Es gelten die Teilnahmebedingungen.

En envoyant vos commentaires, vous serez automatiquement inscrit(e) à un tirage au sort qui vous permettra de remporter un prix LEGO®.

Offre soumise à conditions.

Al contestar, participarás automáticamente en el sorteo y podrás ganar un set LEGO®.

Sujeto a Términos y Condiciones.

完成我们的反馈调查，即可自动进入抽奖环节，赢取乐高®套装。

适用《条款和条件》。



1x 6276148	2x 654101	2x 6285777	2x 6361170	2x 6104805	1x 6360037	1x 6236423	9x 6221467	7x 6175367	1x 4113993	3x 4143005
1x 4518400	3x 6218841	10x 302301	8x 362201	2x 4560178	2x 6252969	2x 6313119	8x 6046924	11x 4550324	1x 4113993	1x 6299413
1x 6284572	10x 300501	6x 306901	9x 362301	10x 300901	4x 4179771	1x 6364438	4x 4185177	15x 4113233	4x 4114324	4x 302424
1x 6052312	2x 6046905	4x 6218823	3x 4558168	1x 663601	8x 4579260	2x 4124456	1x 4114084	1x 4201062	10x 4544139	2x 4624985
3x 6173141	1x 6063275	4x 6070327	1x 6256050	2x 379501	20x 4113915	4x 6092587	8x 6173057	18x 4113916	5x 4143409	1x 300524
1x 6253309	1x 474001	4x 6070698	1x 6021730	6x 346001	6x 6057517	3x 4205107	4x 6226565	1x 6146877	1x 6284574	4x 403224
1x 362601	1x 614301	6x 6097637	1x 6021730	1x 416201	17x 6232135	8x 4578107	2x 4114306	1x 6302268	1x 6215539	2x 6092583
1x 6263451	1x 6093053	2x 6290444	7x 302101	1x 416201	8x 6256080	2x 6335307	2x 4114077	1x 6146877	2x 307021	2x 6208753
1x 6235083	1x 6338819	2x 6175184	5x 302101	1x 416201	1x 4140562	17x 4114026	33x 4124455	1x 6302268	2x 307021	2x 306824
1x 302401	1x 6350040	1x 6126046	1x 6156667	1x 300801	1x 4140562	10x 4114026	10x 4162465	1x 4114309	1x 6298924	3x 6224666
1x 6348055	1x 6329599	2x 6218212	2x 6126046	2x 447701	1x 4125220	5x 4121921	5x 4121921	2x 4124067	5x 403221	2x 4247771
2x 407001	1x 6192534	2x 306801	1x 4619665	2x 447701	2x 4218749	1x 6061575	1x 6061575	2x 4124067	2x 302321	2x 302124
3x 6172366	1x 6192534	1x 302201	1x 300201	2x 4117070	2x 4218749	7x 6211966	7x 6211966	2x 4124067	1x 300121	2x 371024
4x 6258135	2x 366501	10x 242001	1x 300201	2x 4117070	40x 4655900	1x 6061575	1x 6061575	21x 4112982	1x 403221	2x 302124
2x 4558952	8x 300401	5x 235701	17x 301001	10x 4161734	1x 4107623	6x 6214334	6x 6214334	11x 4157277	1x 4113858	1x 243124
1x 6286834	1x 6058177	2x 4515364	6x 371001	2x 6230284	1x 6287623	3x 4217562	3x 4217562	1x 4157277	1x 4113858	1x 243124
2x 4558952	1x 6058177	2x 4515364	6x 371001	9x 4125253	36x 4109995	2x 4565387	2x 4565387	1x 4243824	1x 6130004	1x 300924





- 2x 6111685
- 1x 6262030
- 7x 6001824
- 2x 6231386
- 2x 6015449
- 13x 4528604
- 7x 4521914
- 8x 6310835
- 1x 4633881
- 5x 6310830
- 17x 4550168
- 4x 6344040
- 5x 6328307
- 1x 6035540
- 11x 4626904
- 4x 6001822
- 8x 6262970
- 2x 6038637
- 3x 4267874
- 1x 6015424
- 1x 4247151
- 7x 6156492
- 1x 6167894
- 4x 4184108
- 4x 4255413
- 3x 6345563
- 1x 6338823
- 1x 4528981
- 2x 6135606
- 4x 4502089
- 2x 4507080
- 4x 6250216
- 1x 6101285
- 2x 6134280
- 1x 6223913
- 8x 6099189
- 4x 6009656
- 1x 6348059
- 2x 6360112
- 18x 4655080
- 2x 6278553
- 2x 4616581
- 1x 6186823
- 1x 6133896
- 2x 6258387
- 1x 6346547
- 2x 4521947
- 3x 6192923
- 1x 6342692
- 4x 4539099
- 1x 4550169
- 2x 4541376
- 3x 6357747
- 1x 6172233
- 2x 6209681
- 11x 6073040
- 1x 6359662
- 1x 6284586
- 12x 4529242
- 10x 4216581
- 3x 4211242
- 6x 6348057
- 1x 6149677
- 8x 4221744
- 2x 4211288
- 2x 6177699
- 1x 4620075
- 2x 6201911
- 9x 6238874
- 1x 6174229
- 1x 6167879
- 2x 6153863
- 1x 6036503
- 2x 4223303
- 2x 6092590
- 5x 4211150
- 4x 4211151
- 3x 4595814
- 2x 4211222
- 13x 6310449
- 2x 6273865
- 1x 4271949
- 7x 4216695
- 2x 6196221
- 4x 6102975
- 2x 6116613
- 5x 4211189
- 2x 4216668
- 3x 4211190
- 1x 4211194
- 1x 4283660
- 7x 4211186
- 6x 4221590
- 2x 4609635
- 1x 4211247
- 4x 4263776
- 14x 4211211
- 1x 4217848
- 8x 4223683
- 3x 4211207
- 1x 4211214
- 3x 6096716
- 1x 6258989
- 2x 6170418
- 1x 6249246
- 2x 4211412
- 3x 6284071
- 2x 4529241
- 4x 4211525
- 1x 6168647
- 5x 4211503
- 1x 4211483
- 2x 6286223
- 2x 4211476
- 2x 6308012
- 3x 6262085
- 2x 4211415
- 2x 4558953
- 2x 4213567
- 1x 6311384
- 4x 6261375
- 4x 6043656
- 3x 6066097
- 2x 4211388
- 1x 4211398
- 1x 4211414
- 1x 6261353
- 2x 4211428
- 1x 4211429
- 1x 4211396
- 2x 4211636
- 2x 4211394
- 1x 4211549
- 1x 4211837
- 1x 4211392
- 1x 4211404
- 4x 4211521
- 1x 4211405

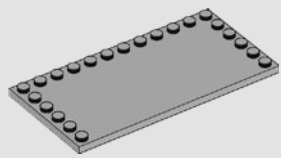

4x  
4211836

4x  
6271752

5x  
6025235

1x  
6225494

1x  
6331222

3x  
6221607

1x  
4210811

2x  
6284702

1x  
6228085

1x  
6162894

1x  
6360050

3x  
6209679

4x  
6031883

2x  
4654128

2x  
6002148

21x  
6058014

2x  
6296498

4x  
6296501

2x  
6296963

2x  
6296510

1x  
6346546

2x  
6195266

2x  
6061201

2x  
6296507

2x  
6222971

2x  
6286832

1x  
6316265

3x  
6296521

3x  
6248756

2x  
6296524

1x  
6248761

1x  
4586410

1x  
6338817

1x  
6338820

1x  
6343013

1x  
6338824

1x  
6338826

1x  
6338828

1x  
6338831

1x  
6162427

1x  
6347939

1x  
6347975

1x  
6347849

1x  
6347981

1x  
6348014

1x  
6347824

1x  
6347873

1x  
6347869

1x  
6003147

4x  
6335932

4x  
4529247

2x  
6190252

12x  
4523159

1x  
6262138

2x  
6284379

3x  
6138068

1x  
4512021

2x  
4538126

2x  
4585493

4x  
6109752

2x  
6287425

4x  
6092674

1x  
6248486

3x  
6097419

5x  
4649741

1x  
6286836

3x  
6060857

2x  
4619513

1x  
6070757

2x  
6036238

2x  
4655256

2x  
4625036

3x  
6146926

1x  
6093529

8x  
6194729

1x  
6223146

6x  
6127366

1x  
6348012

4x  
4538950

1x  
6226792

20x  
6057986

6x  
6215606

1x  
6093260

6x  
6218360

21x  
4656783

2x  
6102994

4x  
6056383

2x  
6177535

8x  
6102998

20x  
6055309

15x  
6167700

12x  
6093494

4x  
6295464

6x  
6226644

1x  
6346548

24x  
6218145

2x  
6272111

1x  
6196796

7x  
4633691

2x  
6215447

1x  
4624615

1x  
6175870

2x  
6096948

1x  
6125776

23x  
6097053

15x  
6099190

31x  
6099352

4x  
6290505

4x  
6344038

1x  
6273909

2x  
6258990

4x  
6217492

3x  
6217498

16x  
6097870

14x  
6097867

4x  
6344416



Customer Service  
Kundenservice  
Service Consommateurs  
Servicio Al Consumidor

LEGO.com/service or dial



: 00800 5346 5555

: 1-800-422-5346



LEGO and the LEGO logo are trademarks of the LEGO Group. ©2021 The LEGO Group.



FRIENDS and all related characters and elements © & ™ Warner Bros.  
Entertainment Inc. WB SHIELD: © & ™ WBEI. (s21)