



F.R.I.E.N.D.S

THE TELEVISION SERIES

Booklet available in English on
Livret disponible en français sur
Folleto disponible en español en

LEGO.com/service/buildinginstructions



APTS 19 & 20 NEW YORK CITY, NY

From the purple walls of Monica's living room, to Chandler and Joey's reclining TV chairs; If you're a fan of *Friends*, then you'll feel right at home with this latest LEGO® homage to your favorite television series. As well as capturing the iconic decor of the two apartments and the connecting hallway, this set is packed with details and references to classic moments from the show.

LES APPARTEMENTS 19 ET 20 NEW YORK, NY

Des murs violets du salon de Monica aux fauteuils inclinables placés devant la télé de Chandler et de Joey, si vous êtes amateur de *Friends*, vous vous sentirez comme chez vous avec ce nouvel hommage LEGO® à votre série télévisée préférée. En plus de capturer le décor emblématique des deux appartements et du couloir communicant, cet ensemble déborde de détails et de références aux moments classiques de l'émission.

DEPARTAMENTOS 19 Y 20 CIUDAD DE NUEVA YORK (NUEVA YORK)

Desde las paredes púrpura de la sala de Monica o los sillones reclinables para ver el televisor de Chandler y Joey, cada elemento de este homenaje a tu serie de televisión favorita, el más reciente de LEGO®, te hará sentir como en casa si eres un verdadero fan de *Friends*. Además de capturar la inconfundible decoración de los dos departamentos y del recibidor que los conecta, este set está repleto de detalles y referencias a momentos inolvidables del programa.







CHANDLER & JOEY'S APARTMENT

Compared with the girls' apartment across the hall, Chandler and Joey's apartment is smaller, messier and the perfect living space for two young bachelors living in New York's Manhattan. Though all the main characters of the show live in the apartment at some point, all the fixtures and fittings here are from the classic Chandler and Joey period.

L'APPARTEMENT DE CHANDLER ET DE JOEY

L'appartement de Chandler et de Joey est plus petit et plus désordonné que celui des filles de l'autre côté du couloir, et constitue un espace de vie parfait pour deux jeunes célibataires vivant à Manhattan, New York. Bien que tous les personnages principaux de l'émission vivent dans l'appartement à un moment ou à un autre, l'aménagement et les accessoires sont basés sur la période classique de Chandler et de Joey.

DEPARTAMENTO DE CHANDLER Y JOEY

En comparación con el departamento de las chicas, ubicado al otro lado del pasillo, el departamento de Chandler y Joey es más pequeño, está más desordenado y representa el hogar ideal para dos jóvenes solteros que viven en Manhattan, el corazón de Nueva York. Aunque todos los personajes principales del programa vivieron en ese departamento en algún momento, los accesorios del set corresponden al clásico período en el que Chandler y Joey eran sus felices moradores.

MONICA & RACHEL'S APARTMENT

📍 Located in New York's Greenwich Village and originally Ross and Monica's grandmother's apartment, Monica & Rachel's living room and open-plan kitchen is an eclectic mix of bold colors and cluttered furniture – a stark contrast to the freakishly neat nature of Monica herself!

L'APPARTEMENT DE MONICA ET DE RACHEL

📍 Situé dans le quartier Greenwich Village de New York, cet appartement était à l'origine celui de la grand-mère de Ross et de Monica. Le salon et la cuisine à aire ouverte de Monica et de Rachel sont un mélange éclectique de couleurs audacieuses et de meubles encombrés – un contraste frappant avec la nature incroyablement soignée de Monica !

DEPARTAMENTO DE MONICA Y RACHEL

📍 Ubicado en Greenwich Village, el vecindario de Nueva York, y antiguo hogar de la abuela de Ross y Monica, el departamento de Monica y Rachel, con su enorme sala y cocina abierta, es una mezcla ecléctica de colores llamativos y muebles sobrecargados de accesorios: ¡todo lo opuesto al carácter obsesivamente ordenado de Monica!

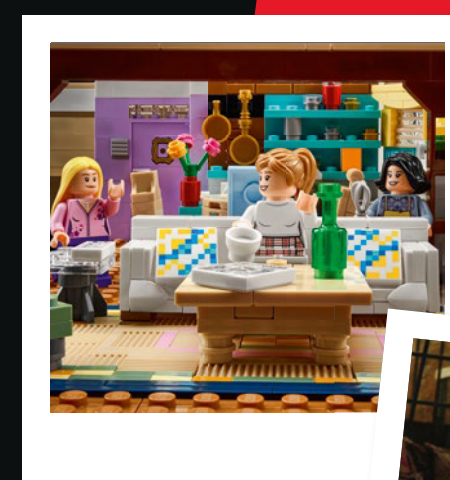

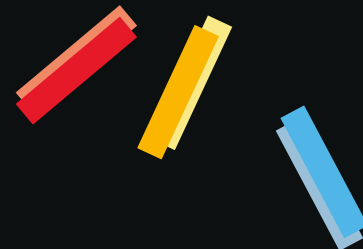

THE HALLWAY

● The small space between the two apartments and the location for the famous scene where Chandler and Rachel fight over a dropped piece of cheesecake and eat it off the floor, with Joey joining in!

LE COULOIR

● Le petit espace entre les deux appartements et l'emplacement de la célèbre scène où Chandler et Rachel se disputent un morceau de gâteau au fromage tombé par terre et le mangent à même le sol, avec Joey qui se joint à eux !

EL RECIBIDOR

● El pequeño espacio que separa ambos departamentos fue el escenario del famoso episodio en el que Chandler y Rachel pelean por un trozo de pastel que cae al suelo, terminan comiéndolo de allí, ¡y Joey se une posteriormente al festín!



FROM THE DESIGNER

🔴 I wasn't that familiar with the show when I started working on the model, so actually the greatest joy of this set for me was getting to talk to all the fans of the show who I work with, getting to hear about their favorite moments from the show... people could just go on and on and laugh and laugh remembering so many things. I hope that this set brings that same joy to everyone else who builds it.

MOT DU CONCEPTEUR

💡 Je n'étais pas très familier avec l'émission quand j'ai commencé à travailler sur le modèle, donc la plus grande joie de cet ensemble pour moi a été de parler à tous les amateurs de l'émission avec qui je travaille, d'apprendre leurs moments préférés... Les gens pouvaient en parler longuement et rire alors que des moments cocasses leur revenaient à l'esprit. J'espère que cet ensemble apportera cette même joie à tous ceux qui le construiront.

NOTAS DEL DISEÑADOR

🟡 No sabía mucho del programa cuando comencé a trabajar en el modelo. Por eso, lo que más disfruté de este set fue hablar con los fans del programa con quienes trabajo y escucharlos relatar sus momentos favoritos de este... Podían contar una anécdota tras otra y reír una y otra vez recordando incontables pasajes divertidos. Espero que el set traiga la misma alegría a todos los que lo construyan.

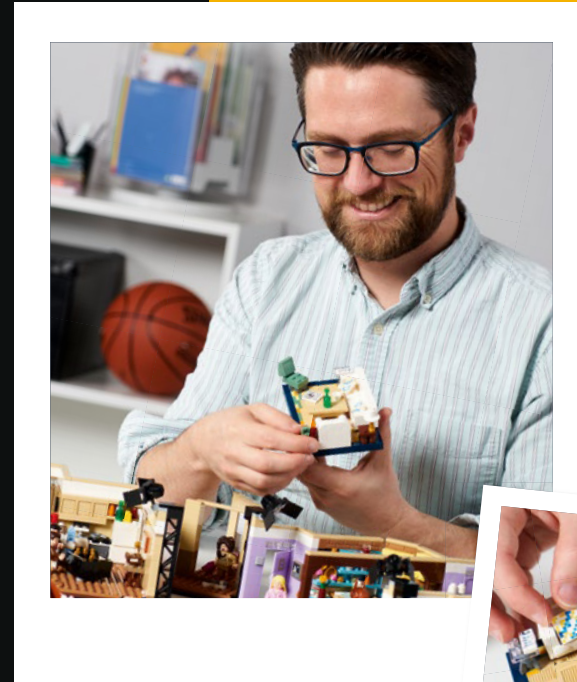

THE CHARACTERS

There are seven minifigures in the set, including all the main characters plus Chandler's long-time on-off girlfriend with that very distinctive voice, Janice Hosenstein.

LOS PERSONAJES

El set incluye siete minifiguras: las de los seis personajes principales y la de Janice Hosenstein, eterna pareja intermitente de Chandler con una voz muy peculiar.



LES PERSONNAGES

L'ensemble comprend sept figurines, incluant tous les personnages principaux ainsi que la petite amie de longue date de Chandler à la voix très distinctive, Janice Hosenstein.



ROSS GELLER

S5-E11:
"The One with All the Resolutions"
Ross shows off his leather pants

S5-E11 :
« Celui qui prenait de bonnes résolutions »
Ross exhibe son pantalon en cuir.

T5-E11:
"Los propósitos de Año Nuevo"
Ross presume sus pantalones de cuero.



MONICA GELLER
S7-E9:
"The One with All the Candy"
Monica makes candy for the neighbors.

S7-E9 :
« Celui qui offrait un vélo »
Monica fait des bonbons pour les voisins.

T7-E9:
"Los dulces de Monica"
Monica hace caramelos para los vecinos.



RACHEL GREEN
S1-E19:
"The One Where the Monkey Gets Away"
Rachel loses a monkey!

S1-E19 :
« Celui qui a perdu son singe »
Rachel perd un singe !

T1-E19:
"El día que Marcel se fue"
¡Rachel pierde a un mono!





PHOEBE BUFFAY

S6-E7.:
"The One Where Phoebe Runs"
Phoebe is living with Rachel.

S6-E7 :
« Celui qui avait une jolie colocataire »
Phoebe vit avec Rachel.

T6-E7:
"La forma de correr de Phoebe"
Phoebe vive con Rachel.



JOEY TRIBBIANI

S3-E2.:
"The One Where No One's Ready"
Joey puts on all of Chandler's clothes.

S3-E2 :
« Celui qui a du mal à se préparer »
Joey enfle tous les vêtements de Chandler.

T3-E2:
"Cuando nadie está listo"
Joey se pone toda la ropa de Chandler.



CHANDLER BING

S4-E2.:
"The One with the Cat"
Where Chandler doesn't turn and slide!

S4-E2 :
« Celui qui ne voyait qu'un chat »
Chandler ne tourne et ne glisse pas !

T4-E2:
"El gato"
¡Cuando Chandler olvida girar y salir!



JANICE HOSENSTEIN

S7-E7.:
"The One with Ross's Library Book"
Janice invites herself to Chandler and Monica's wedding.

S7-E7 :
« Celui qui avait un livre à la bibliothèque »
Janice s'invite au mariage de Chandler et de Monica.

T7-E7:
"El libro de la biblioteca"
Janice se autoinvita a la boda de Chandler y Monica.





[LEGO.com/brickseparator](https://www.lego.com/brickseparator)

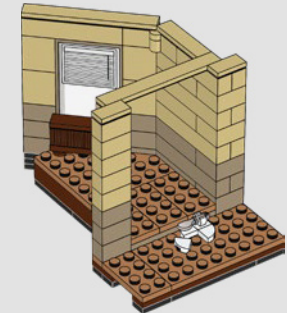
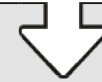
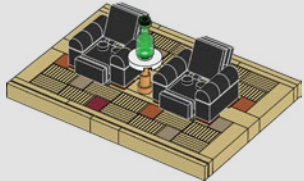



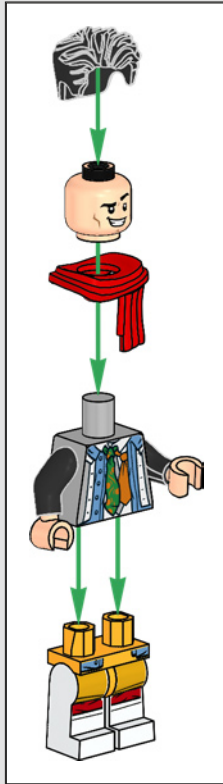
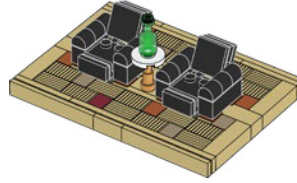

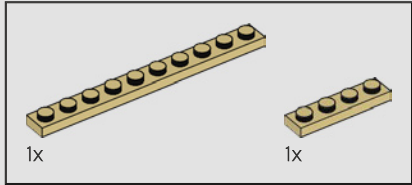
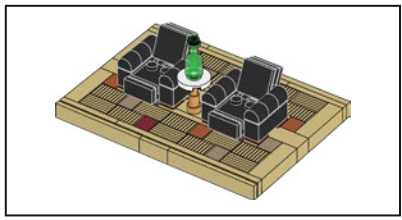

1

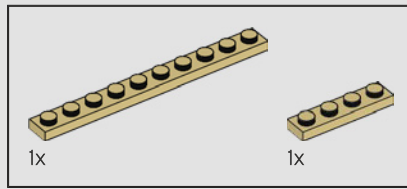
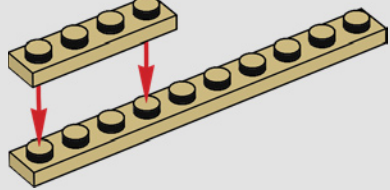

2

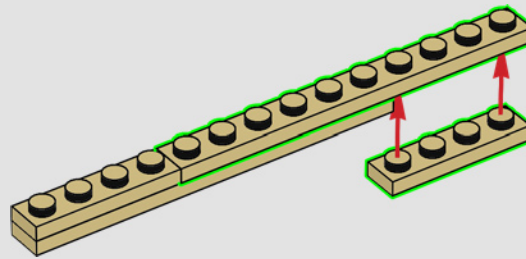

3

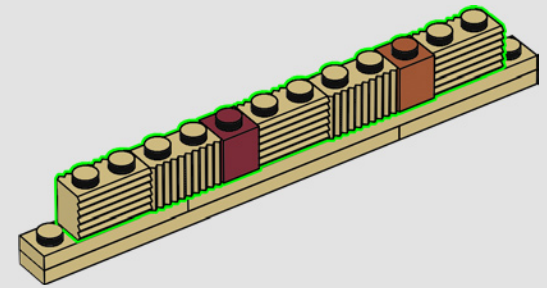

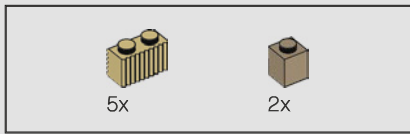

4

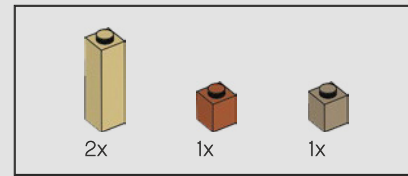
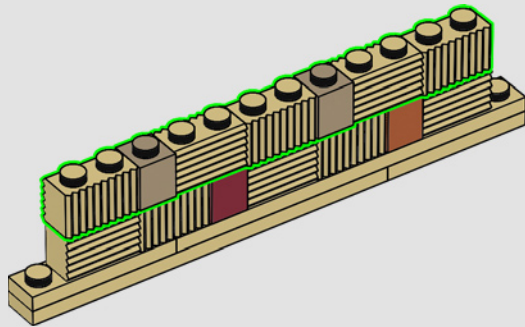

5

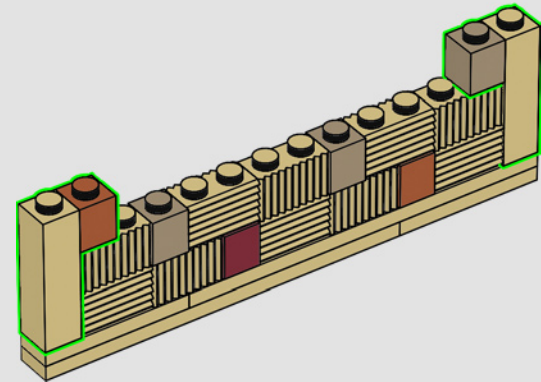

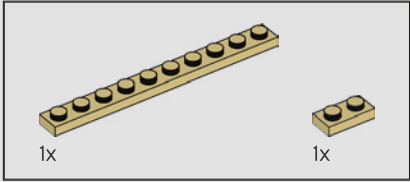
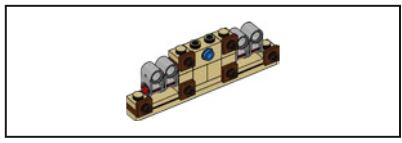

6

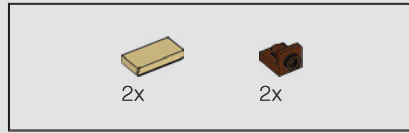
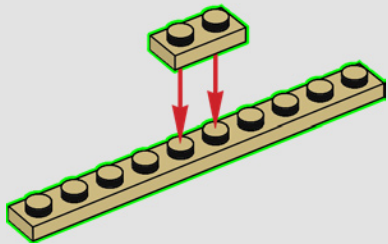

7

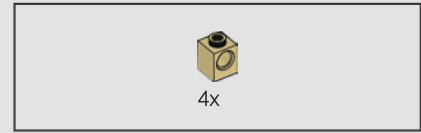
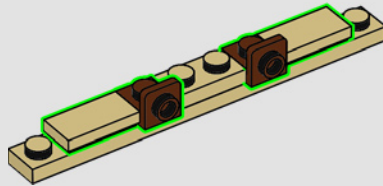

8

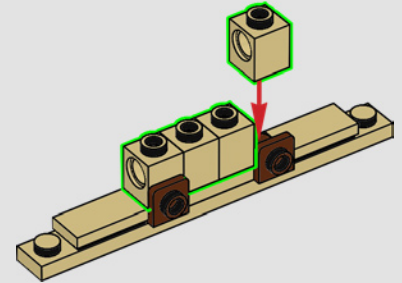

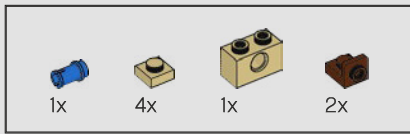

9

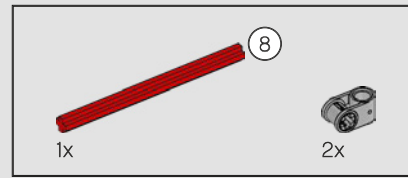
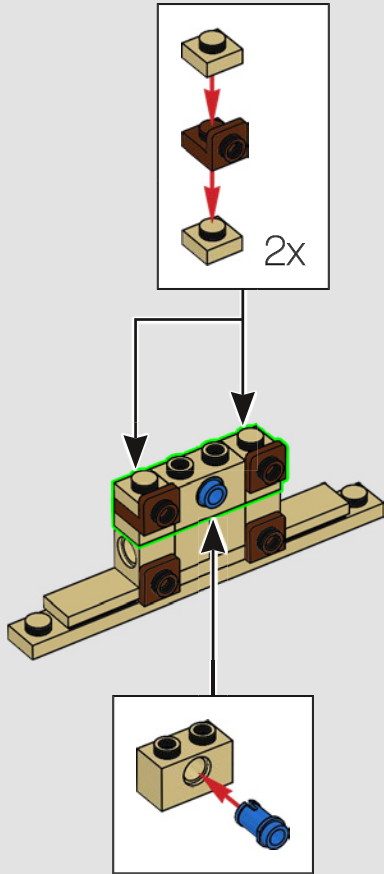

10

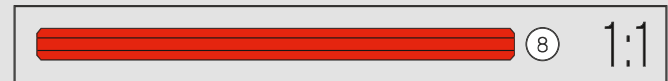
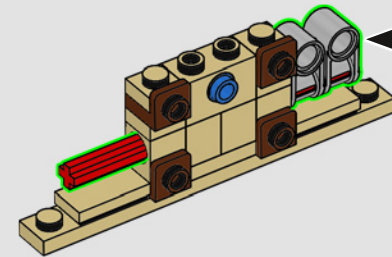
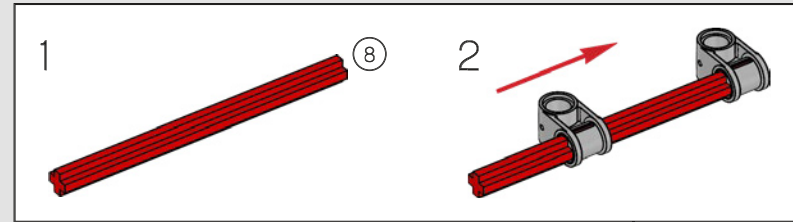



2x

11

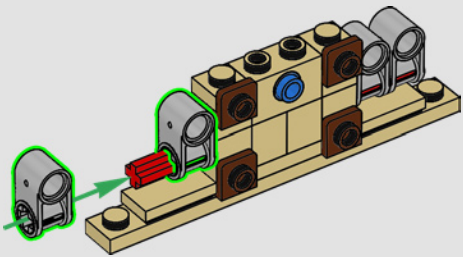

2x



2x

12

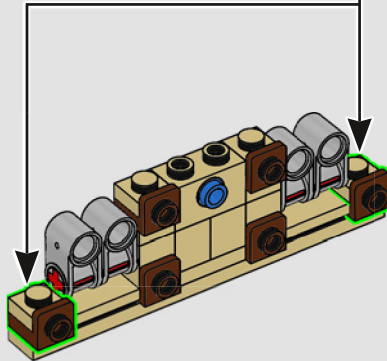
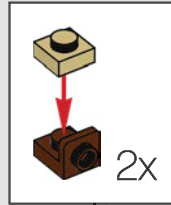

13

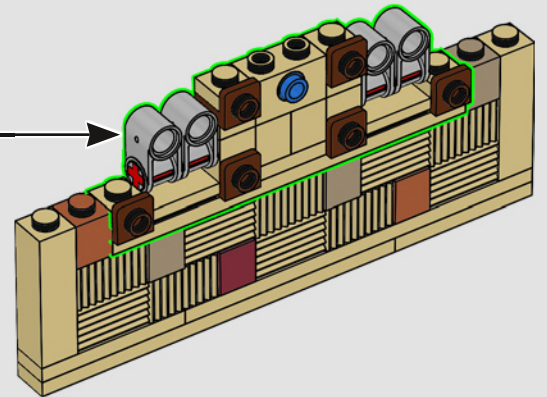

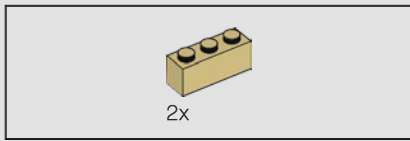

14

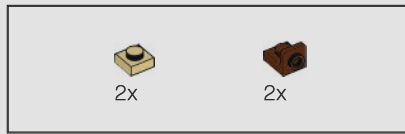
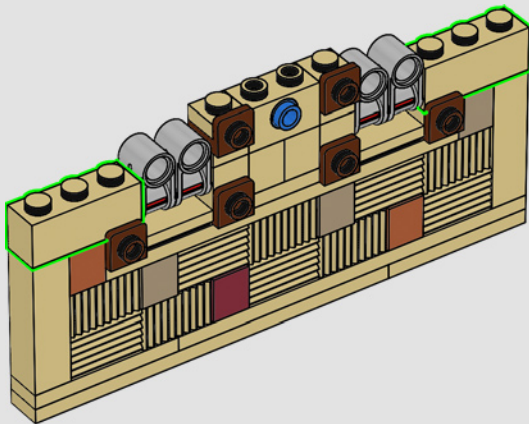

15

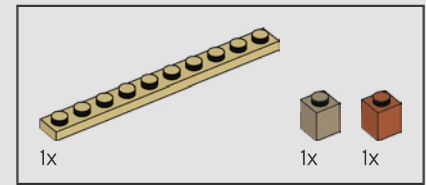
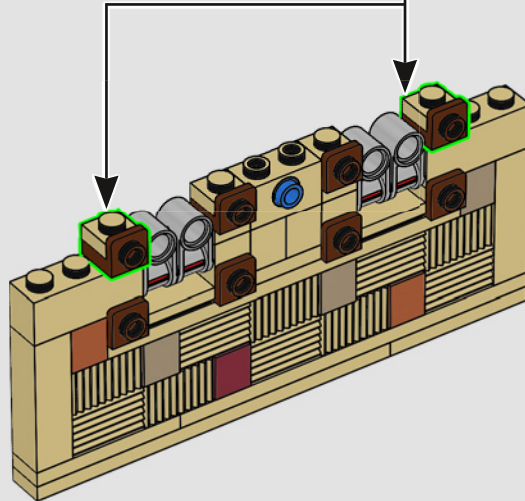
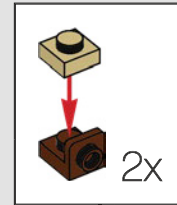

16

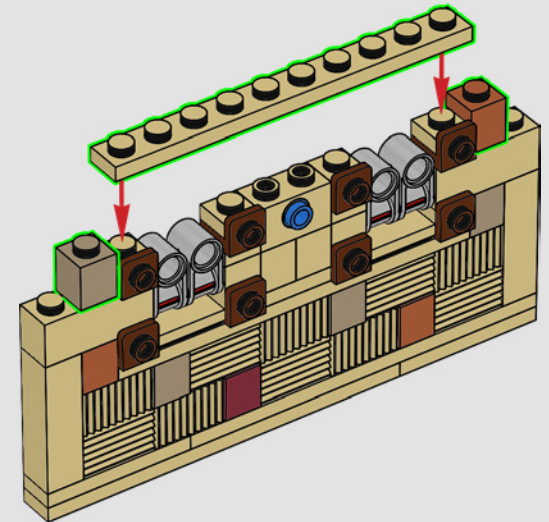

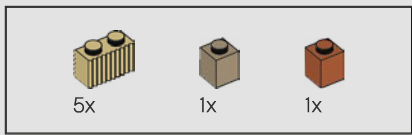

17

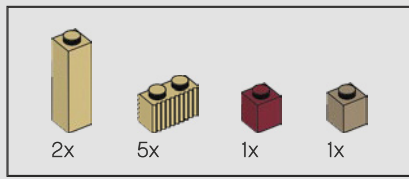
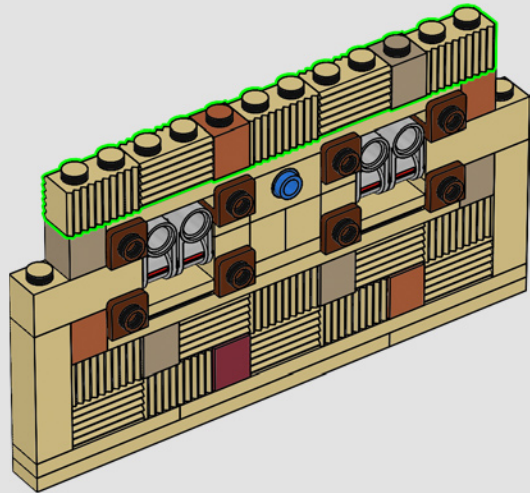

18

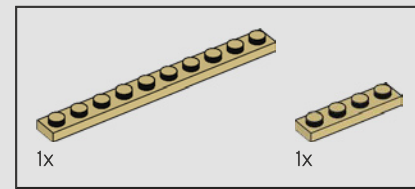
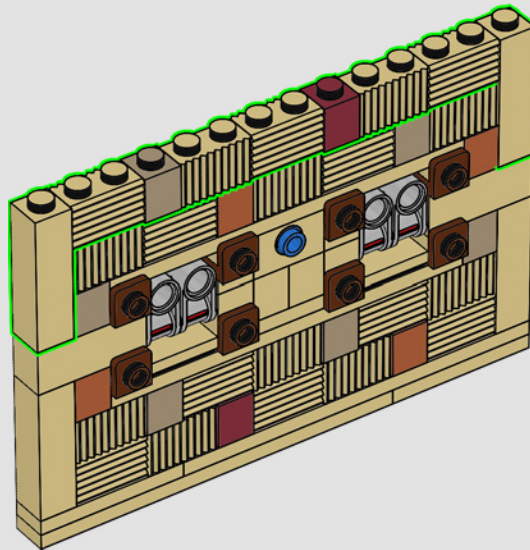

19

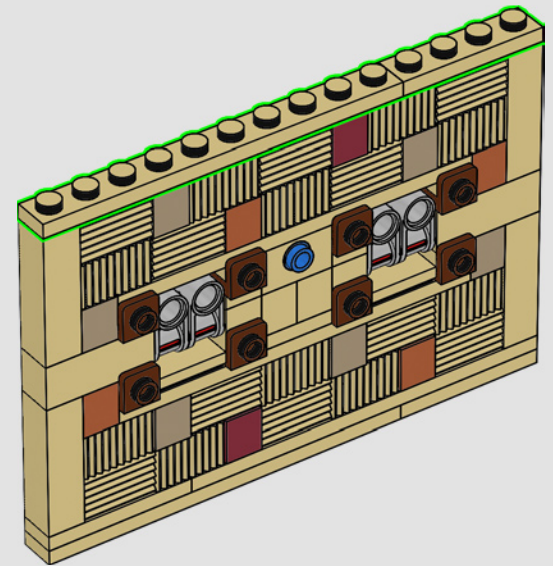

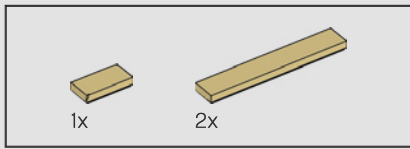

20

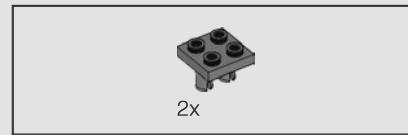
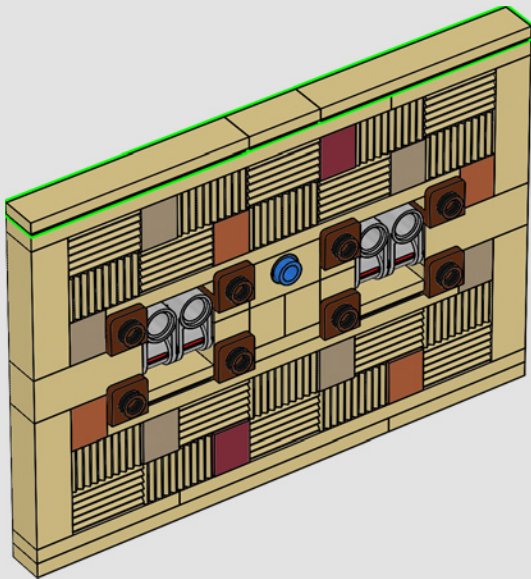

21

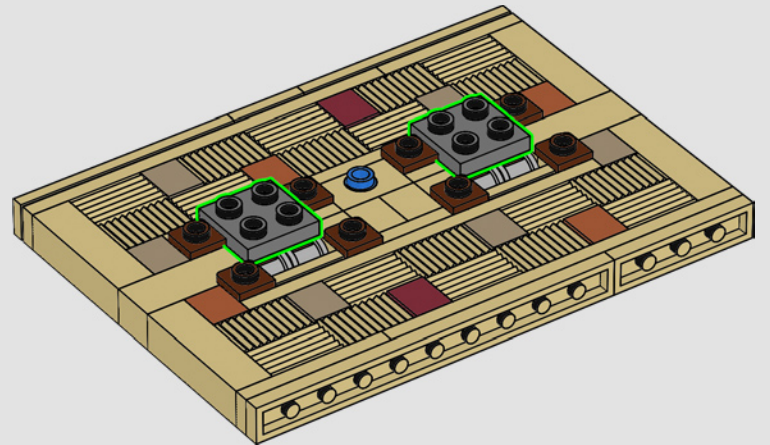

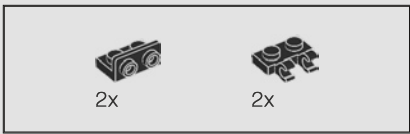

22

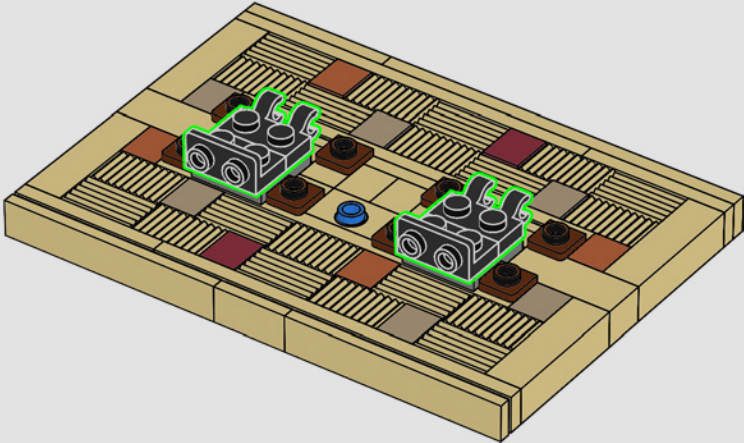

23

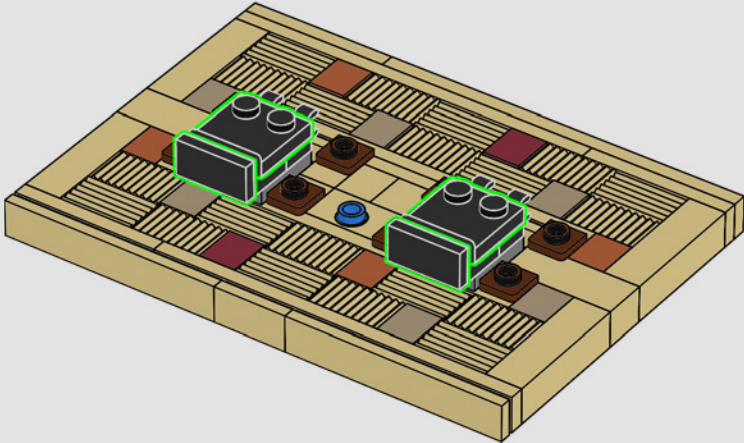

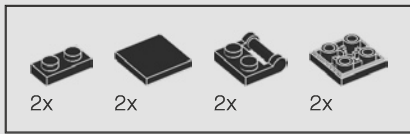

24

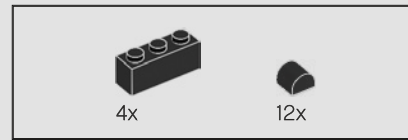
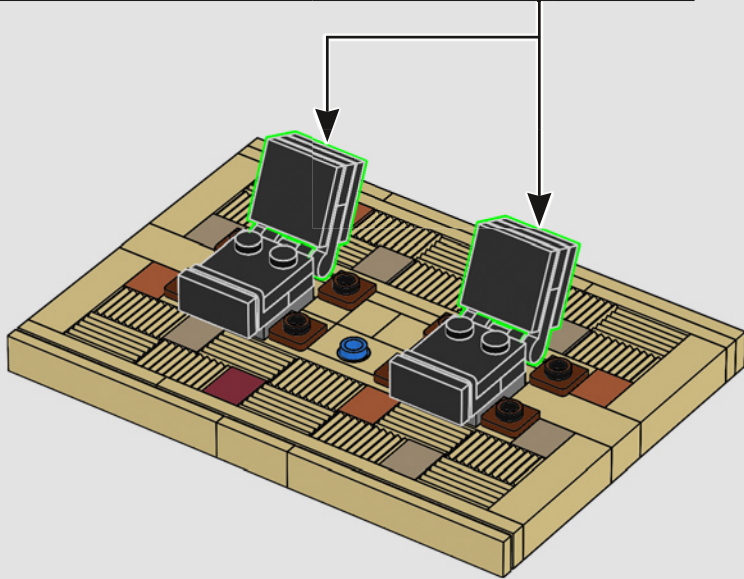
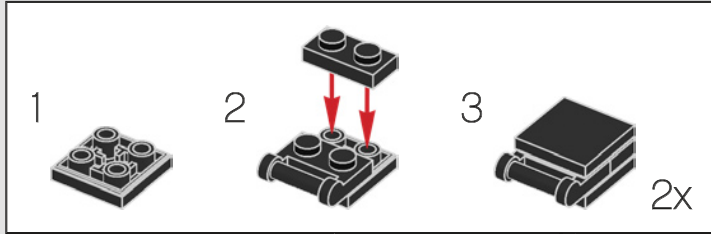

25

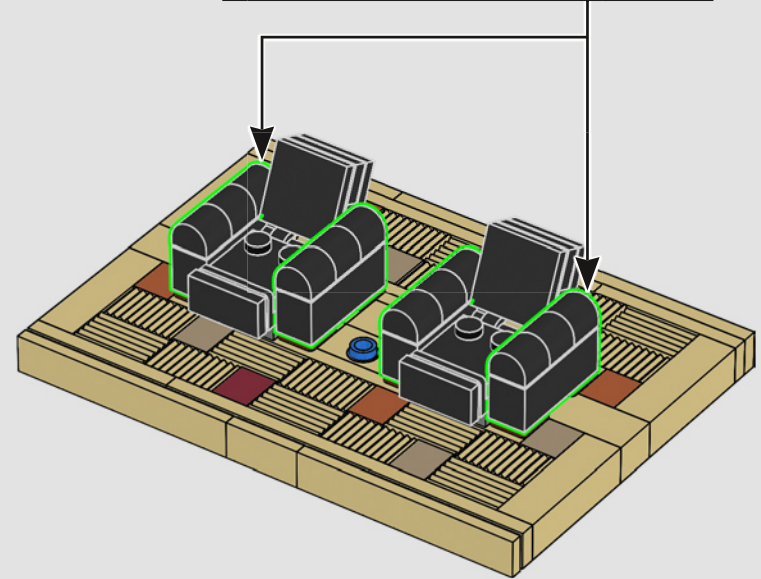
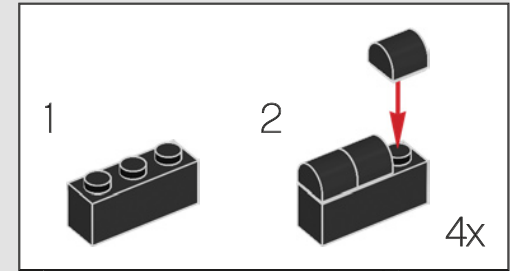

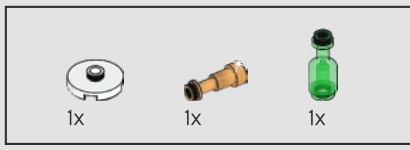

26

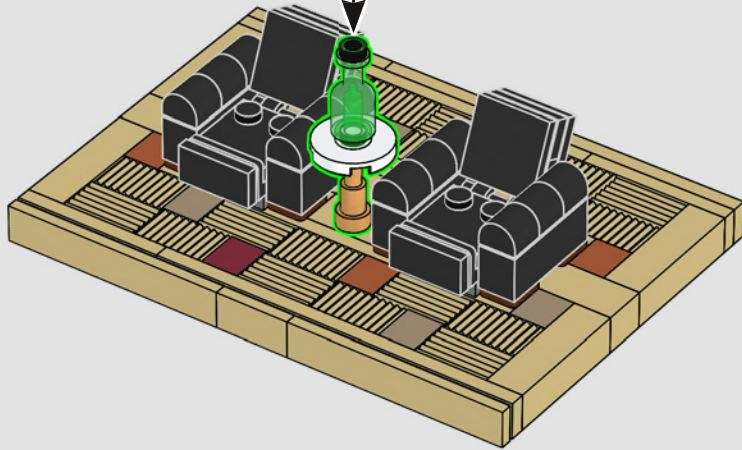
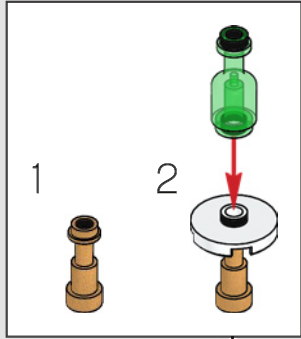

● The reclining chairs lean back at the same time, from that iconic moment when the guys first get the chairs and recline together.

● Les fauteuils inclinables se penchent en arrière en même temps, pour reproduire ce moment emblématique où les gars se procurent les fauteuils et les inclinent ensemble.

● Los sillones se reclinan al mismo tiempo por el inolvidable momento cuando ambos chicos recién los habían adquirido y deciden inclinar sus respaldos a la vez.



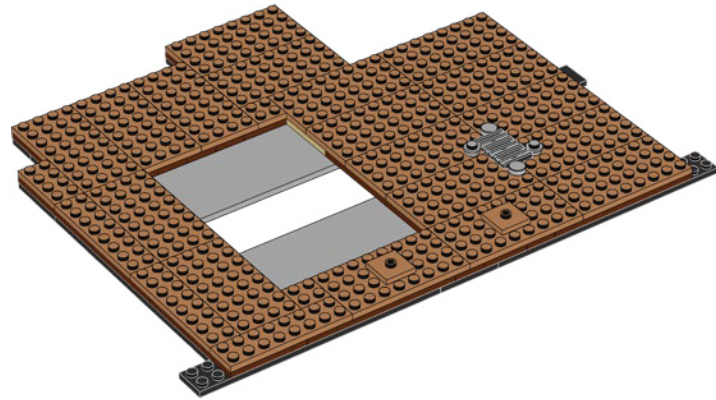

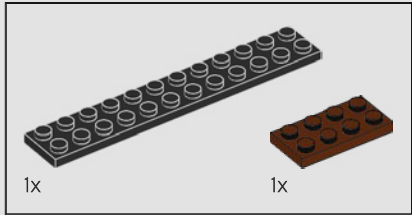
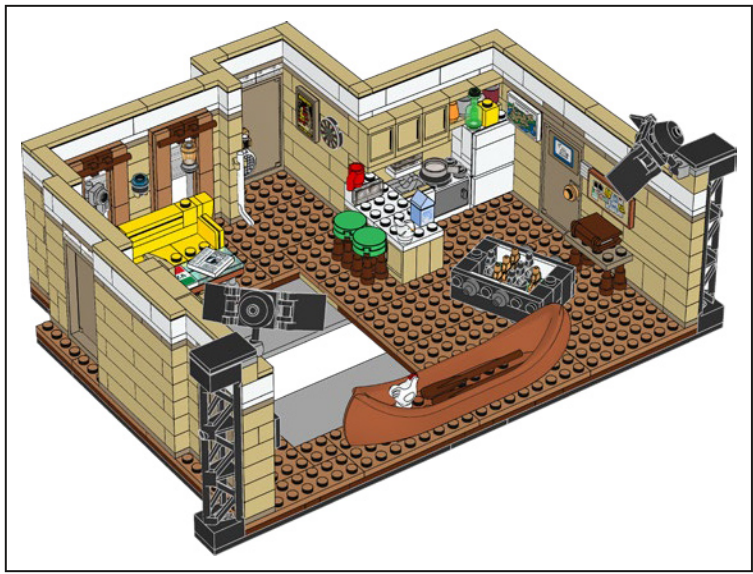

1

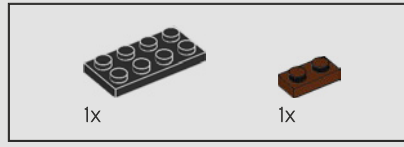
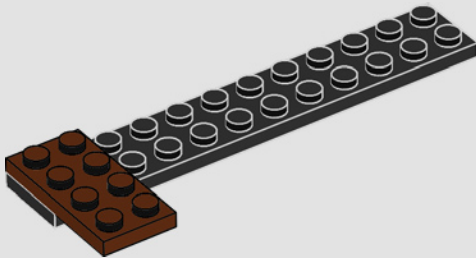

2

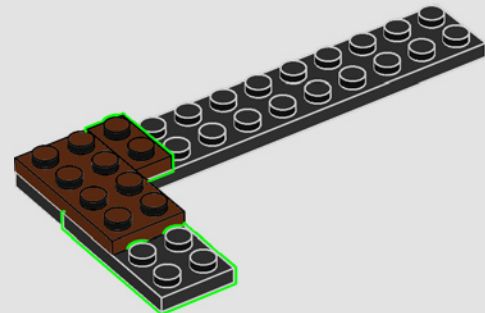

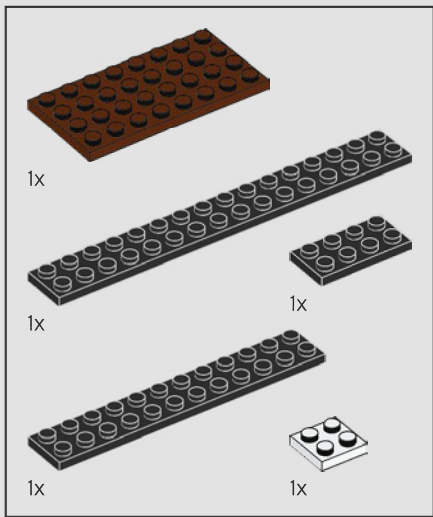

3

1

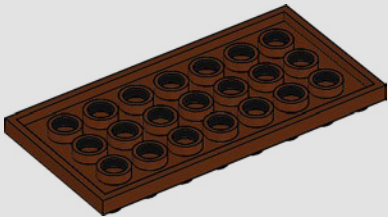

2

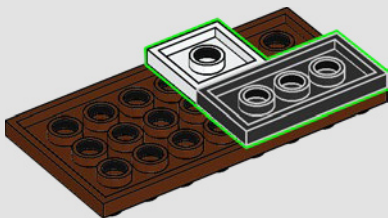

3

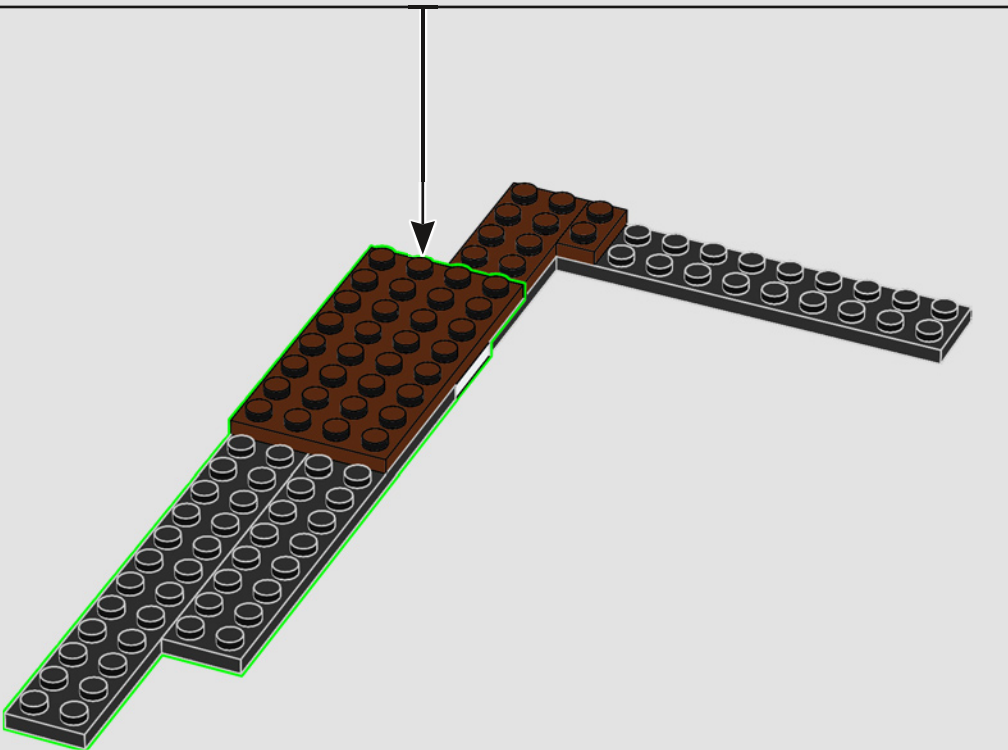
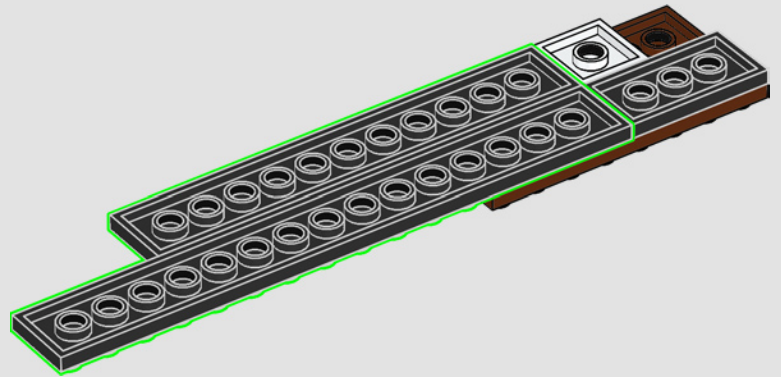

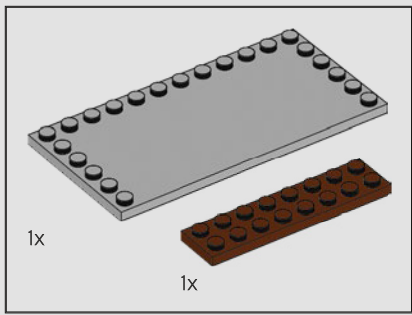

4

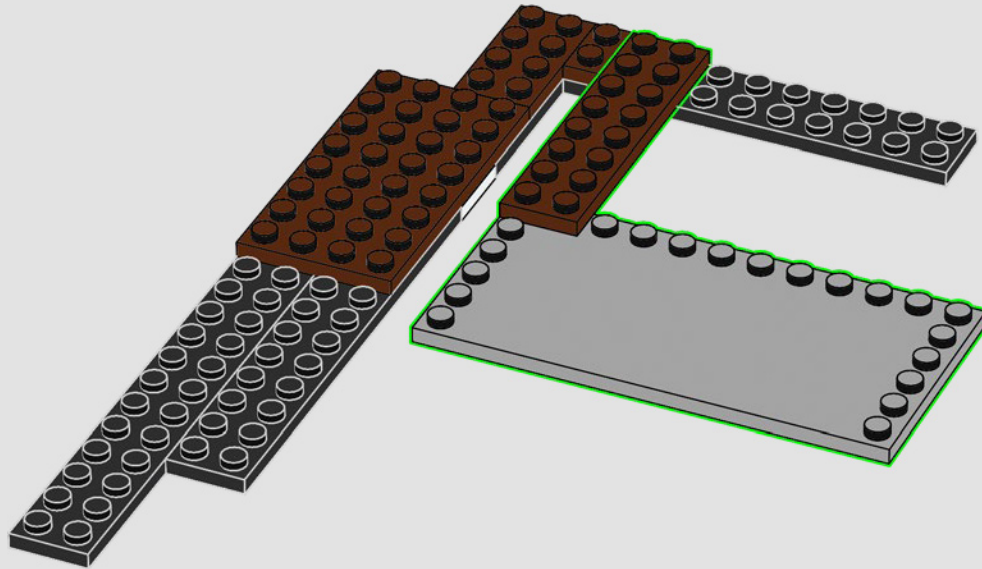

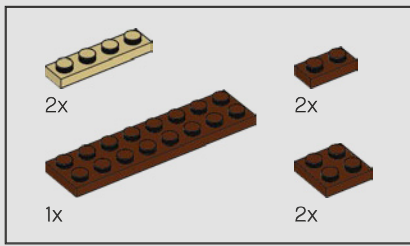

5

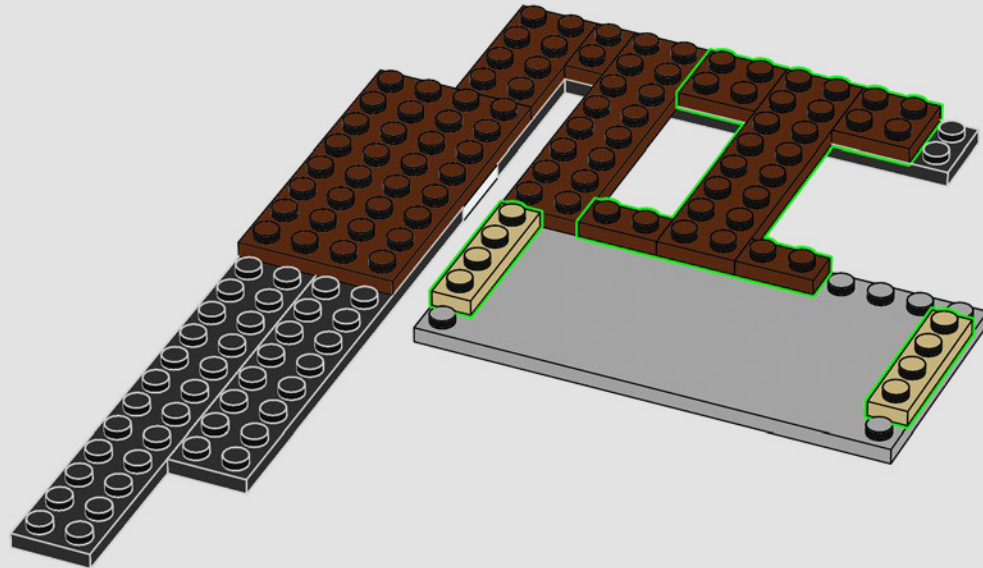

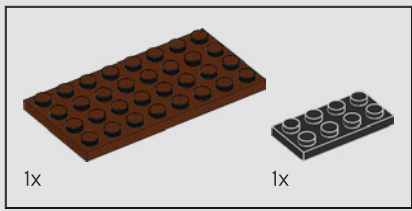

6

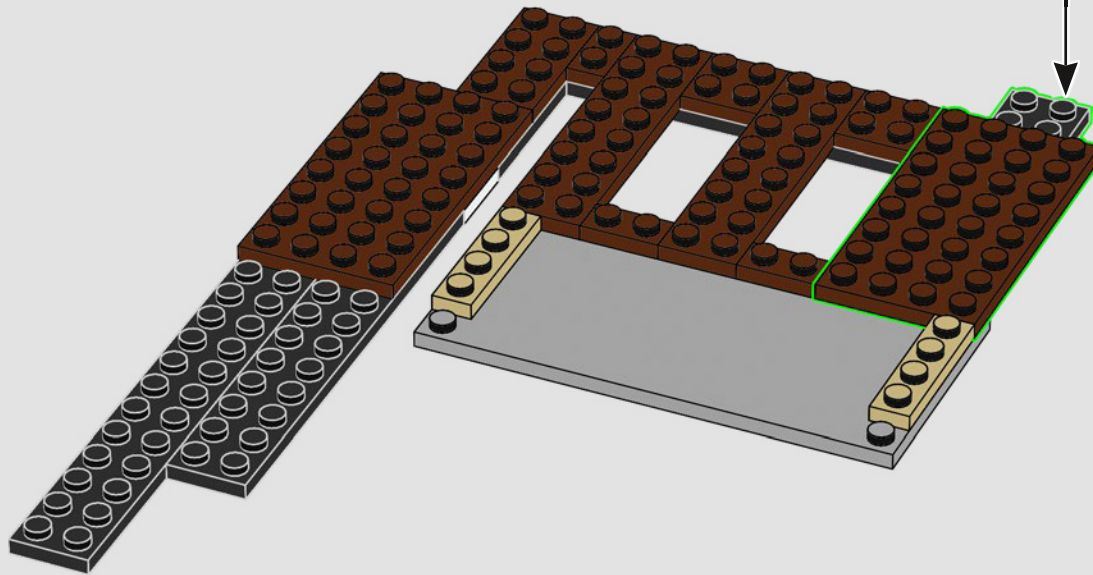
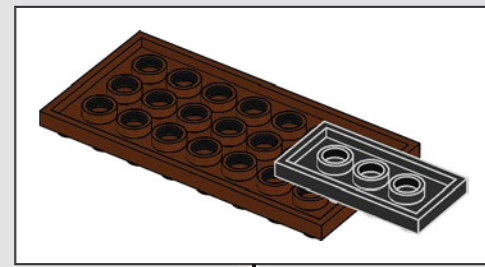

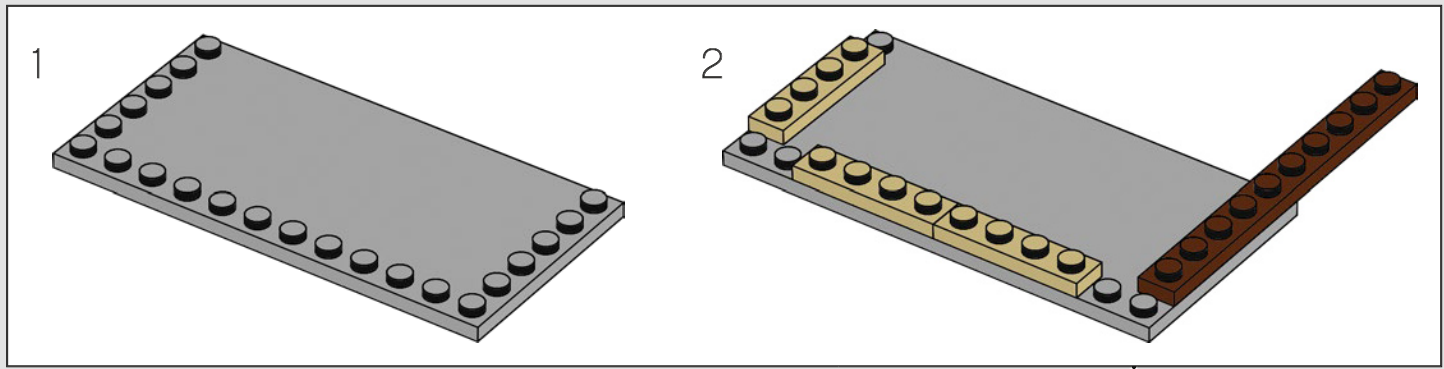
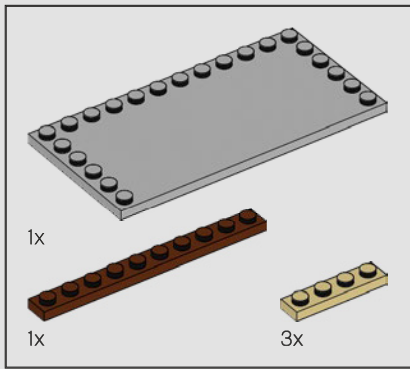

7

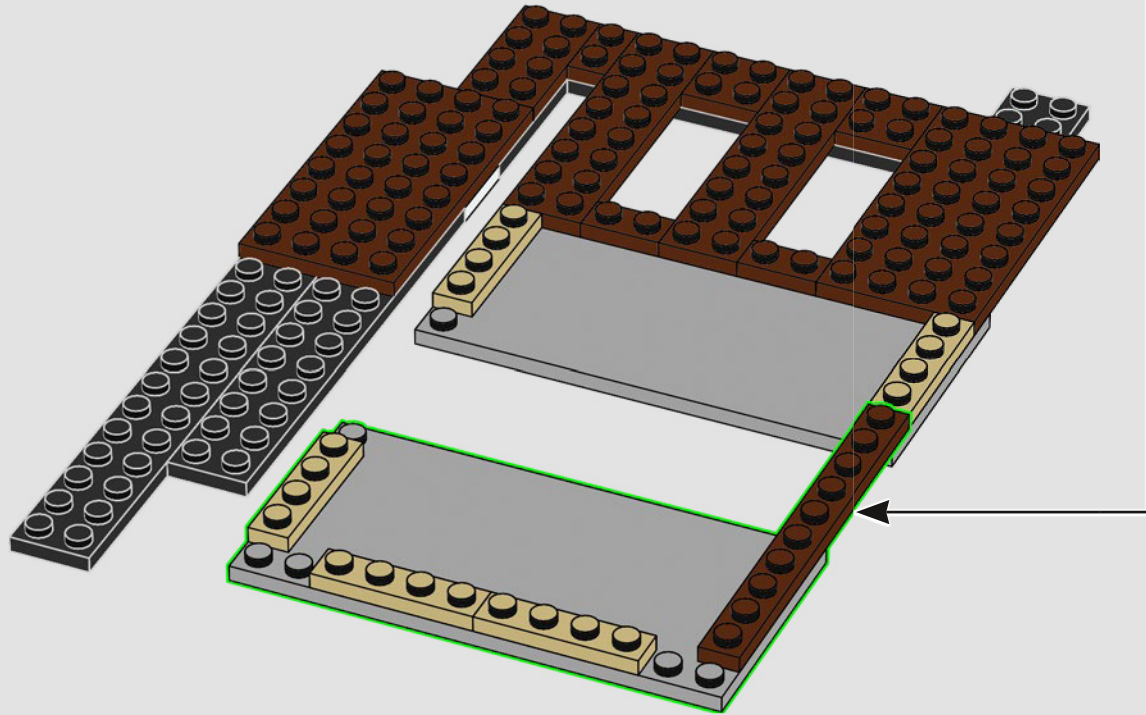

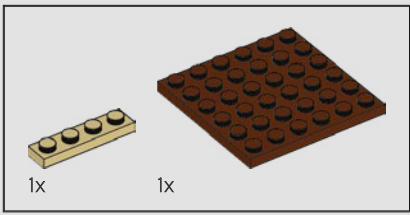

8

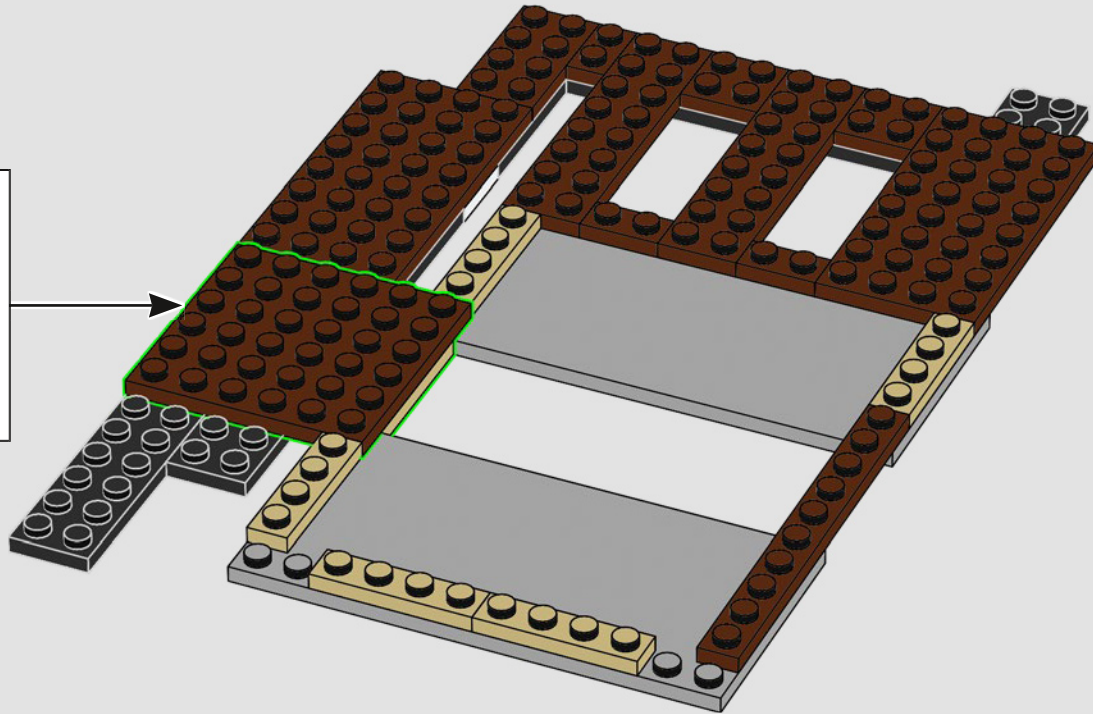

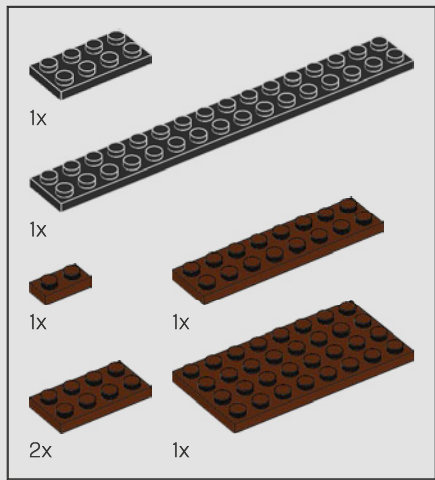

9

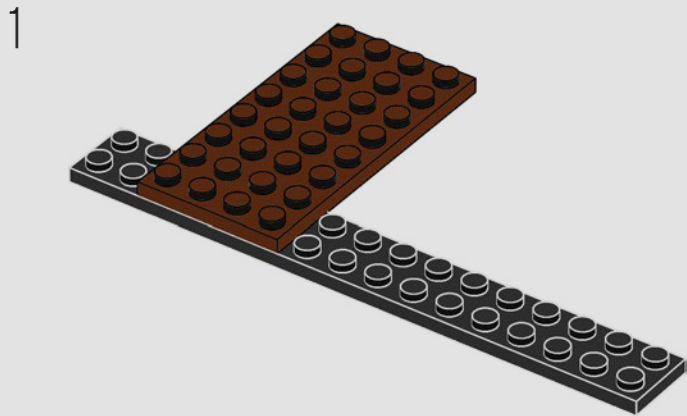

2

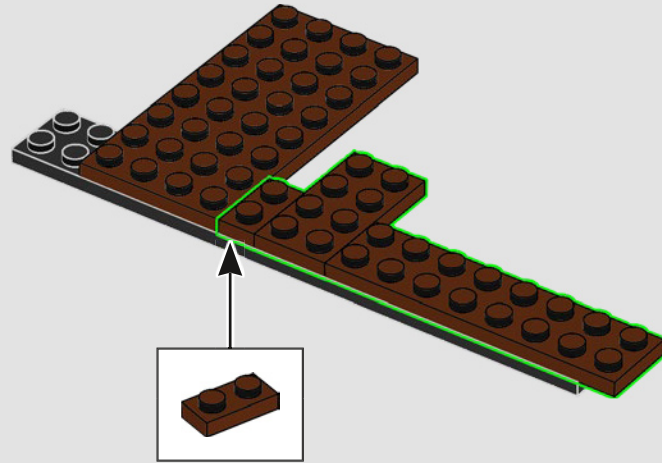

3

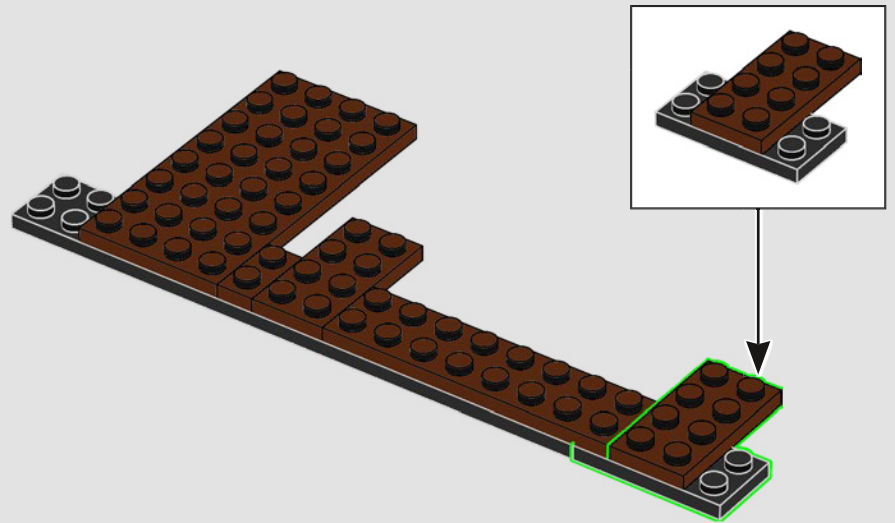

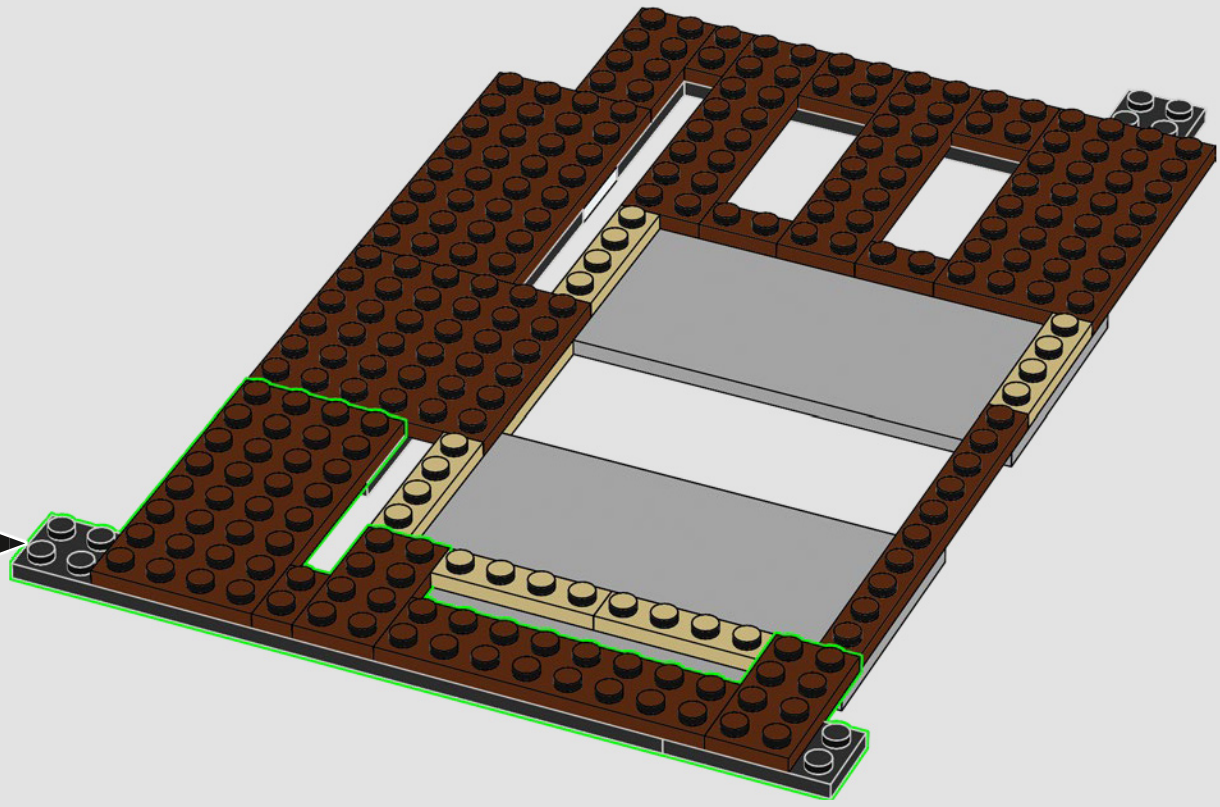

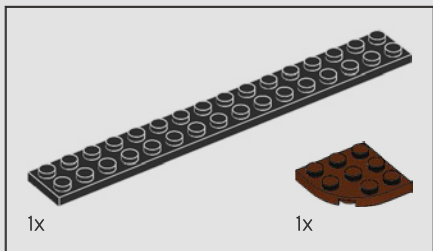

10

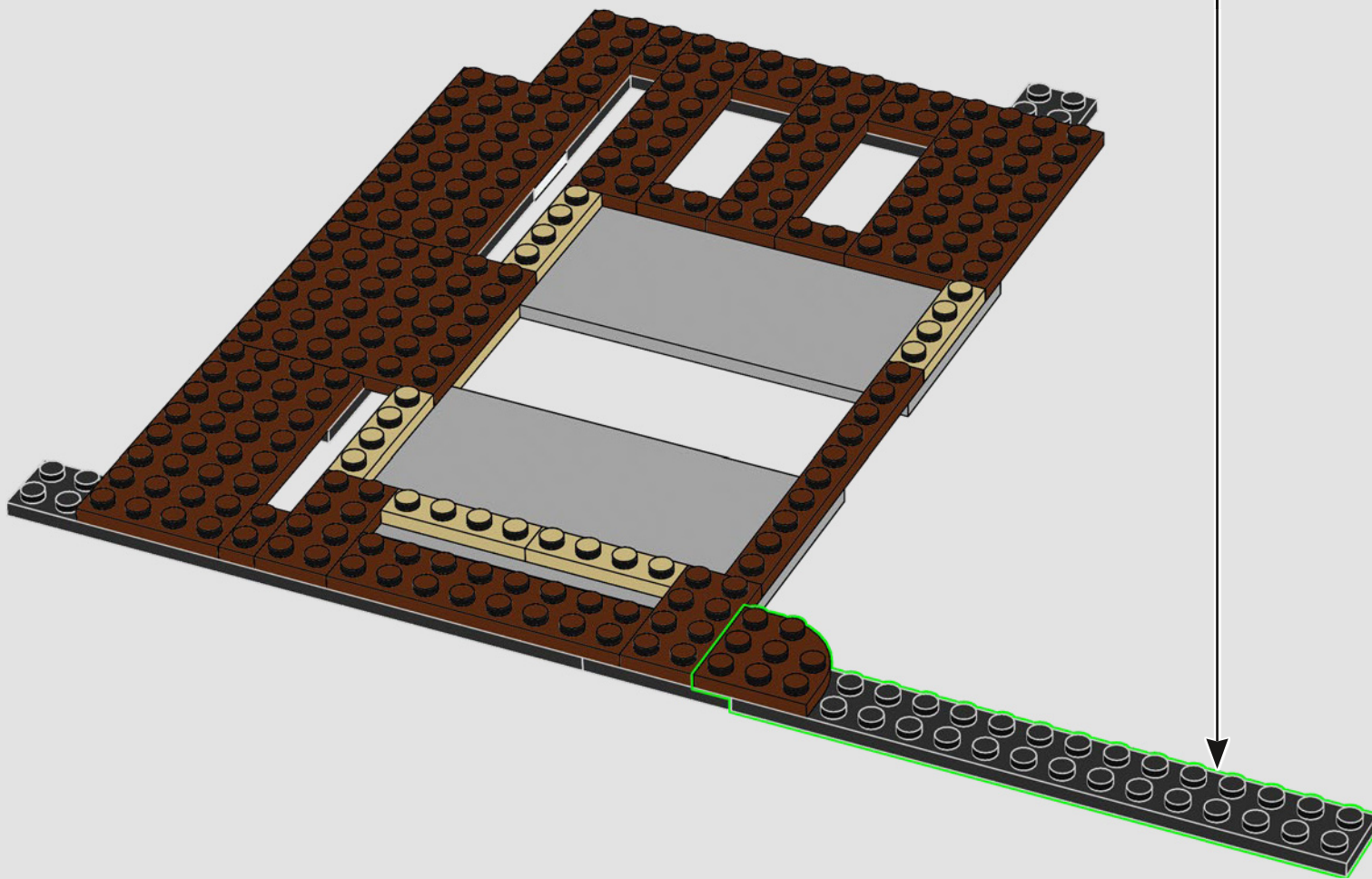
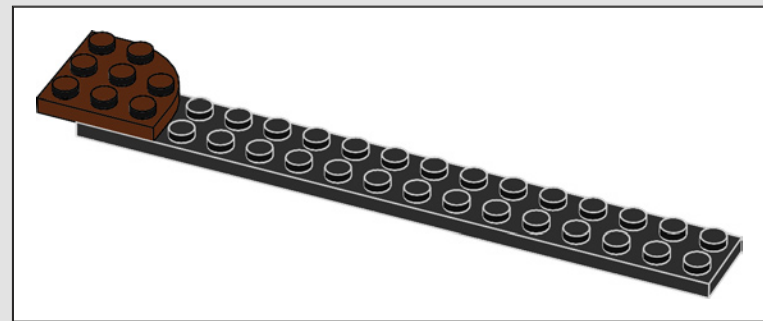

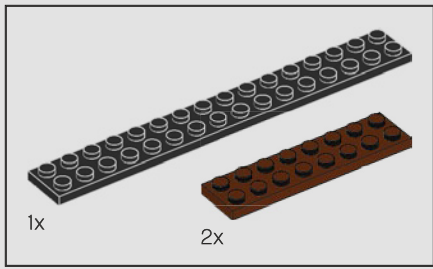

11

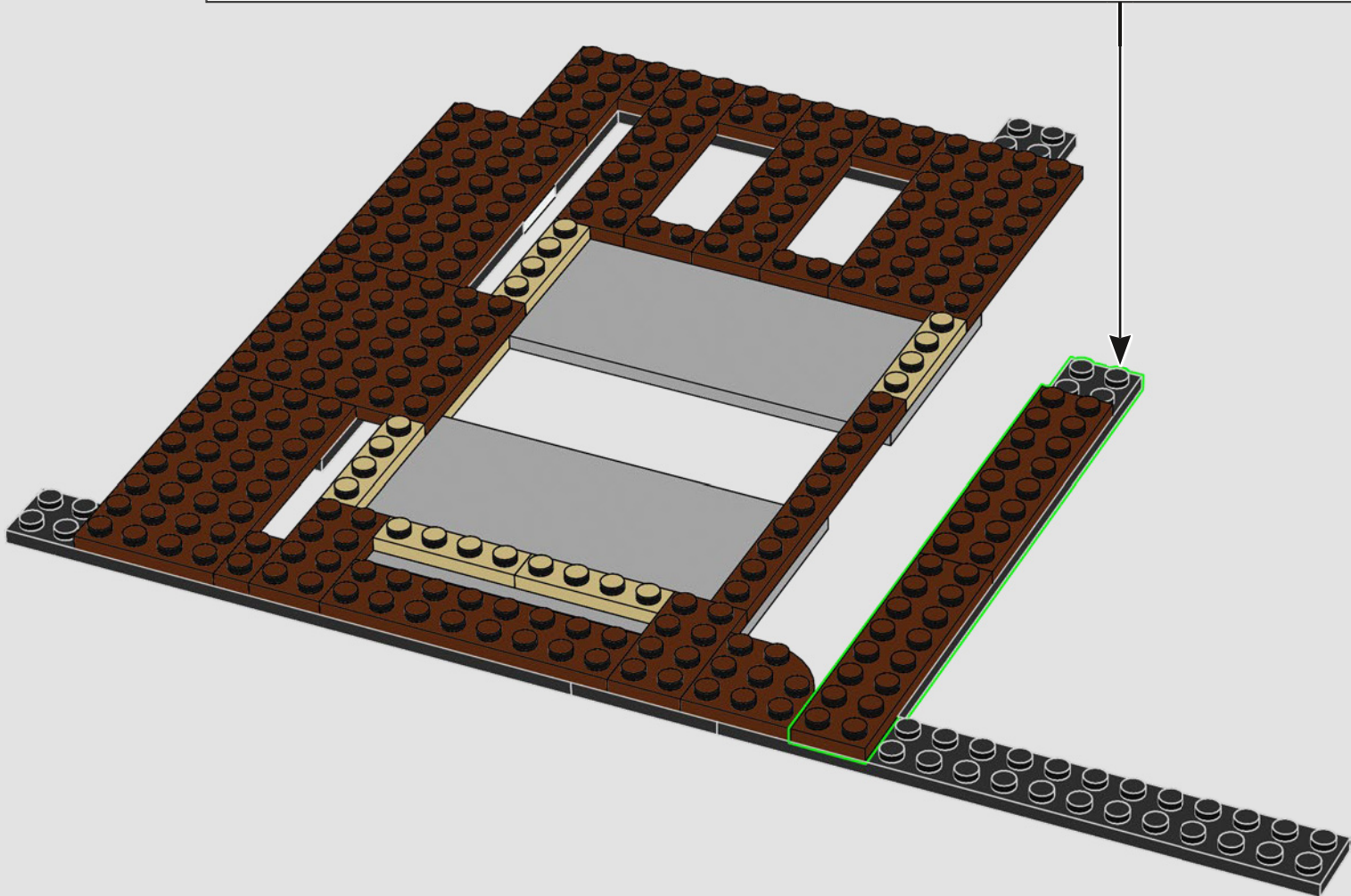
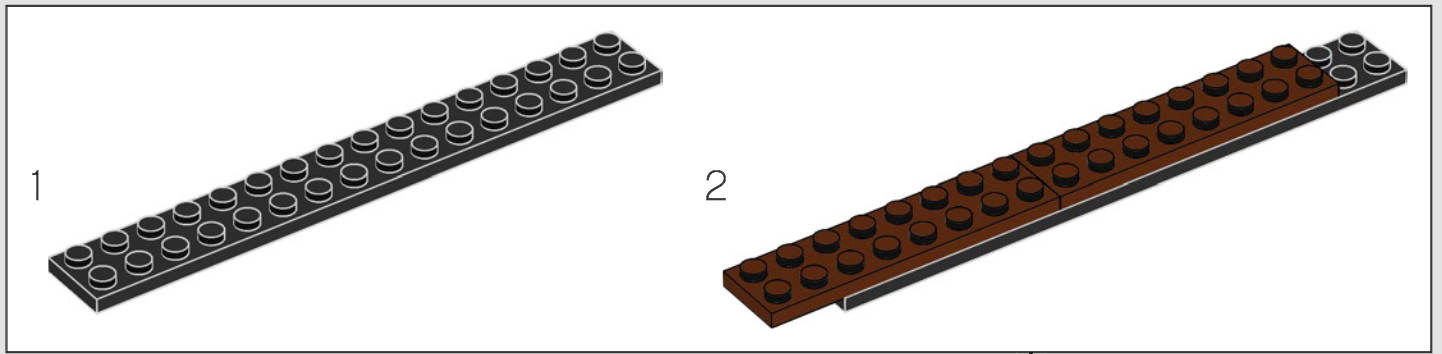

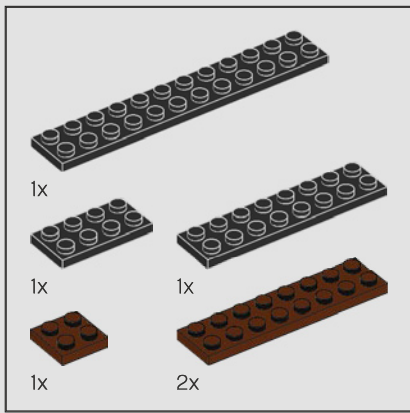

12

1

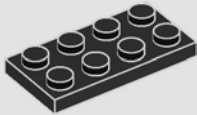

2

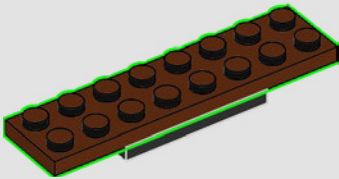

3

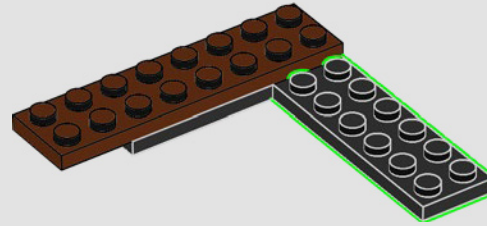

4

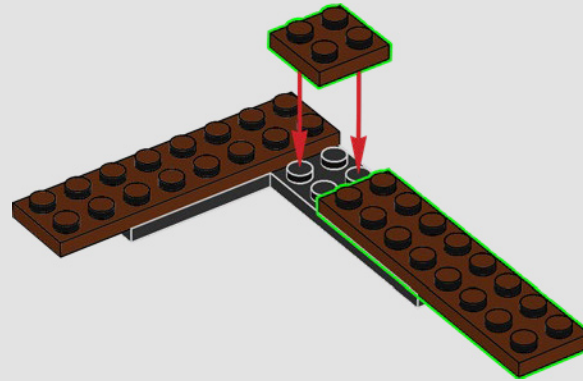

5

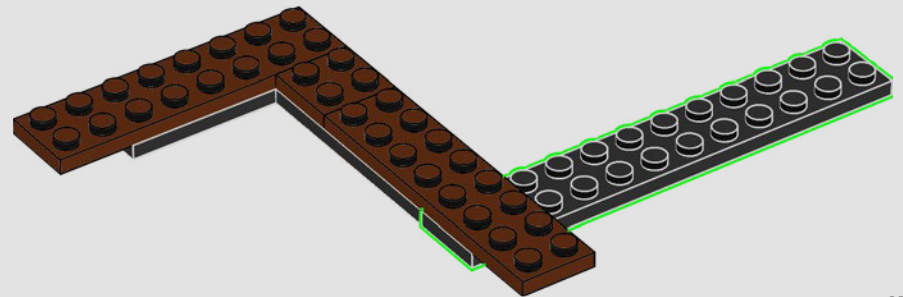

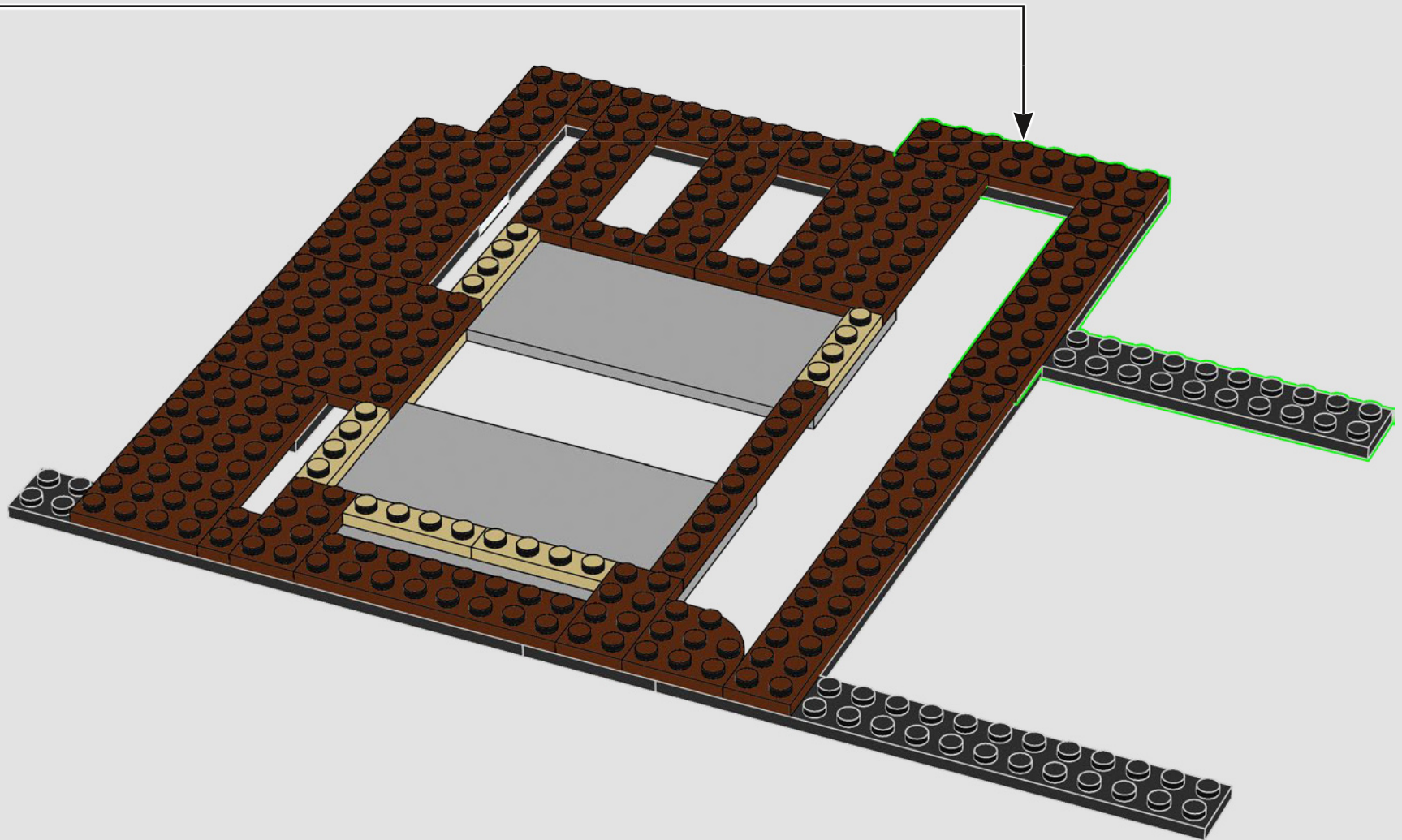

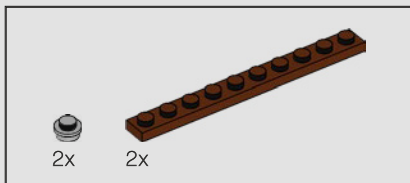

13

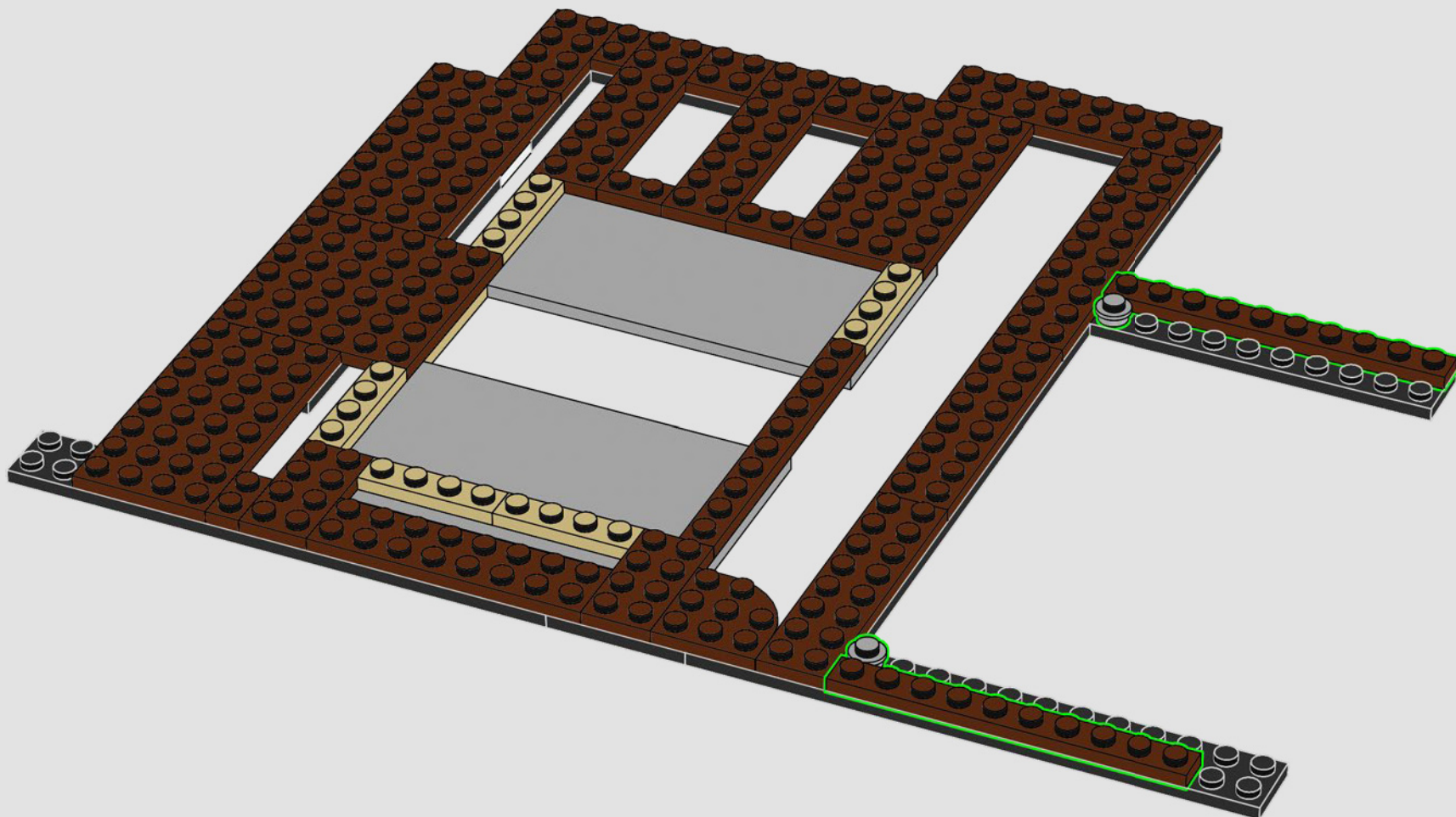

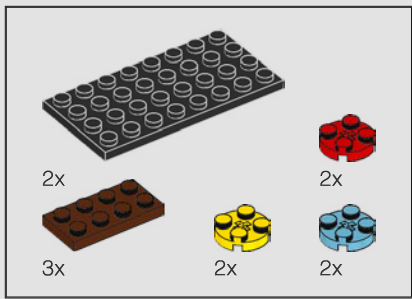

14

1

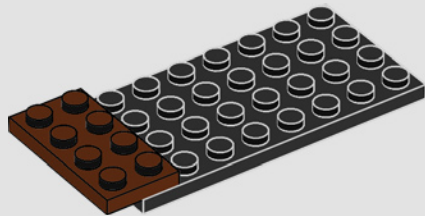

2

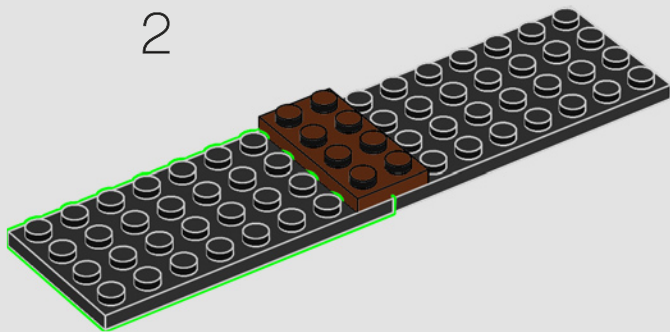

3

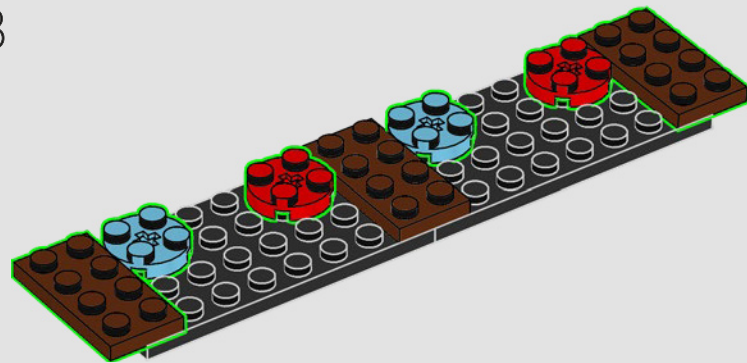

4

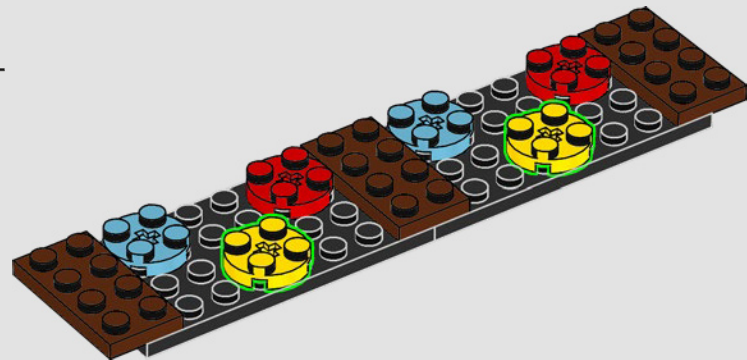

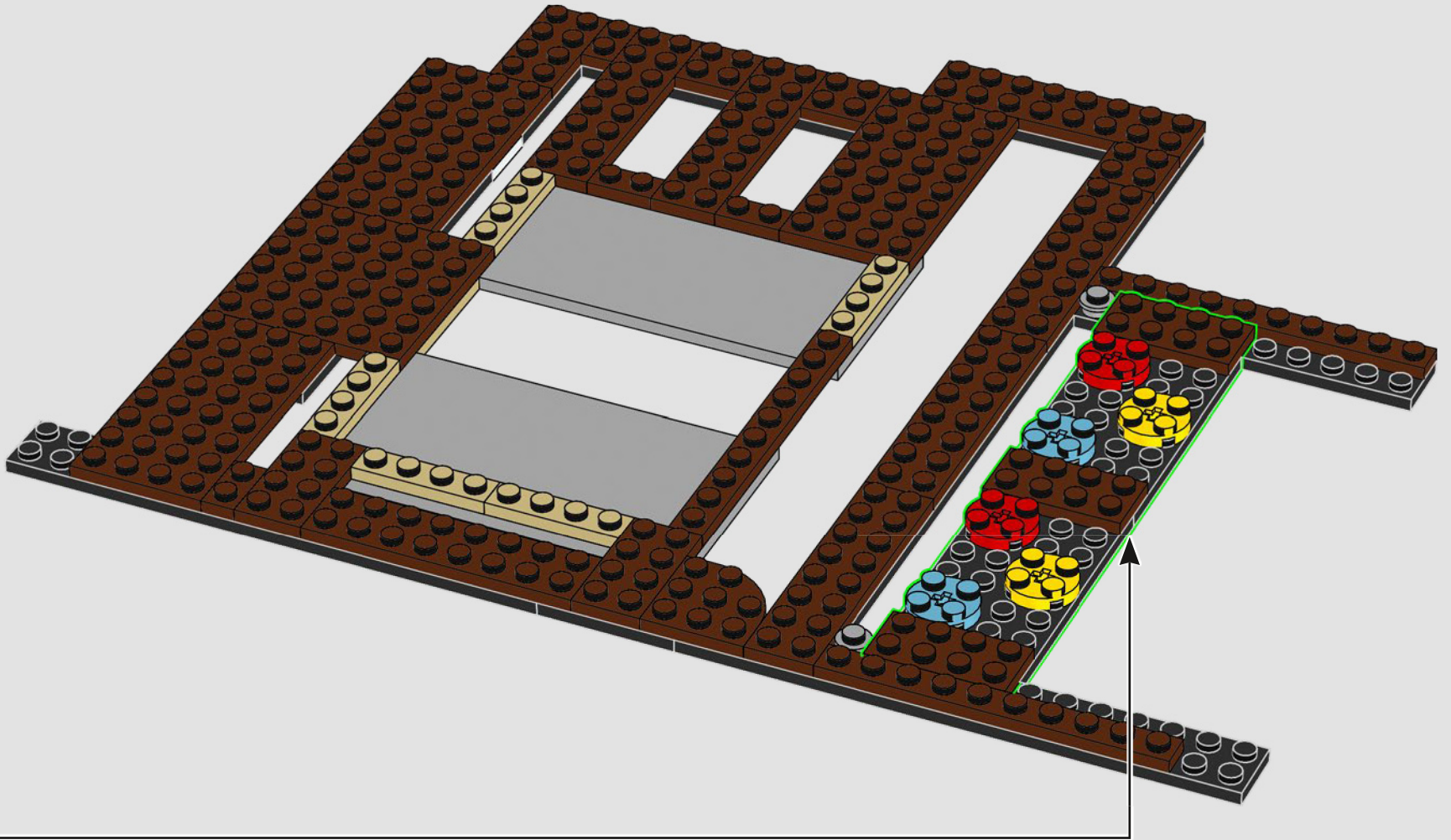

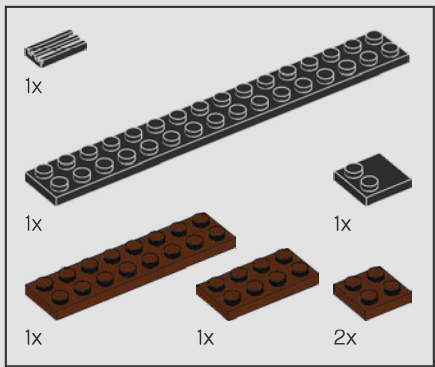

15

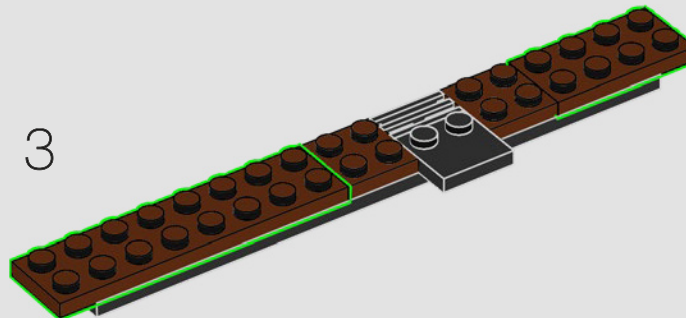
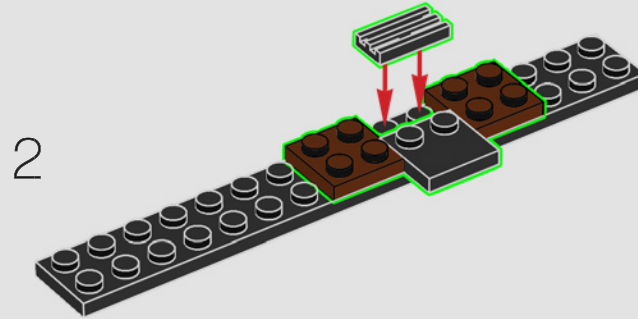
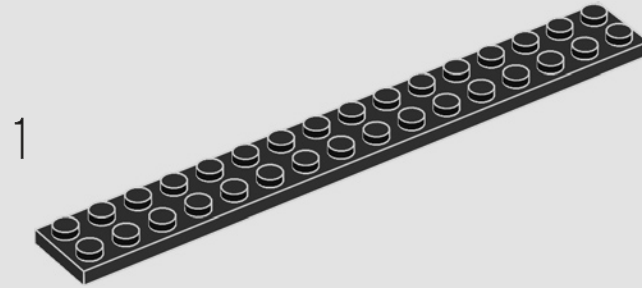

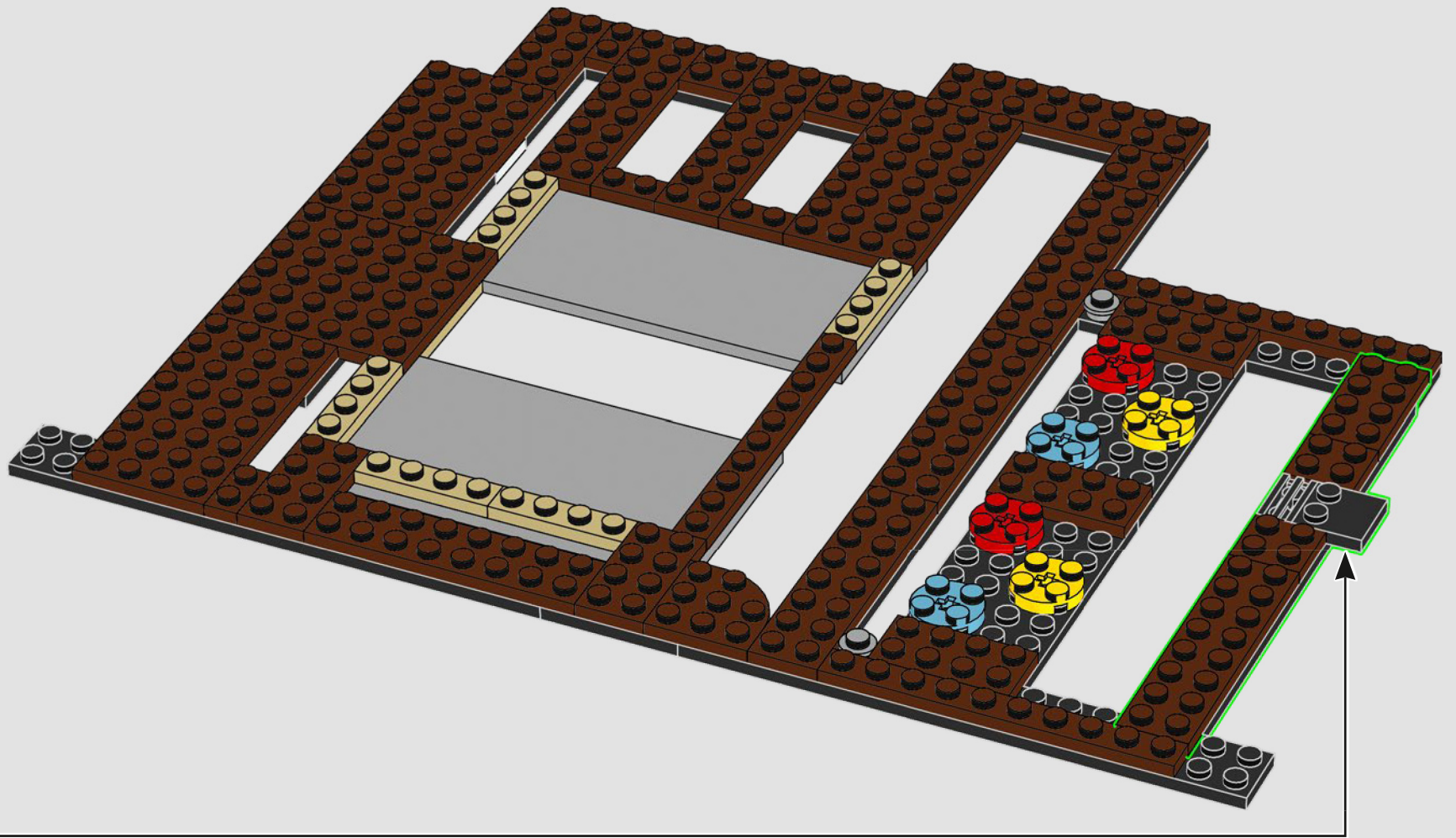

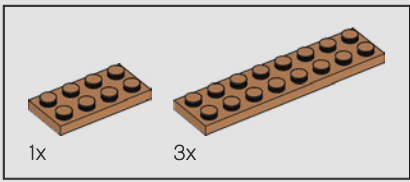

16

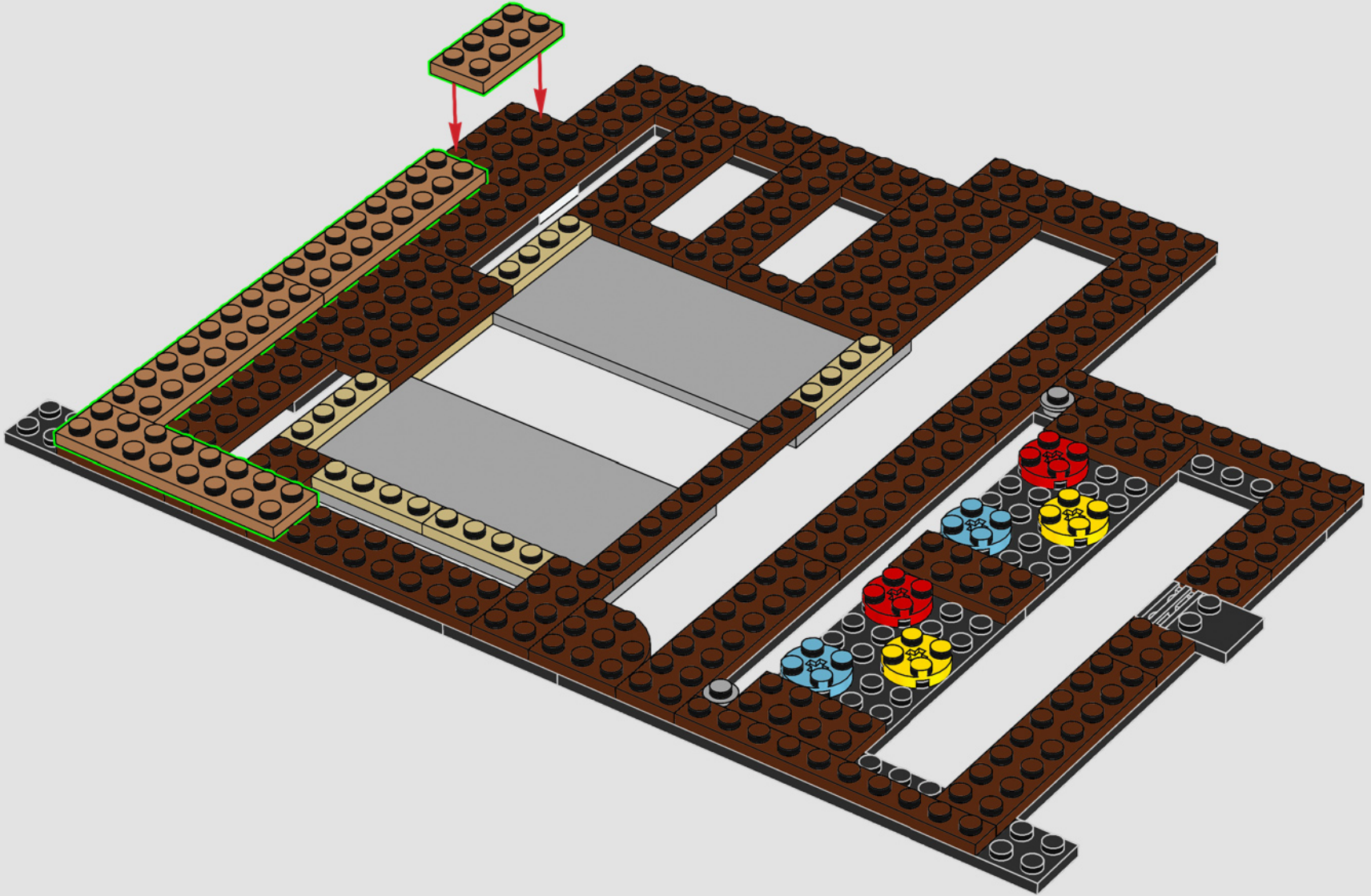

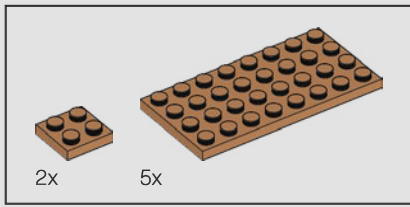

17

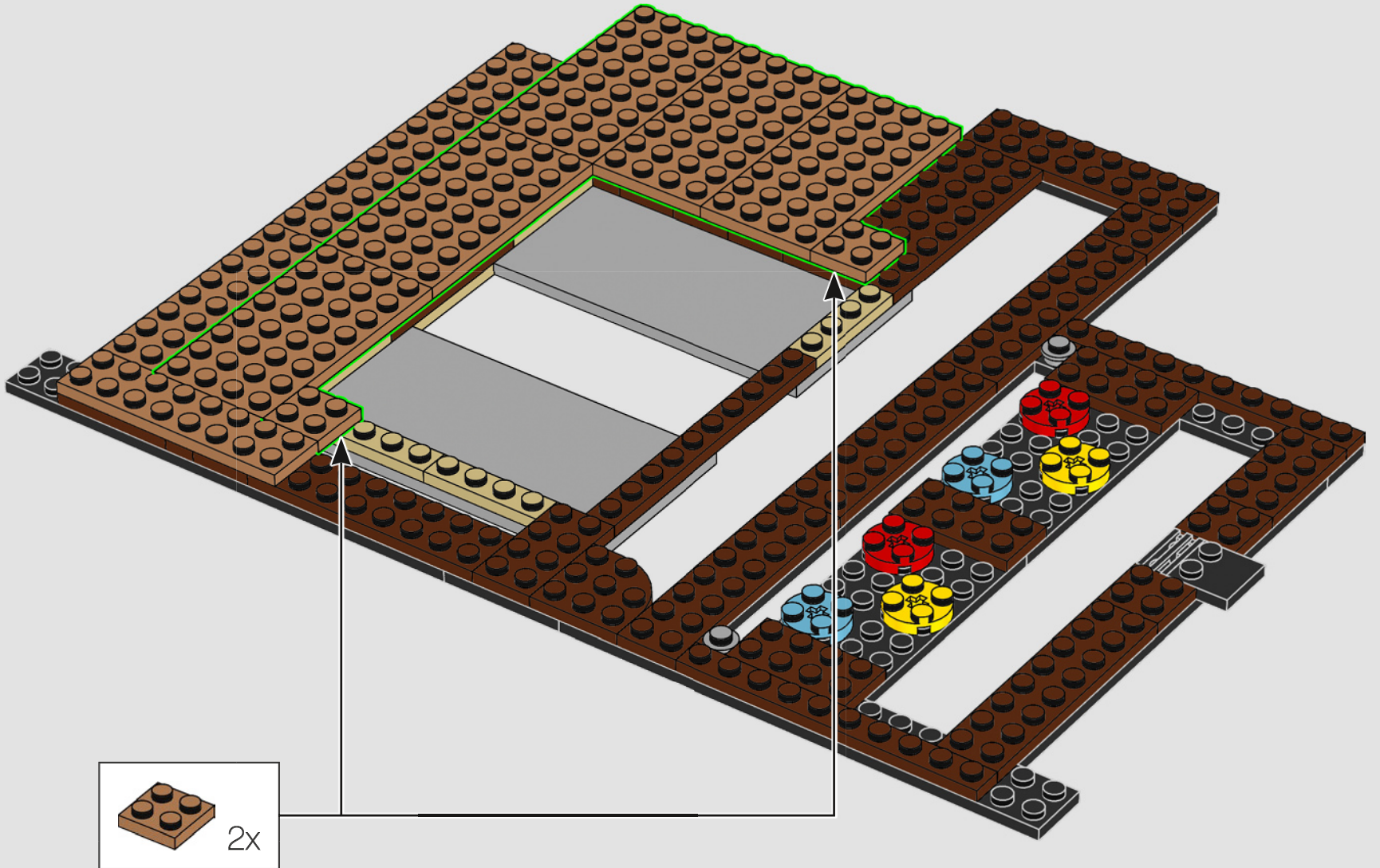

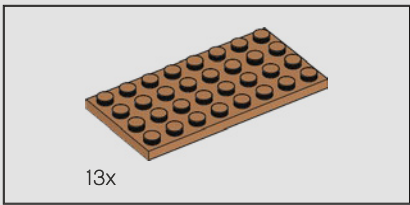

18

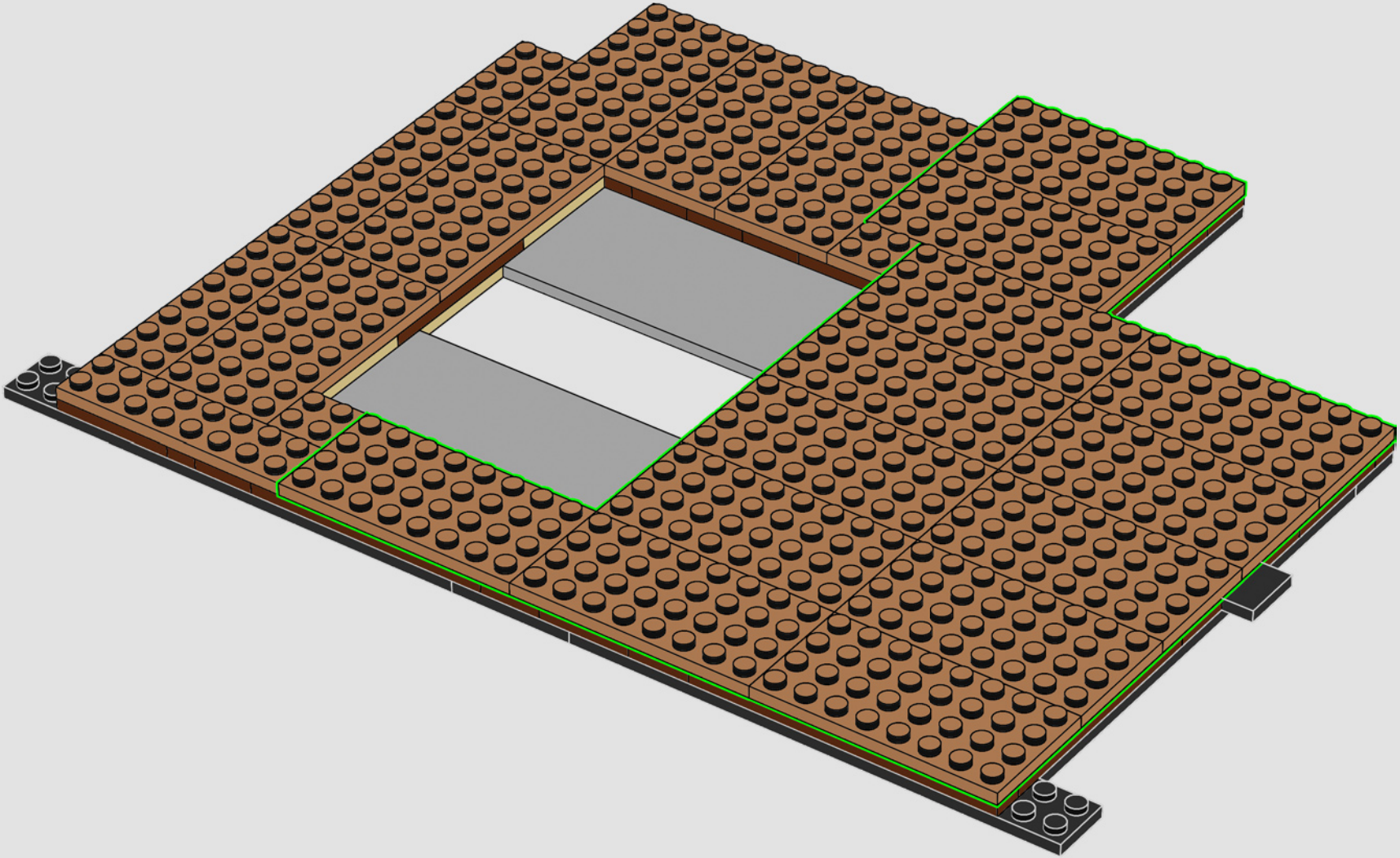

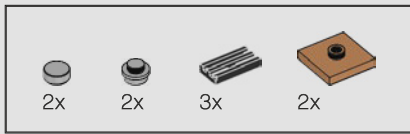

19

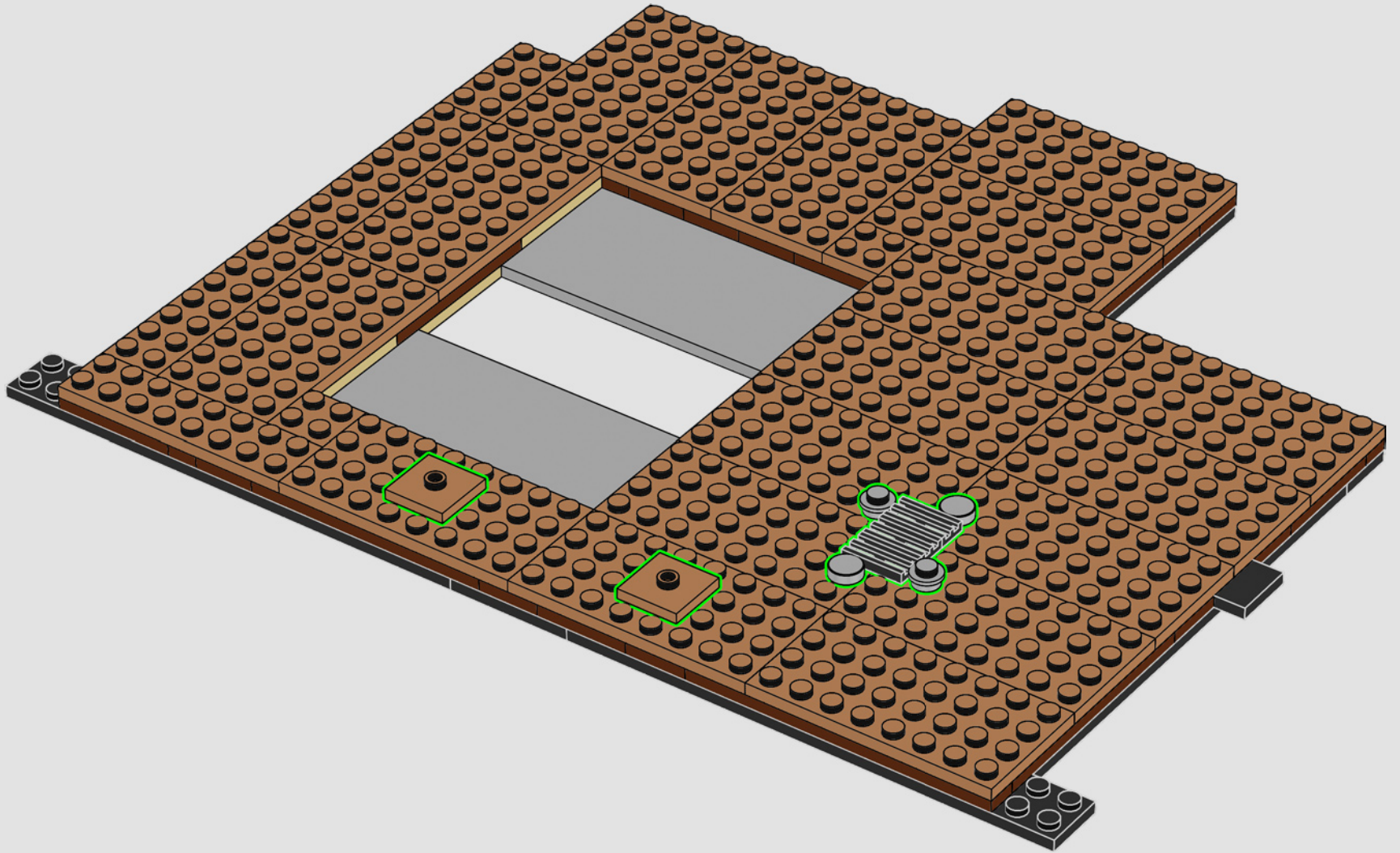

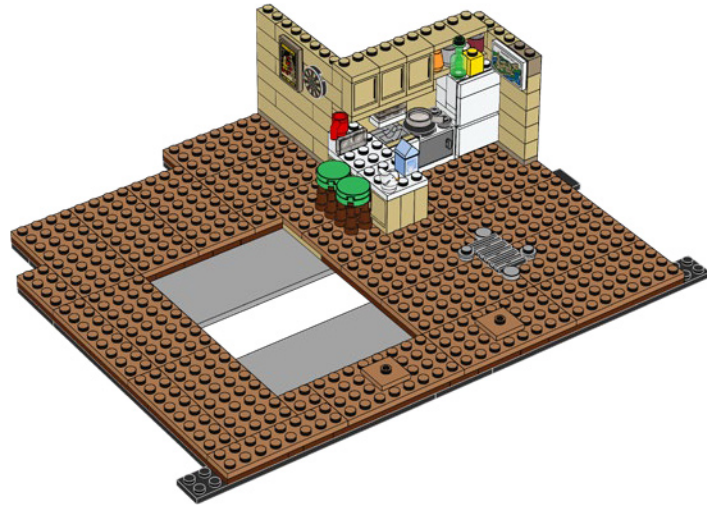

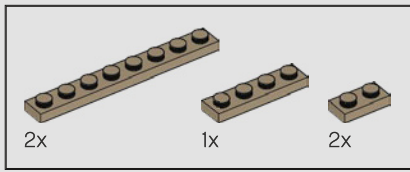

20

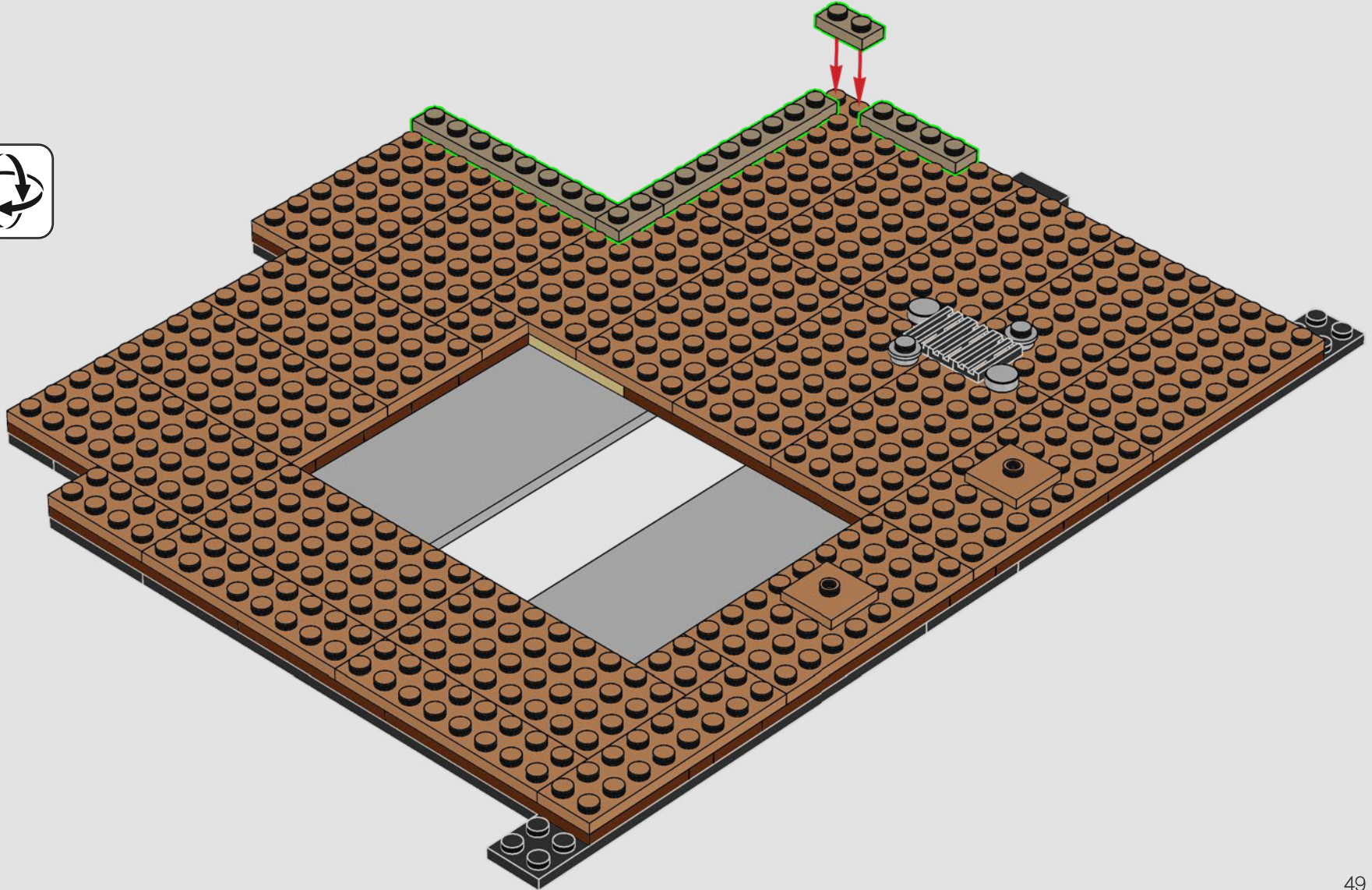

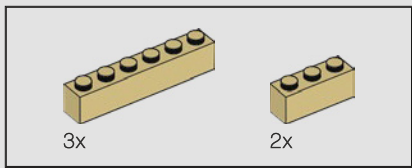

21

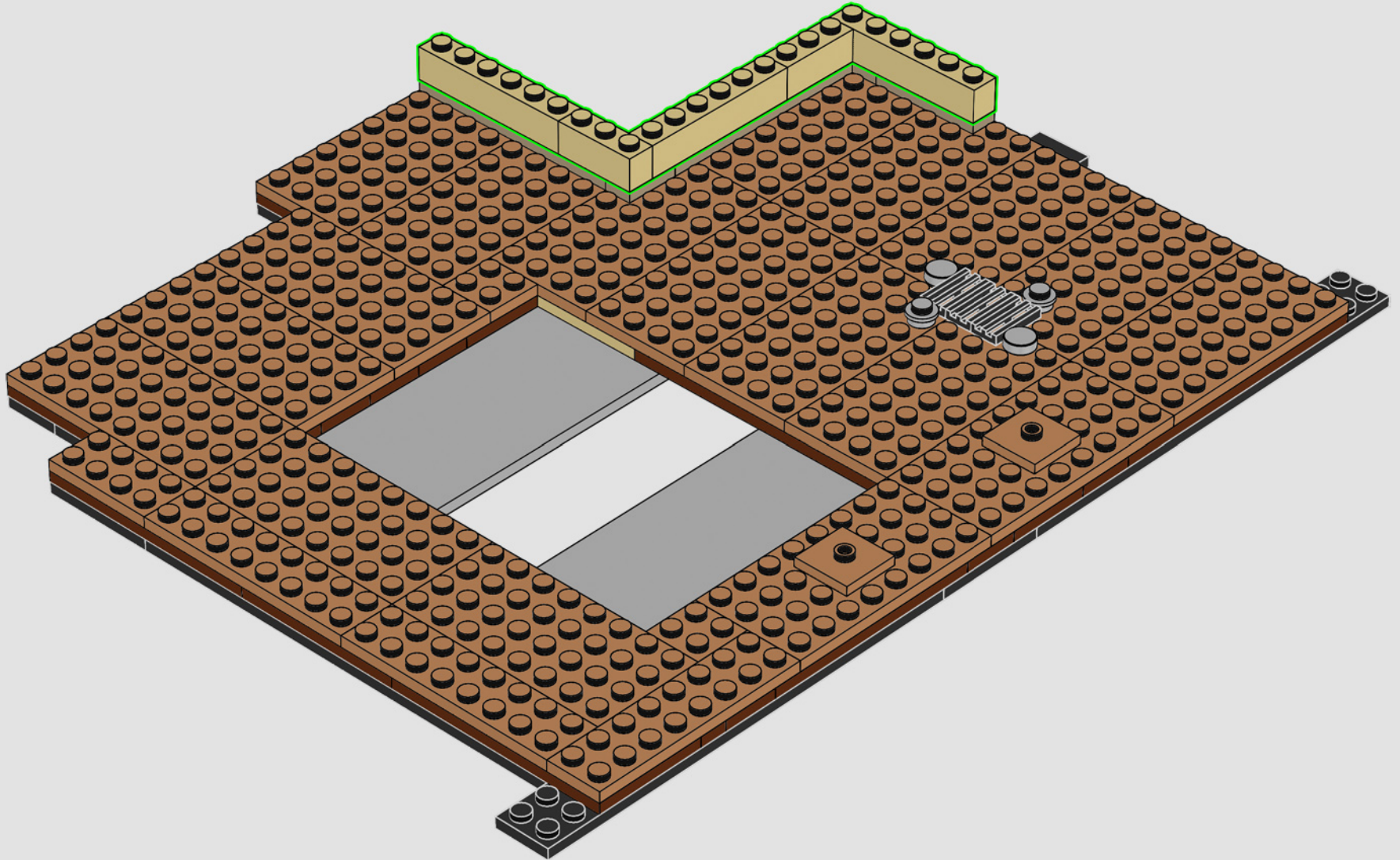

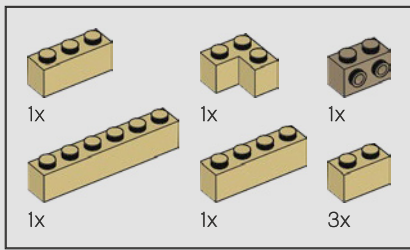

22

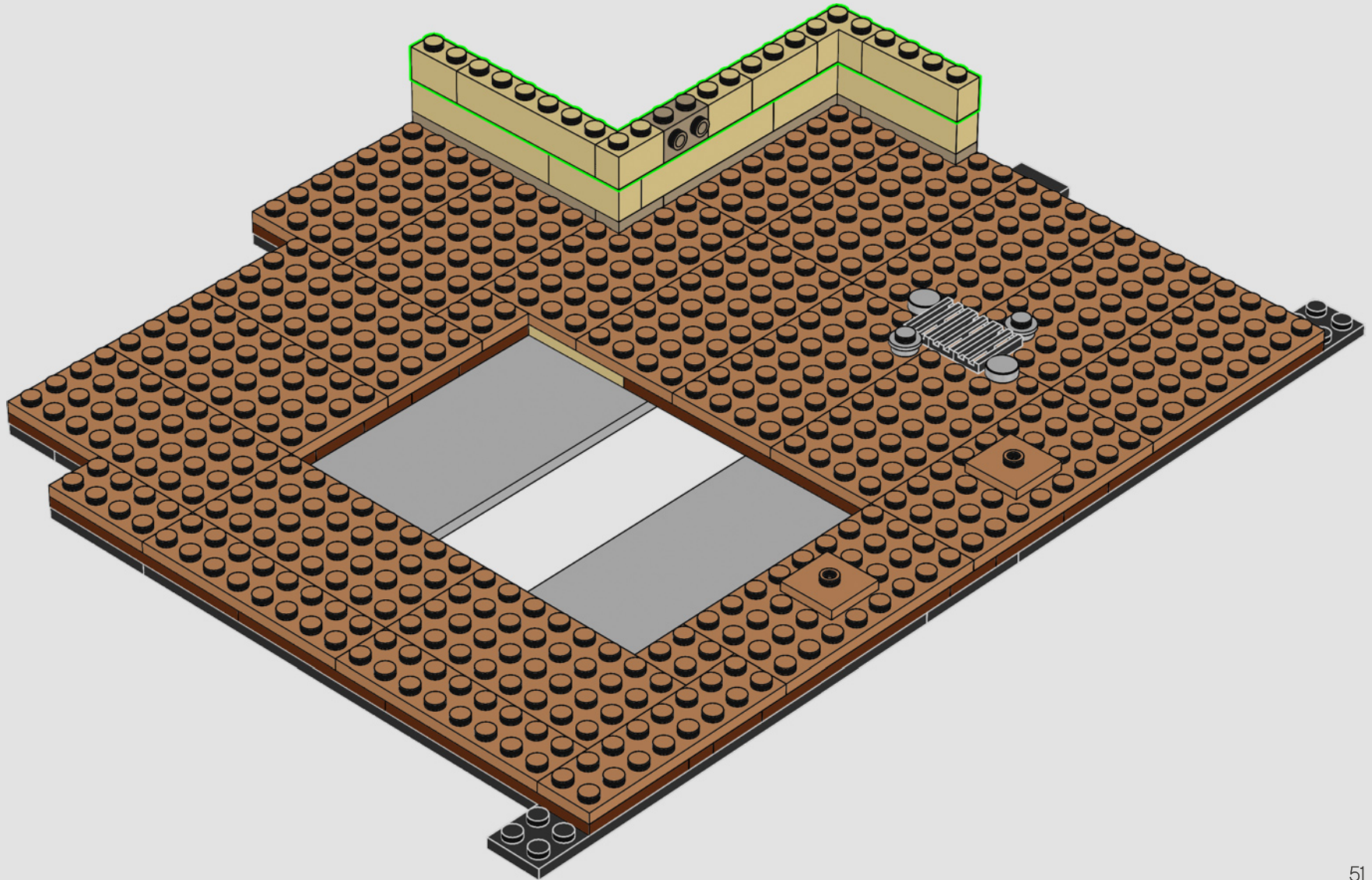

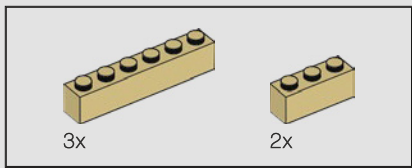

23

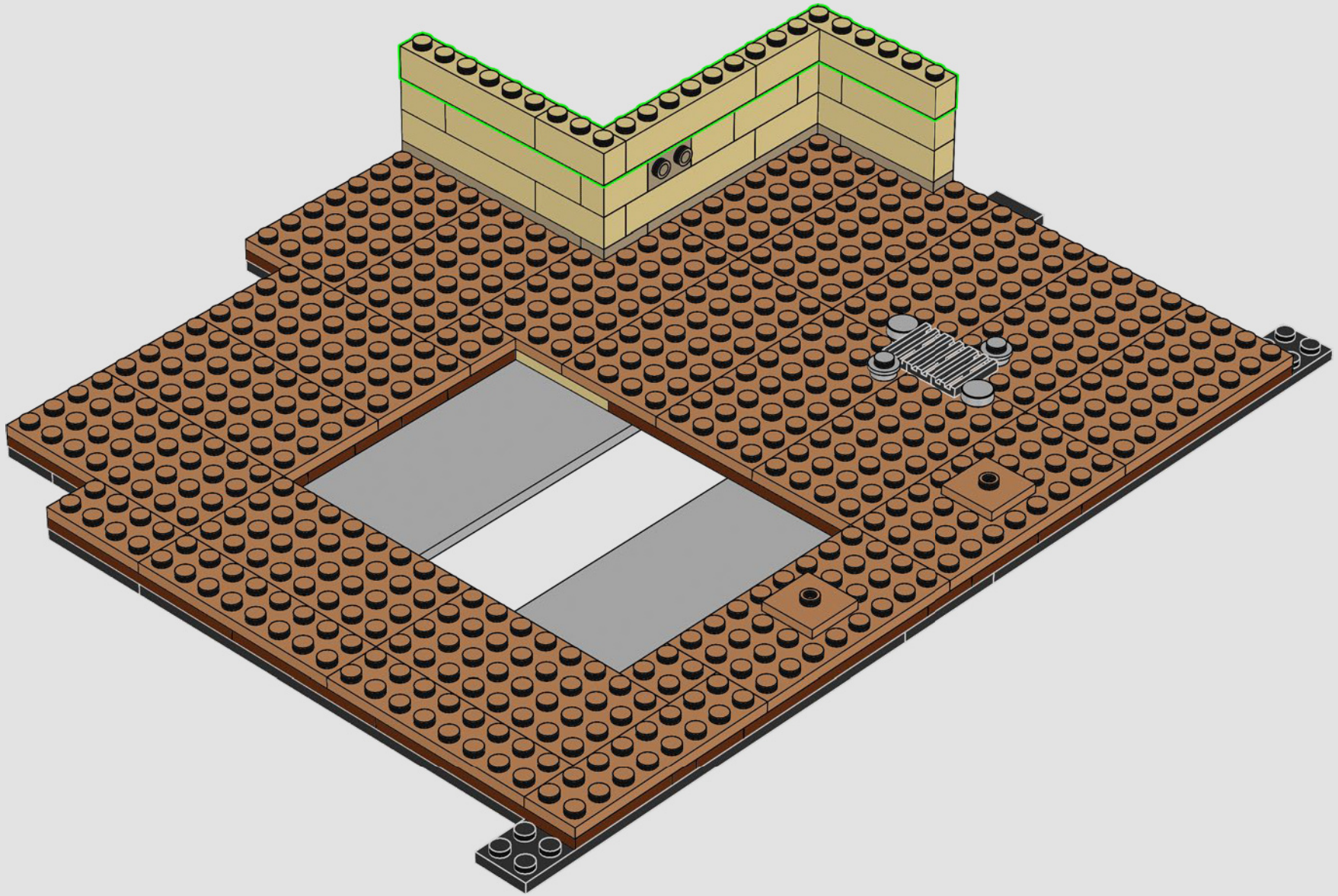

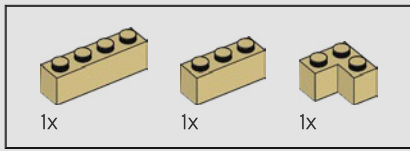

24

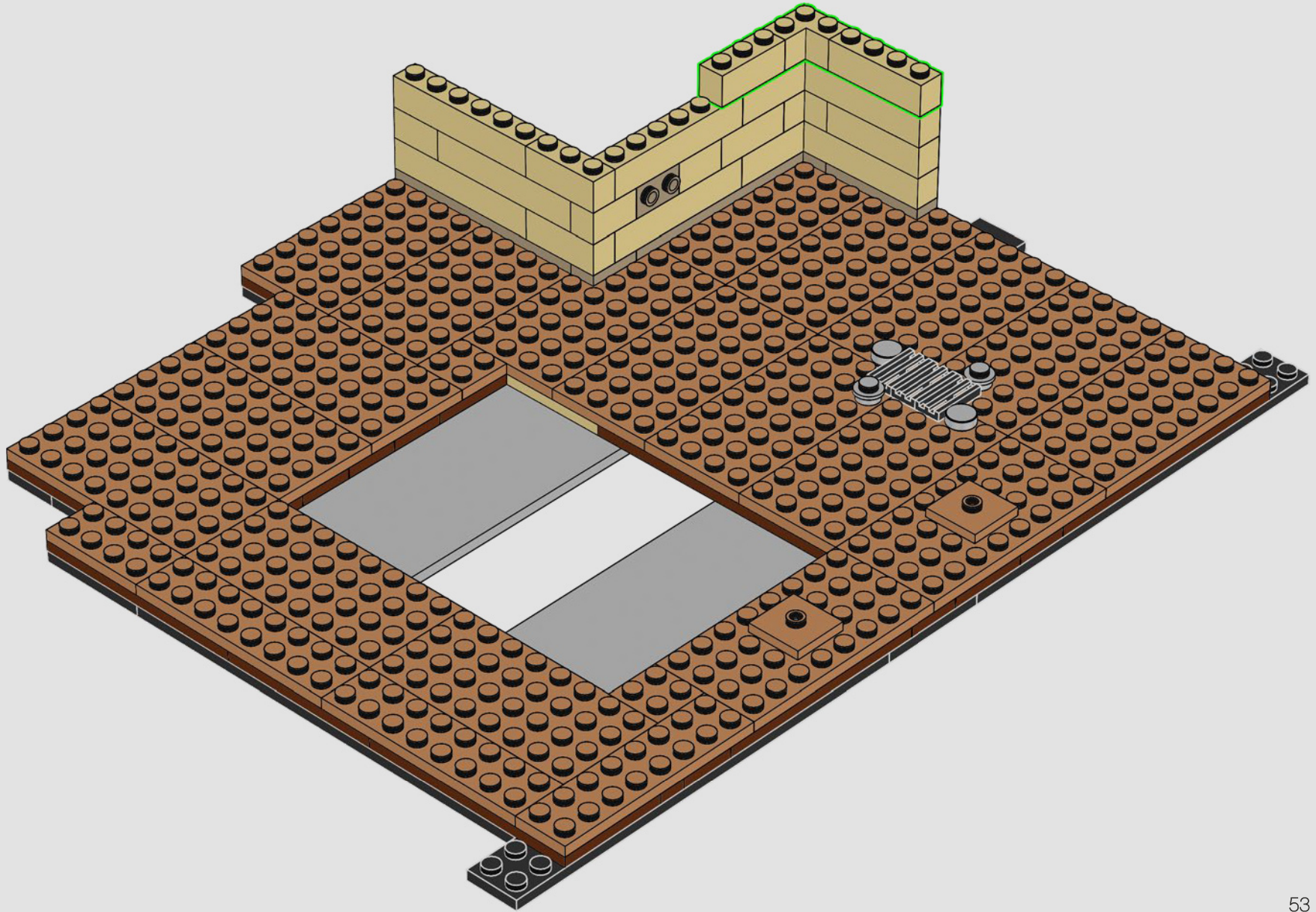

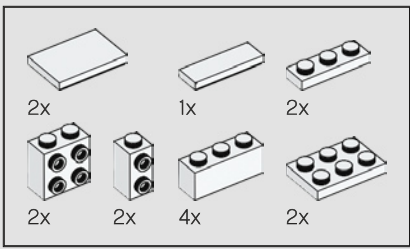

25

1

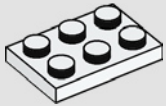

2

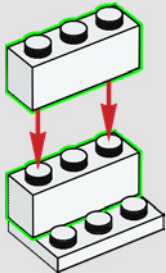

3

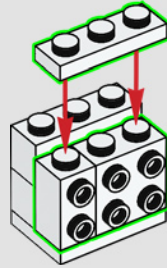

4

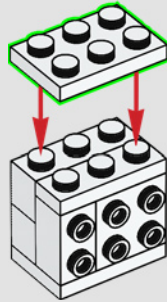

5

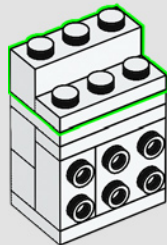

6

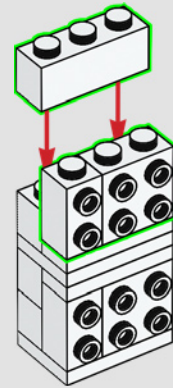

7

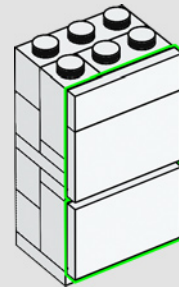

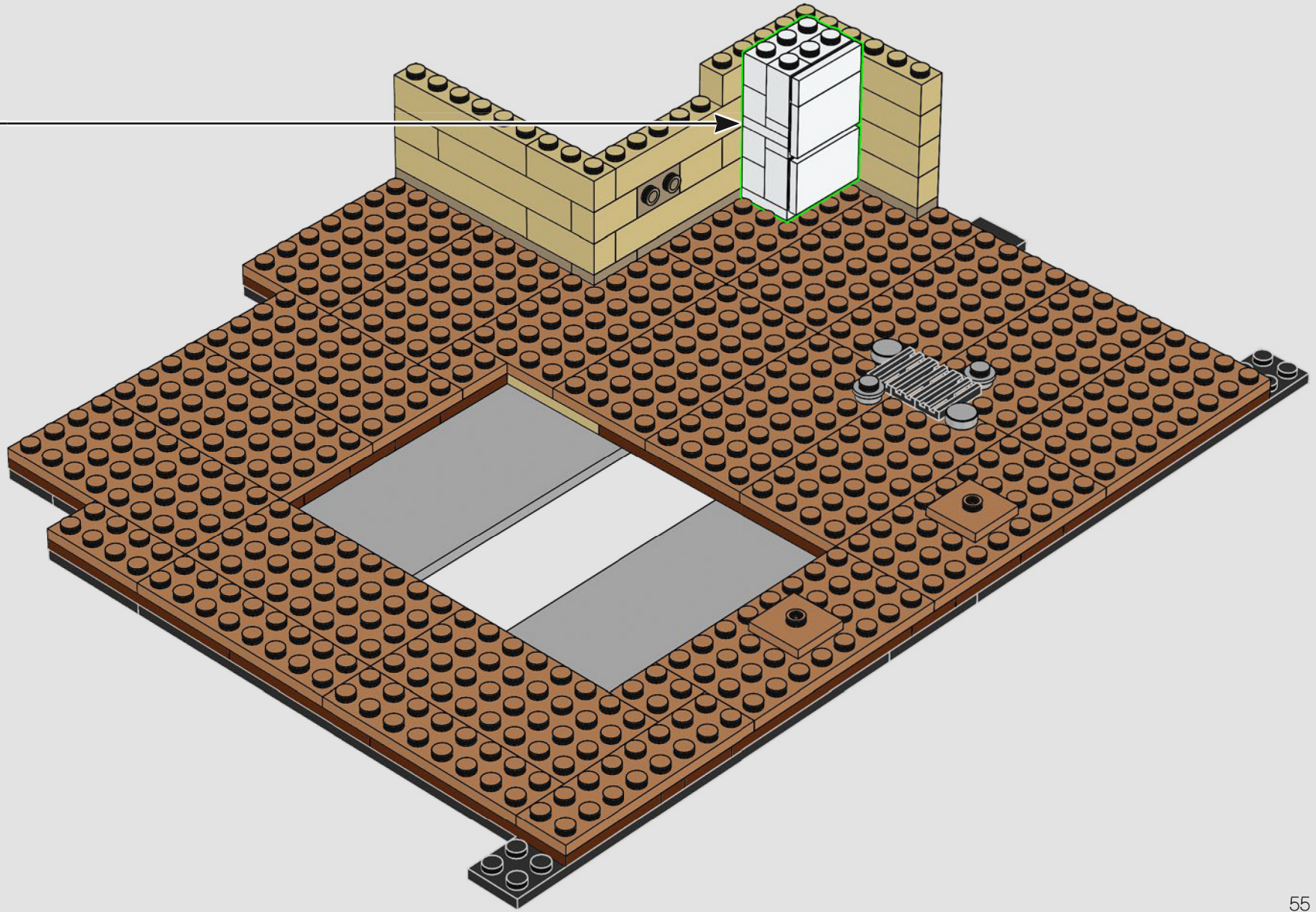

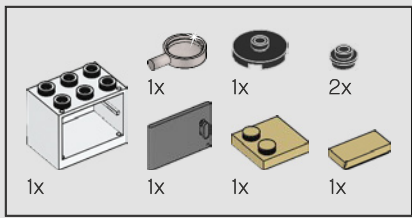

26

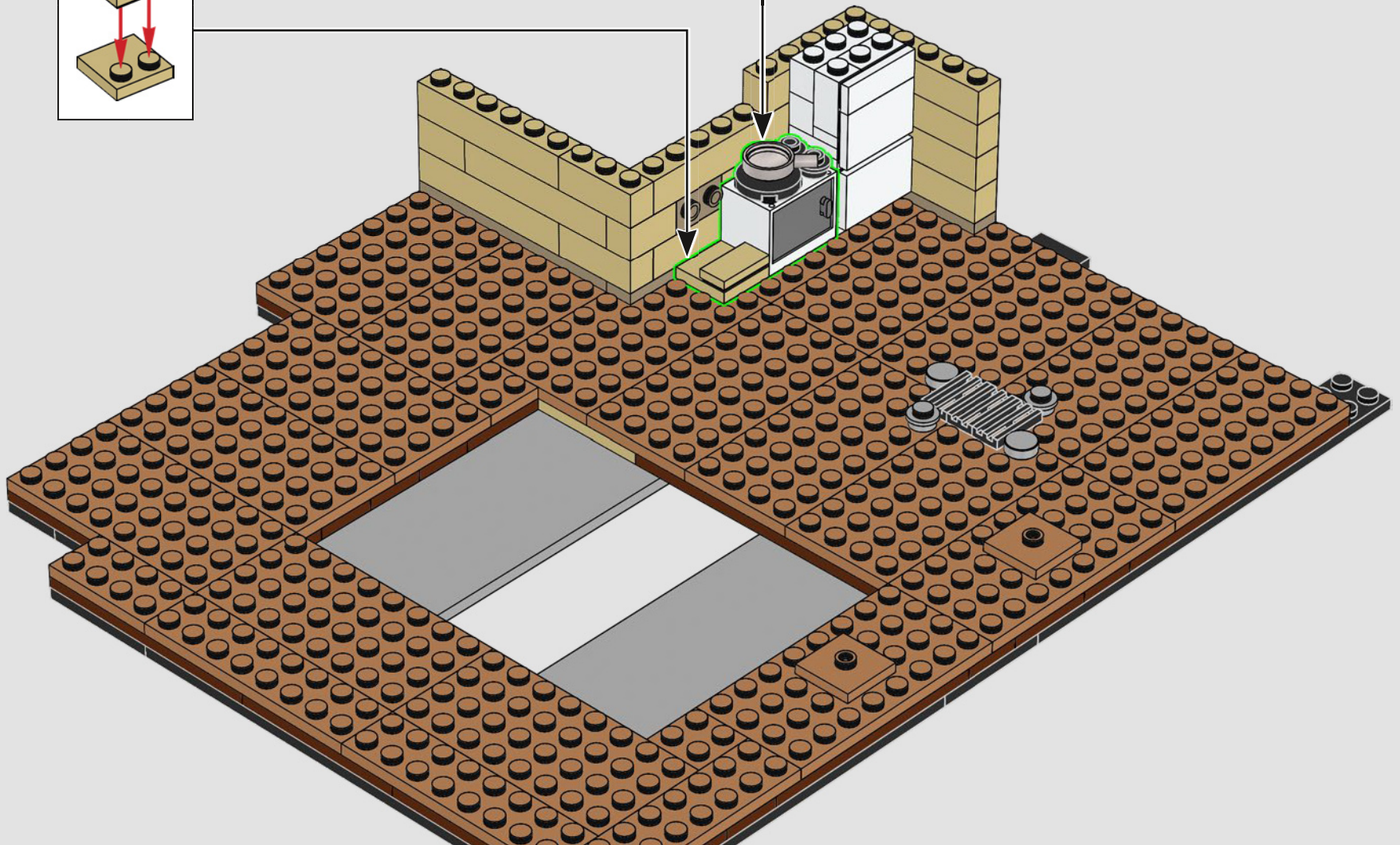
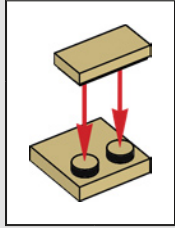
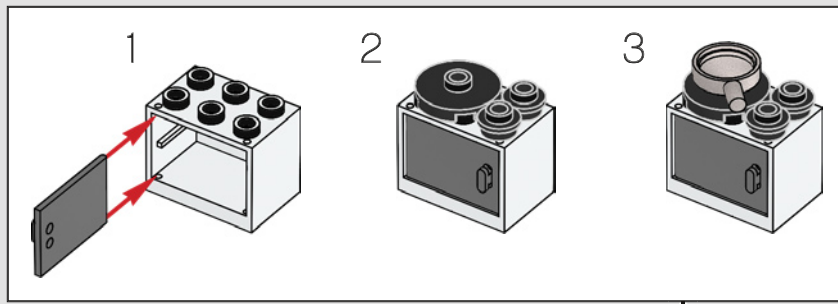

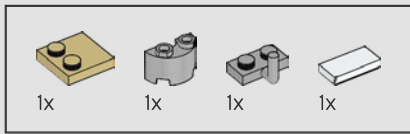

27

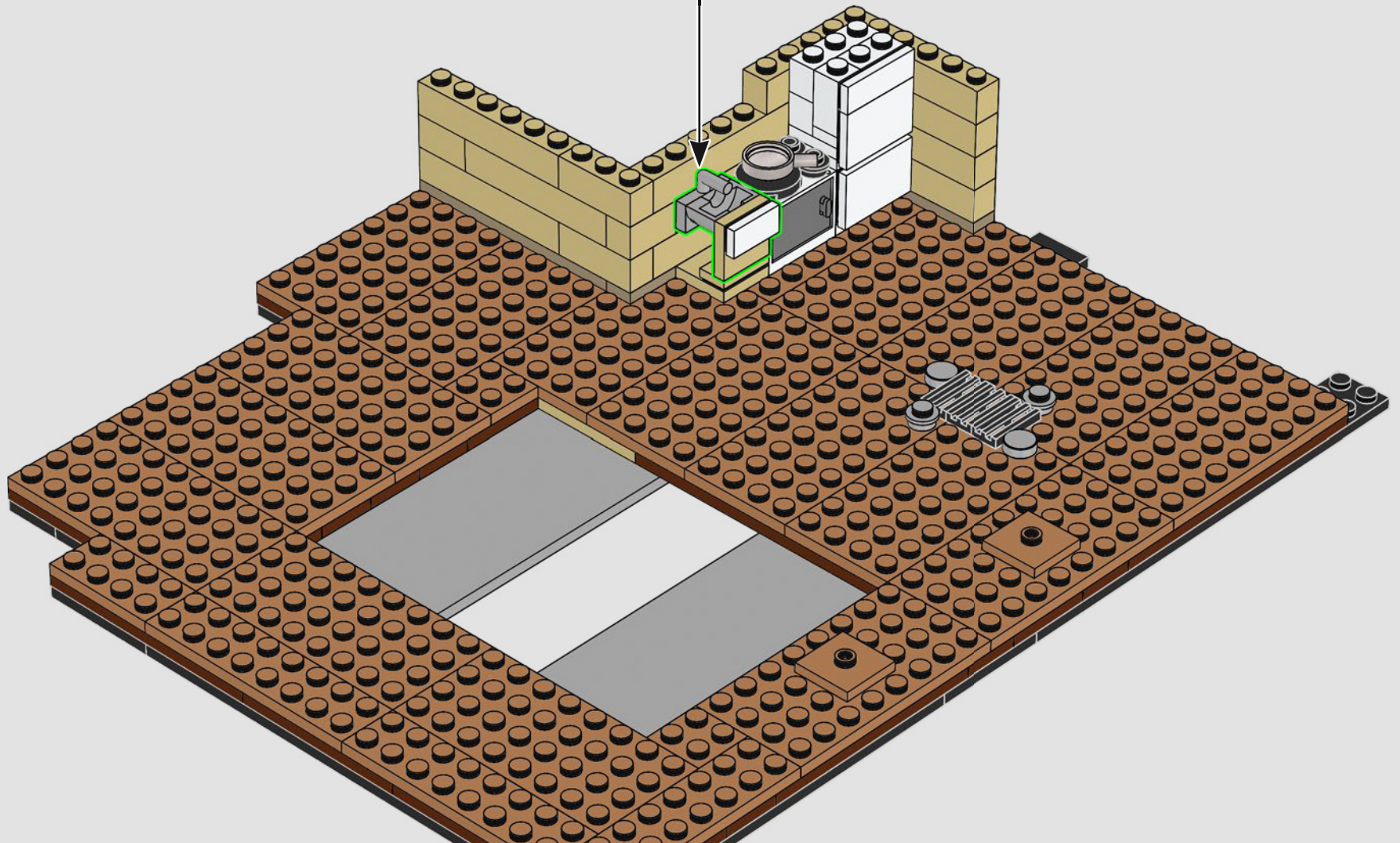
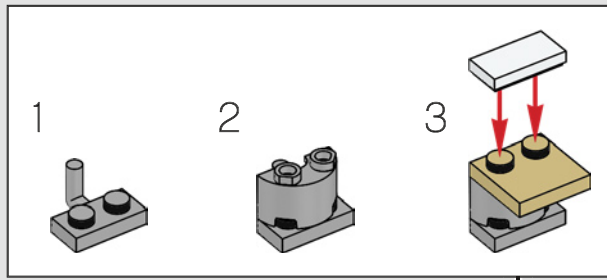

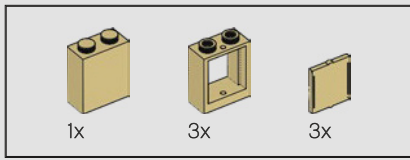

29

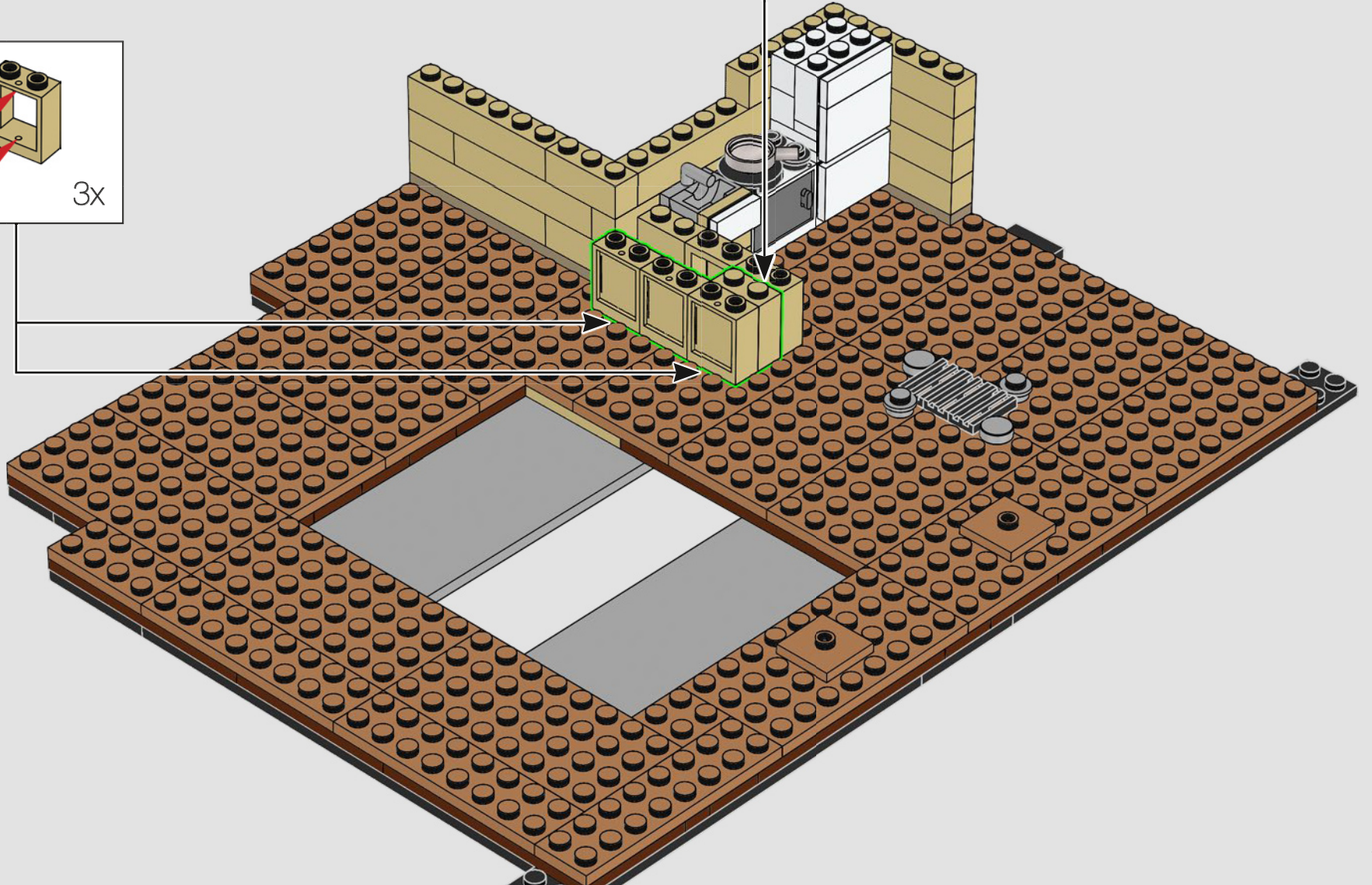
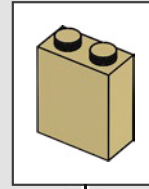
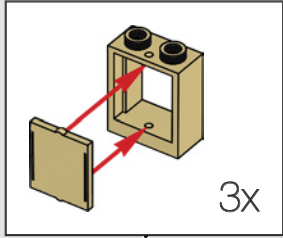

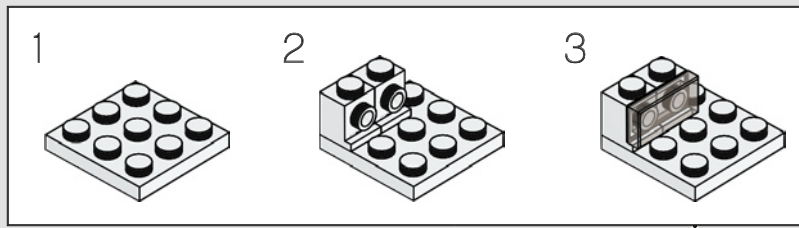
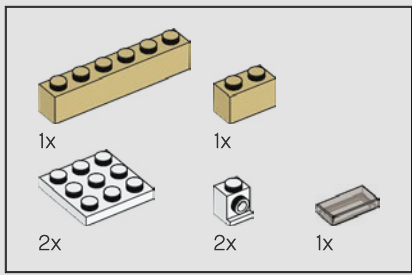

30

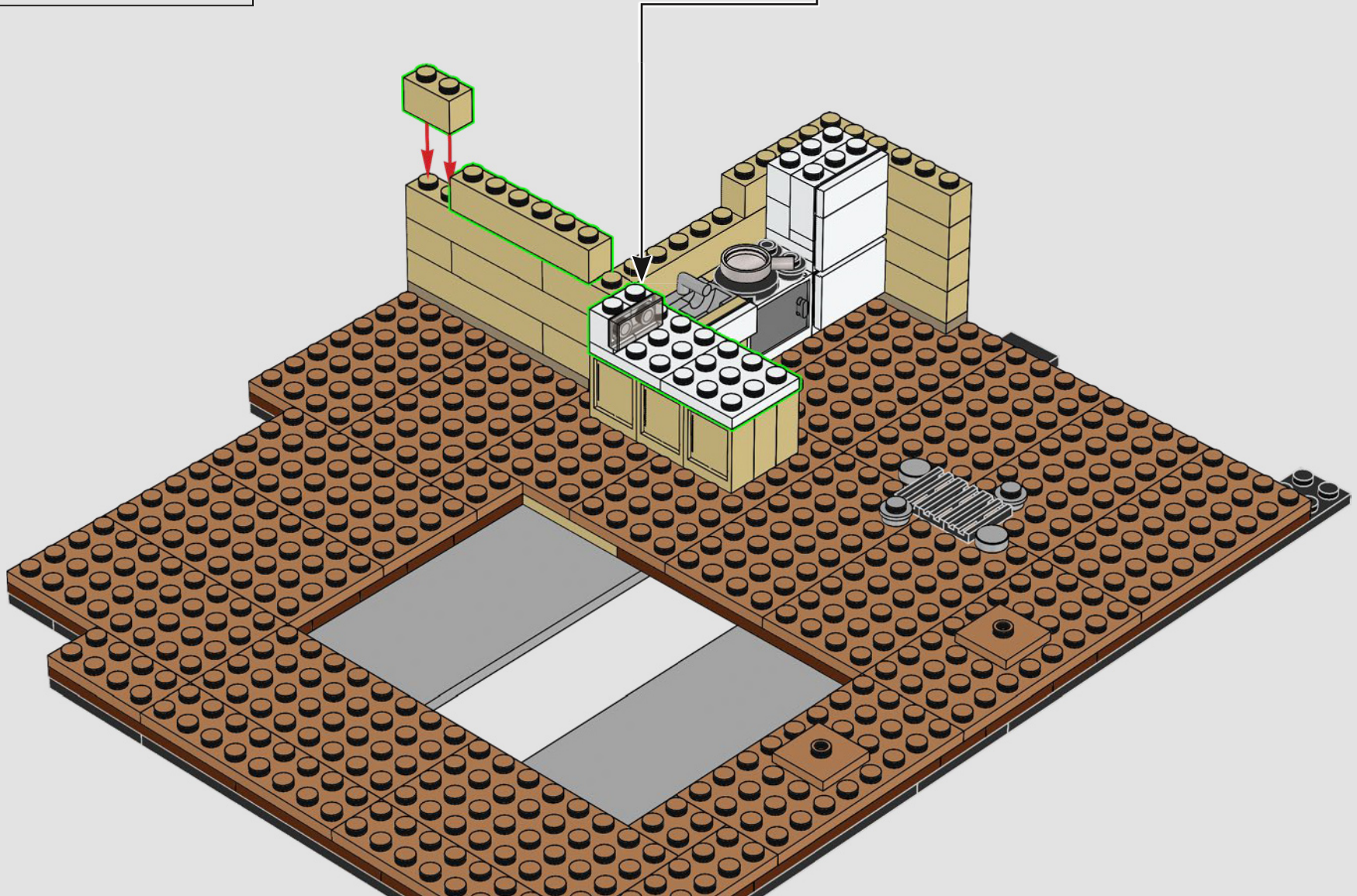

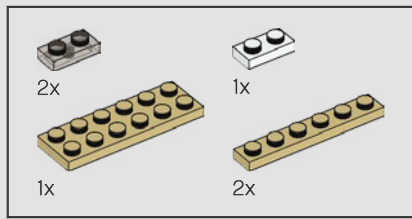

31

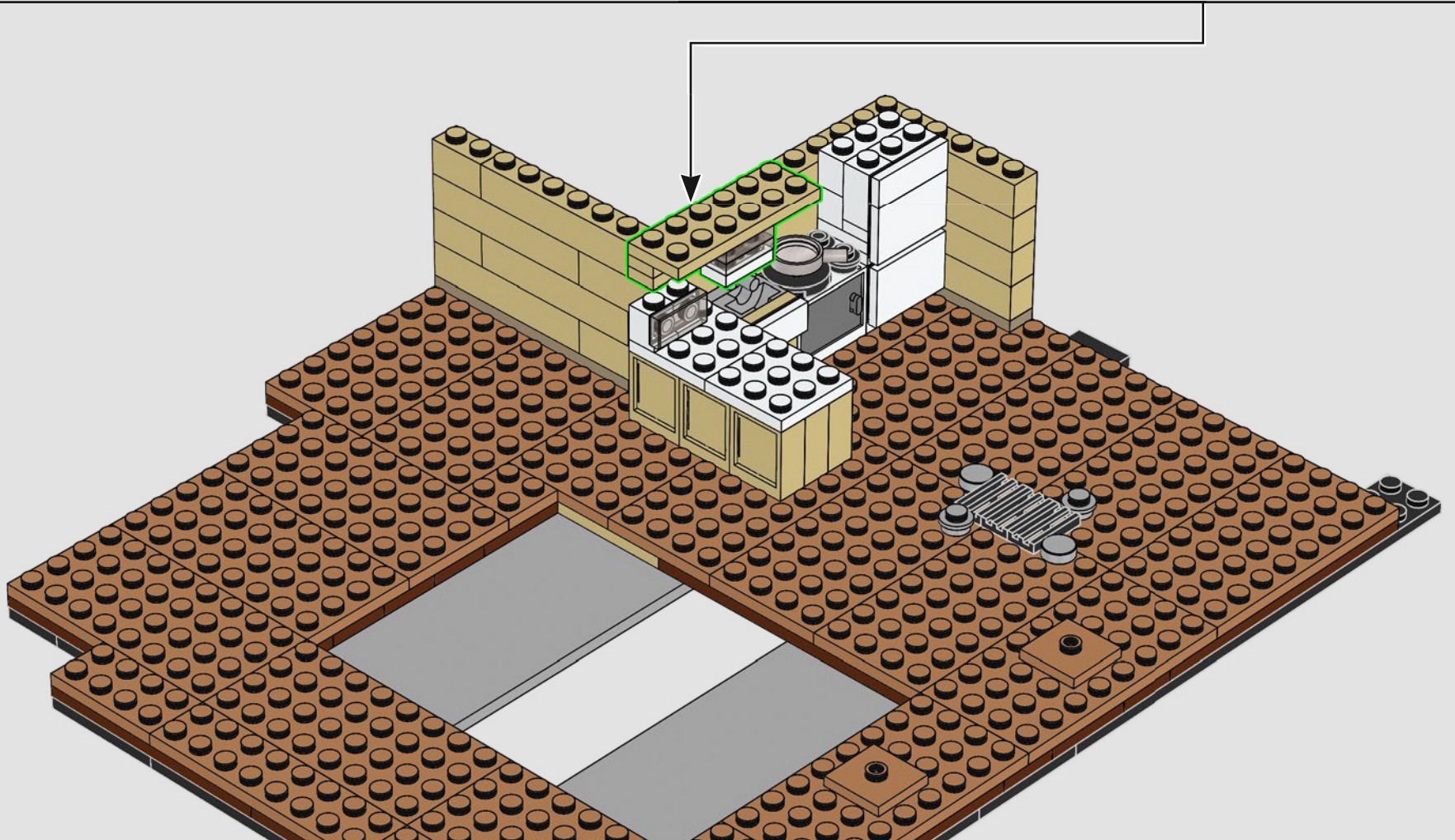
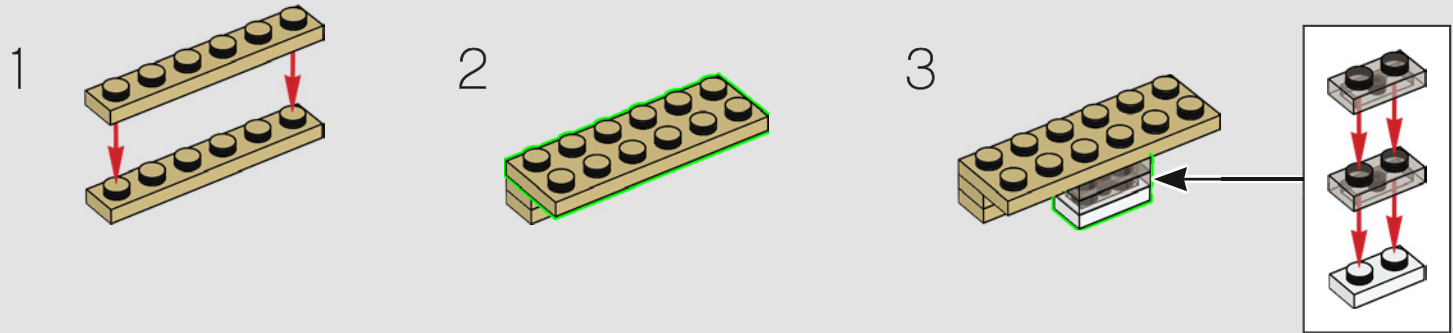

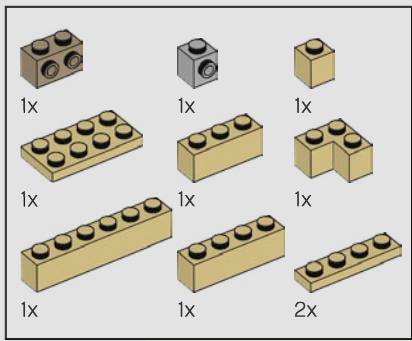

32

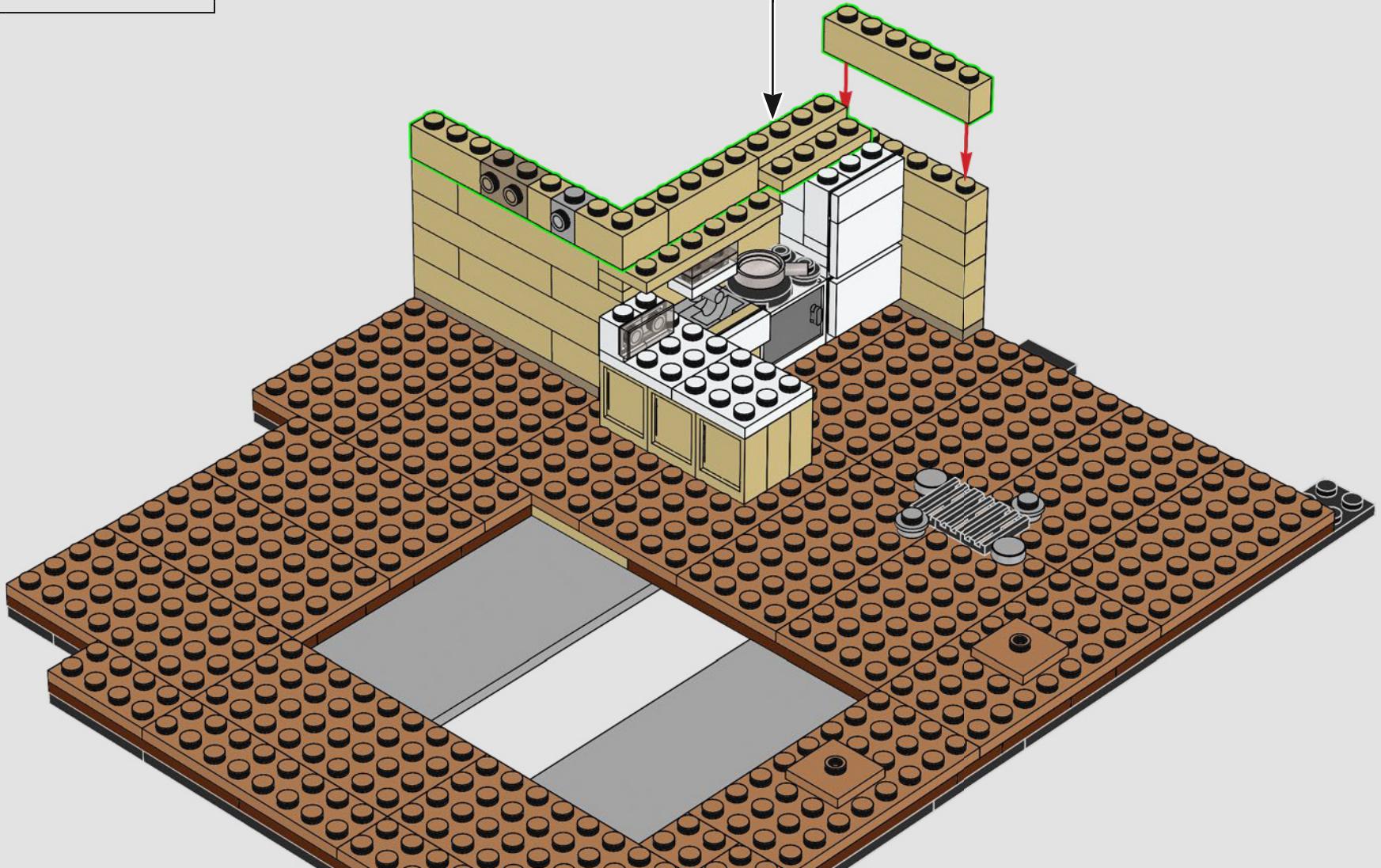
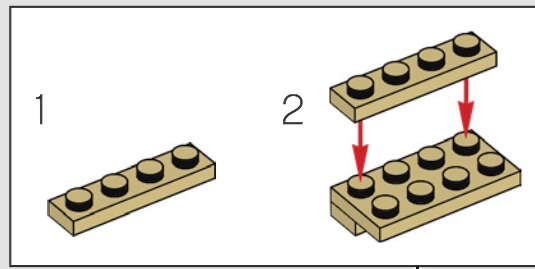



33

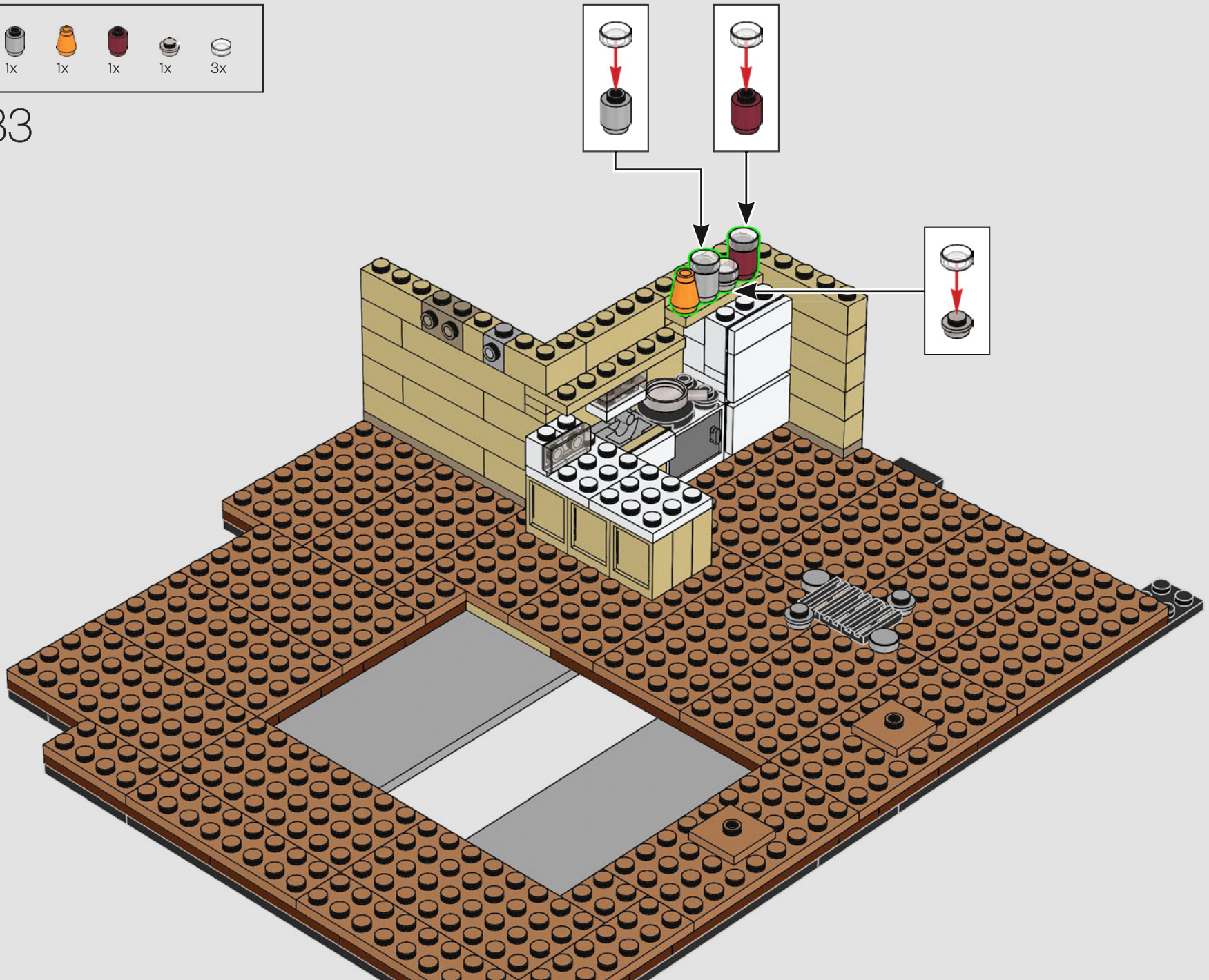

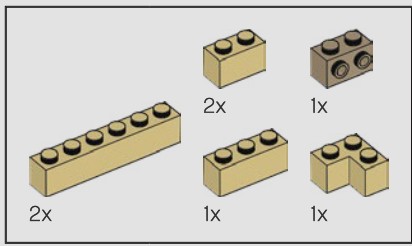

34

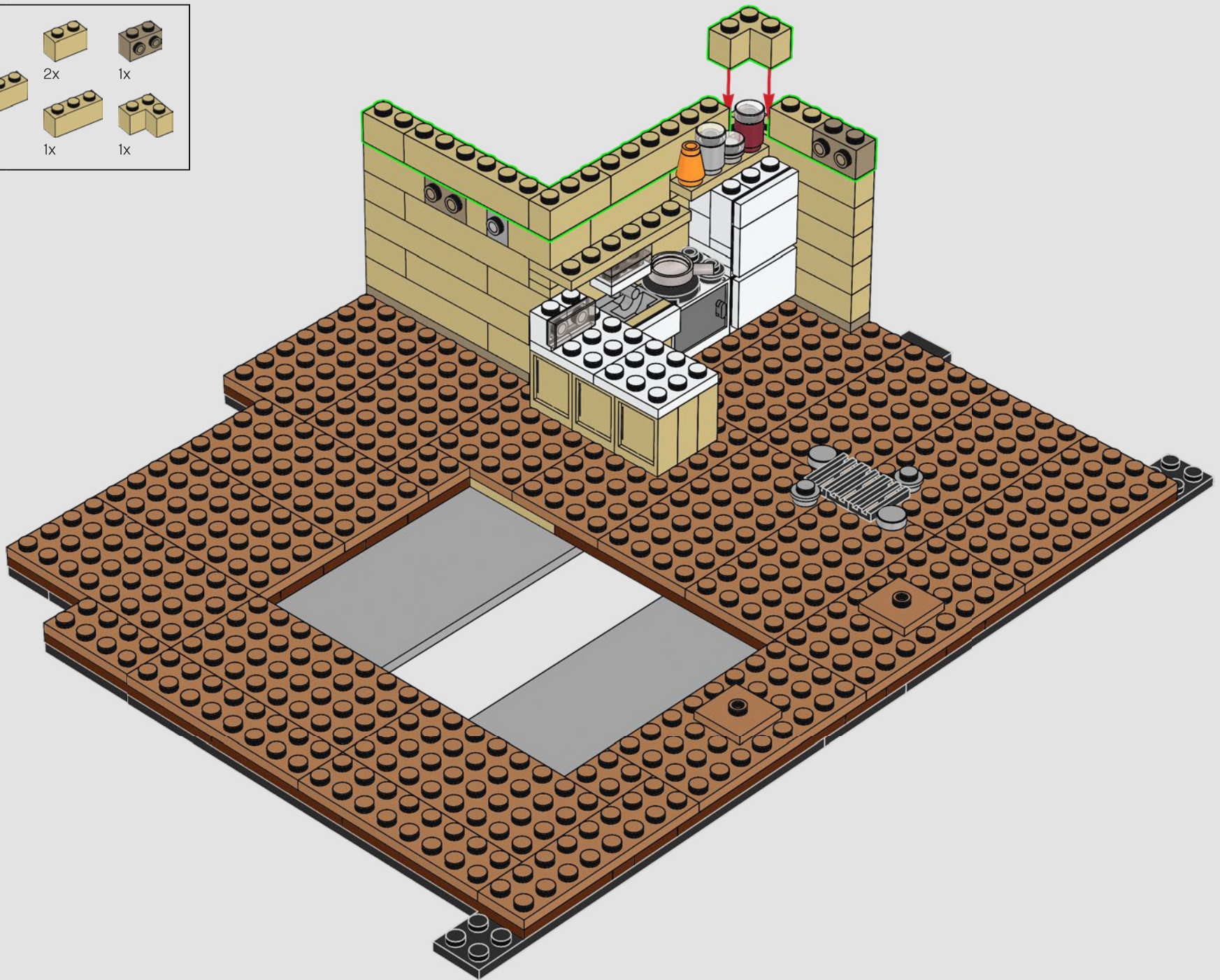

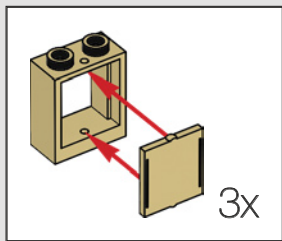
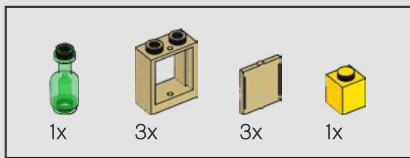

35

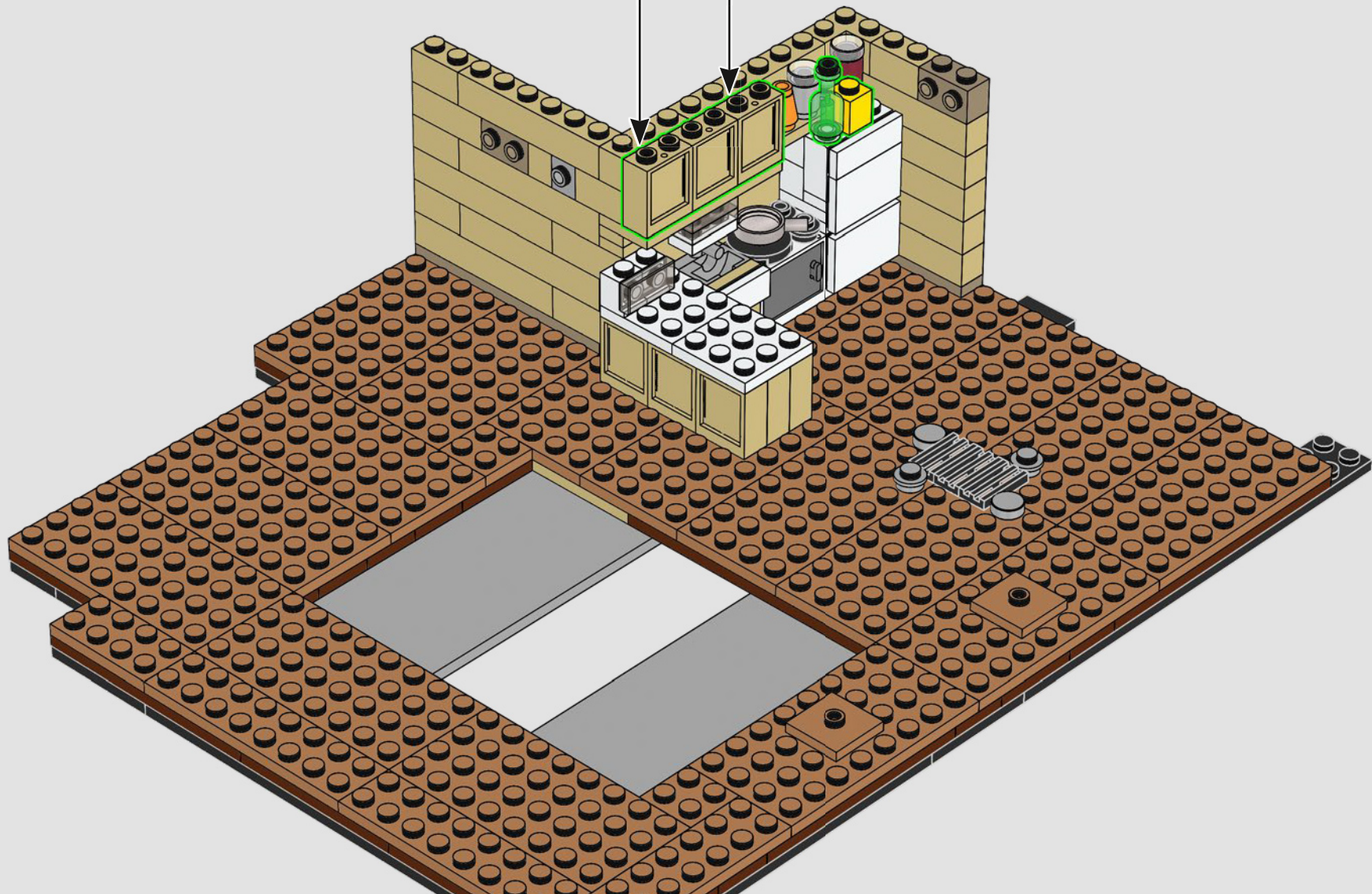

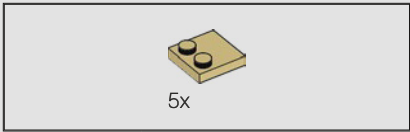

36

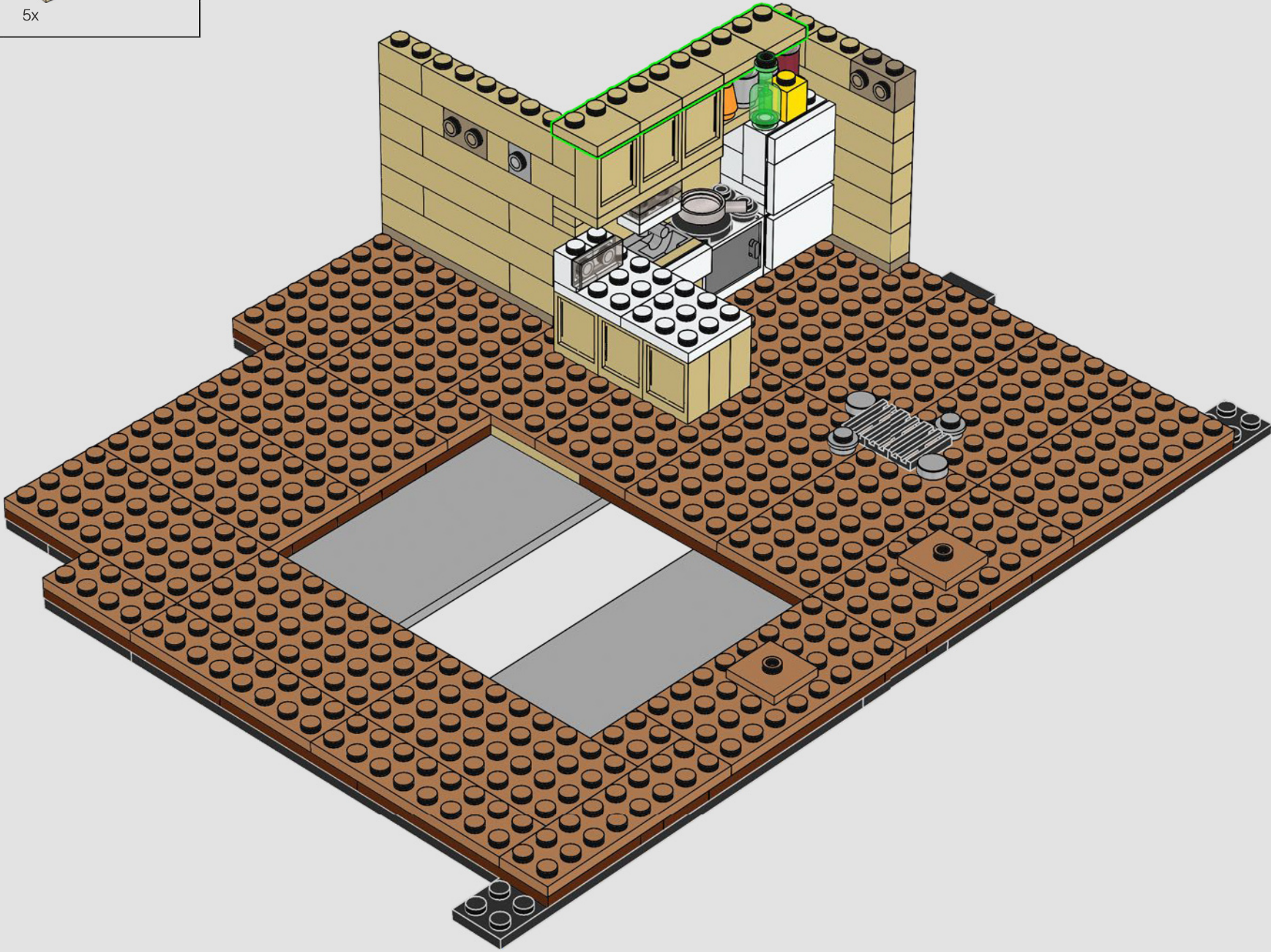

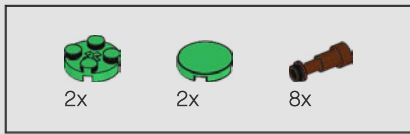

37

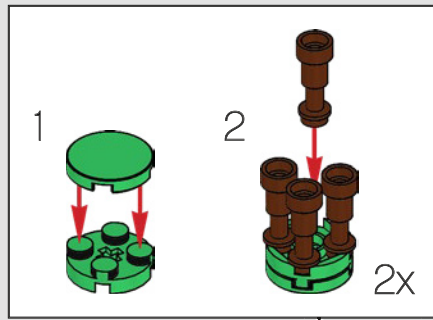

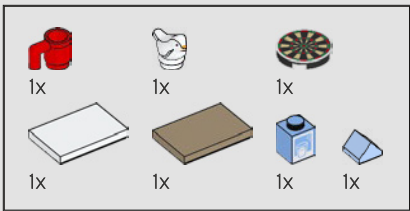

38

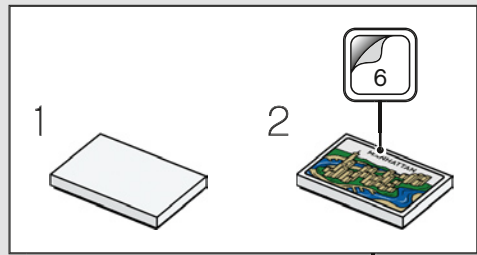
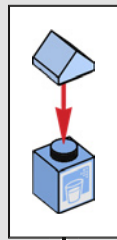
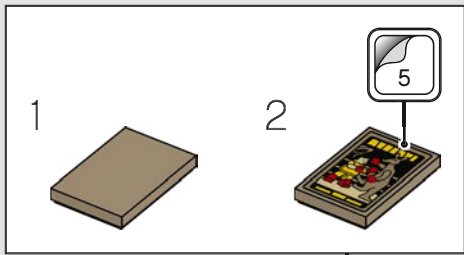

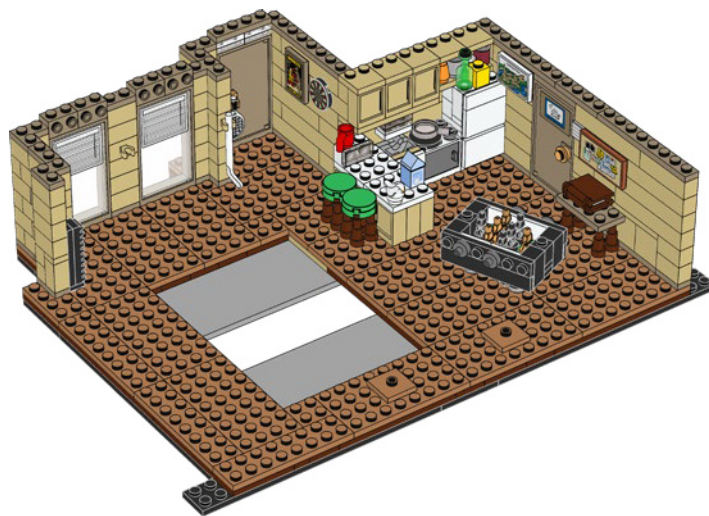

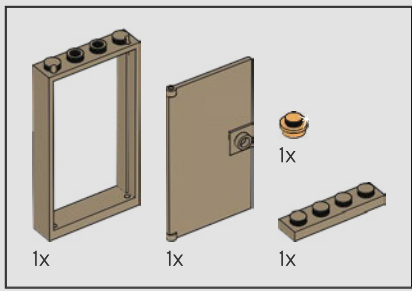

1

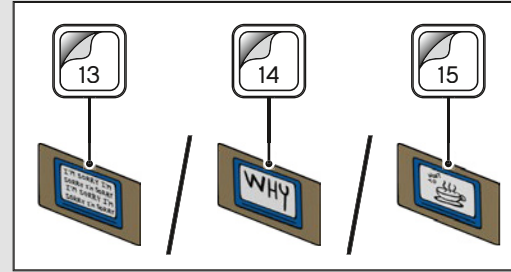
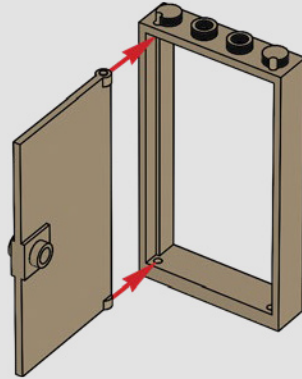

2

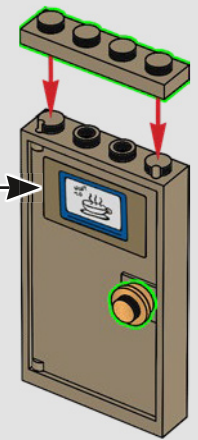

39

Choose between 3 sticker options for the small whiteboard on the back of the entrance door.

Choisissez un autocollant parmi 3 options pour le petit tableau blanc à l'arrière de la porte d'entrée.

Elige entre 3 opciones de calcomanías para el pequeño pizarrón que se encuentra detrás de la puerta de entrada.

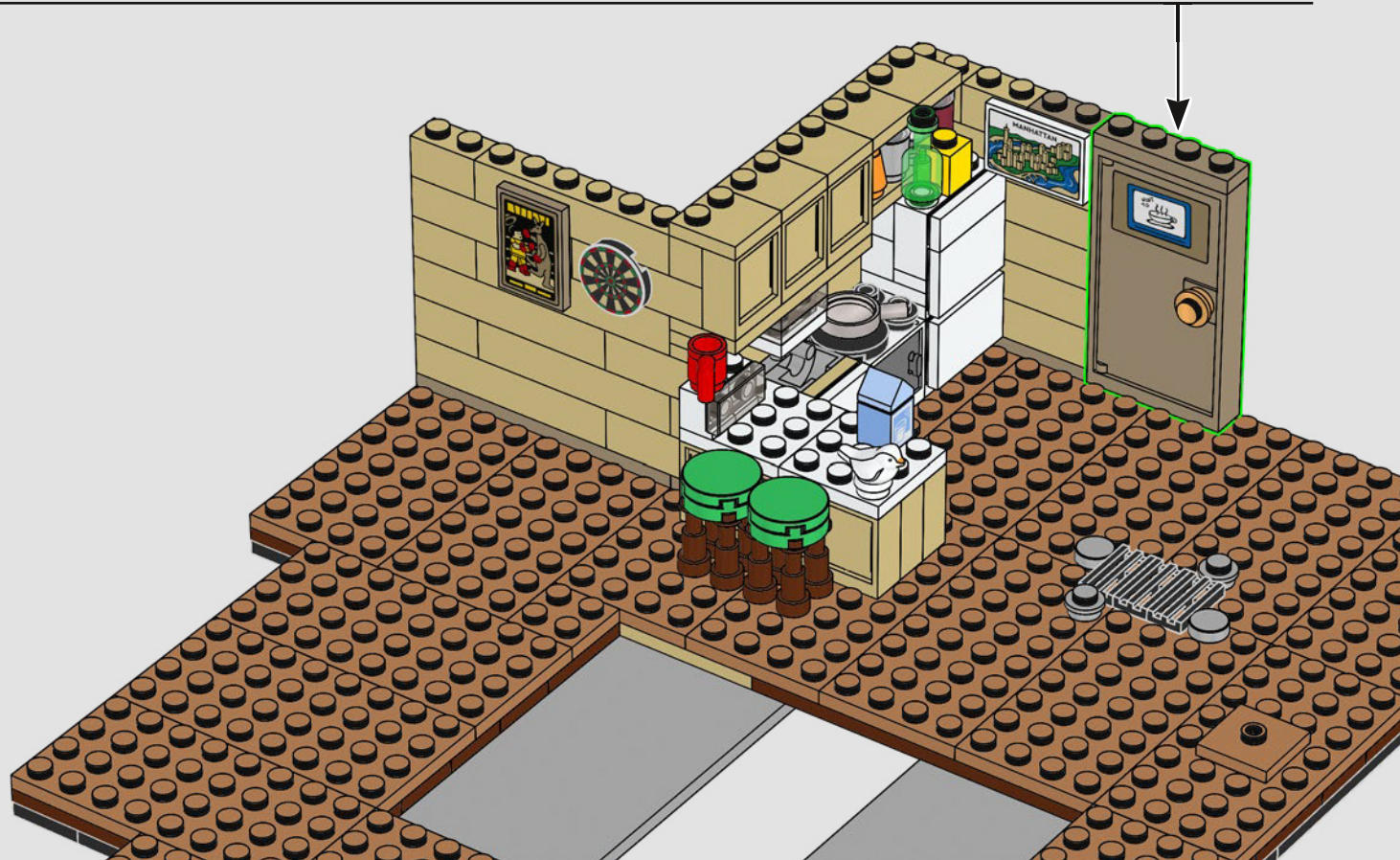

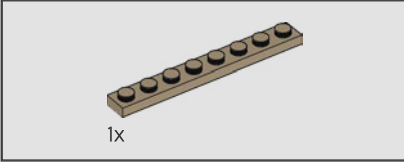
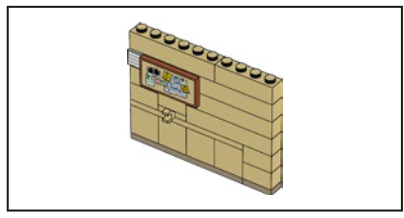

40

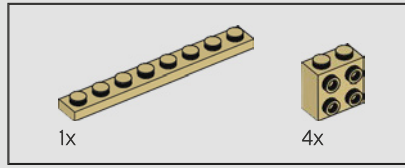
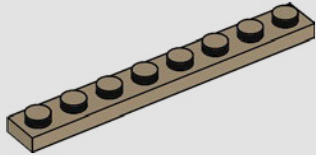

41

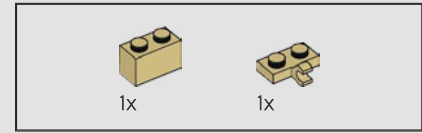
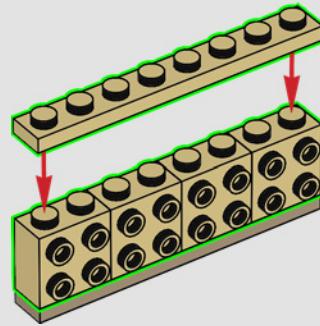

42

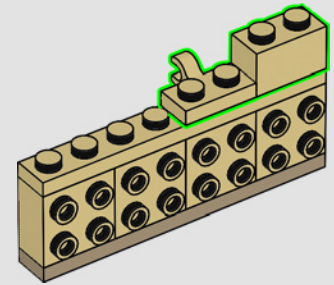

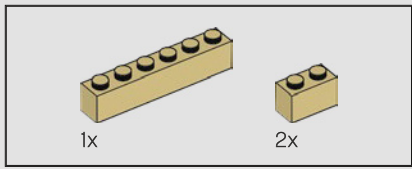

43

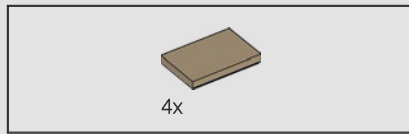
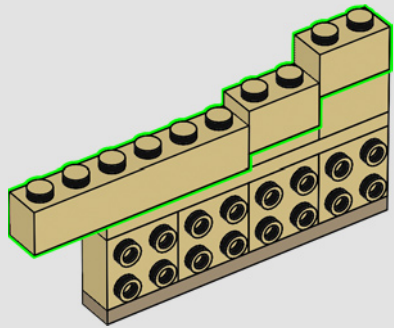

44

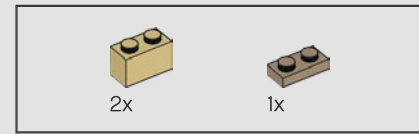
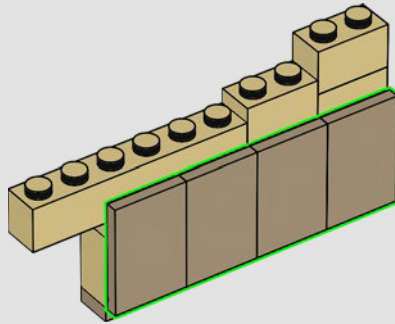

45

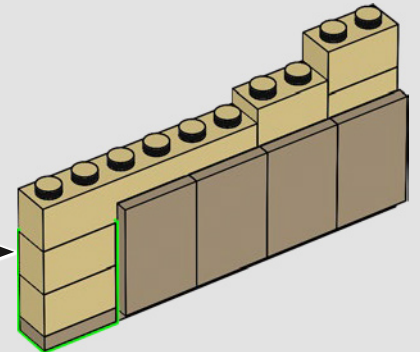
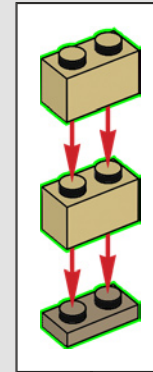

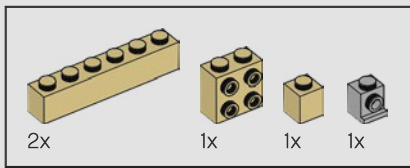

46

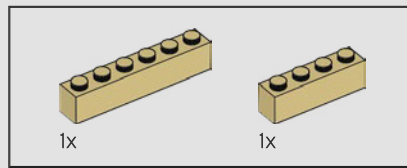
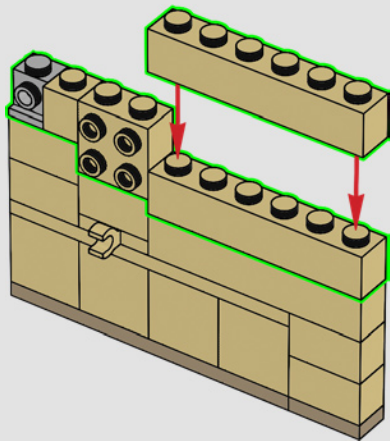

47

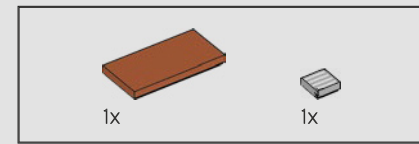
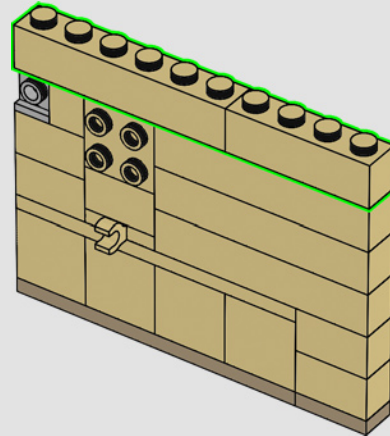

48

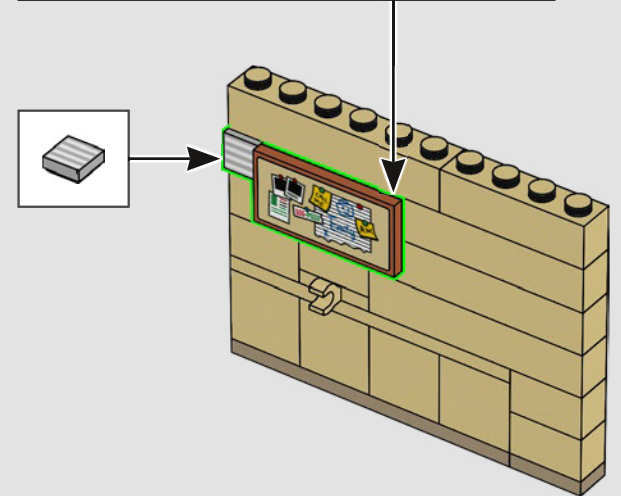
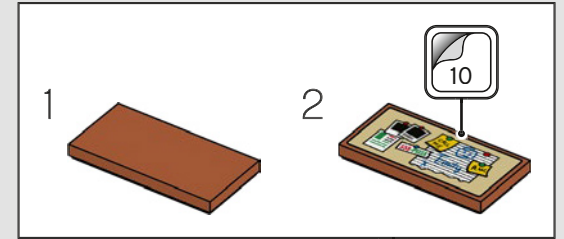

49

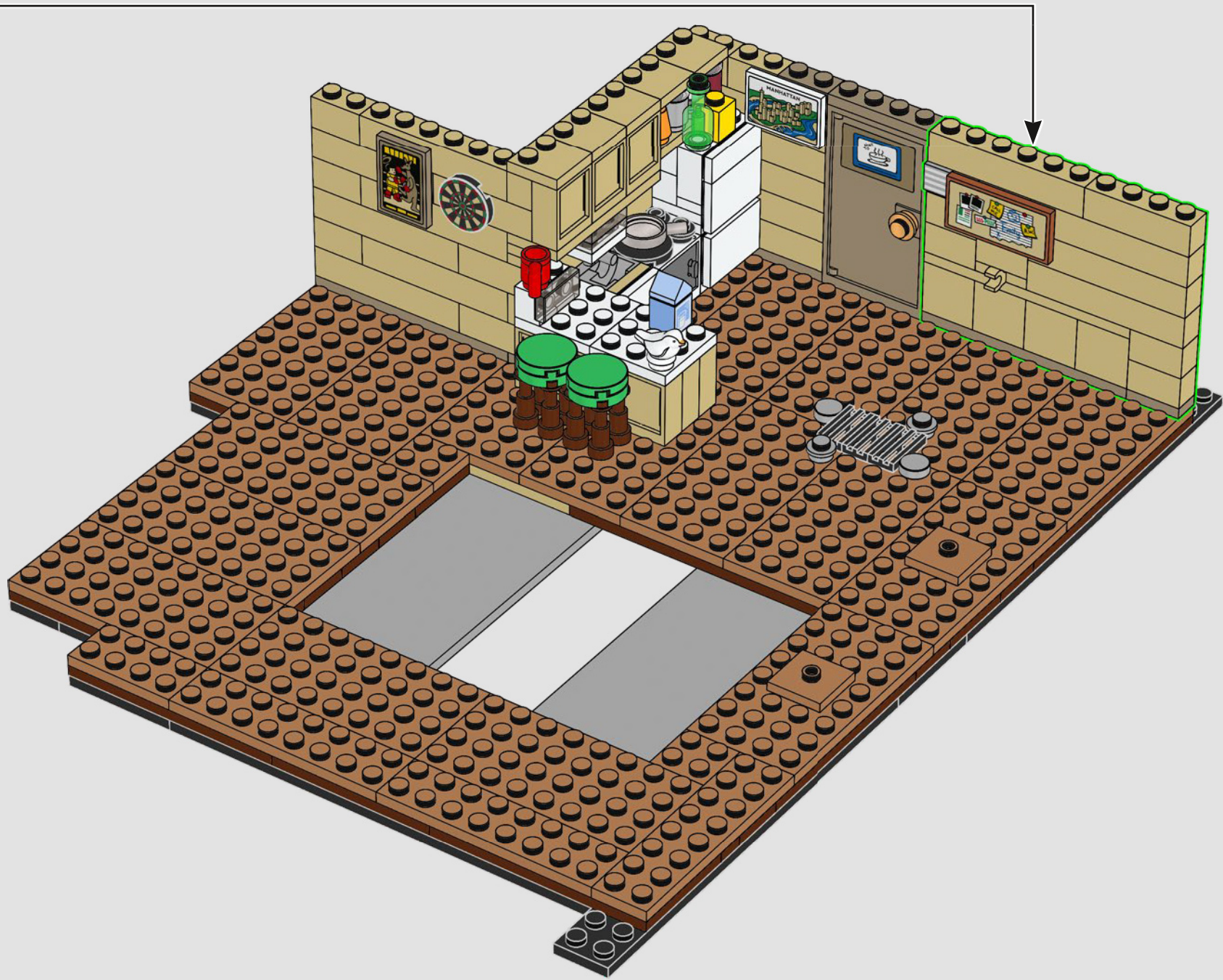

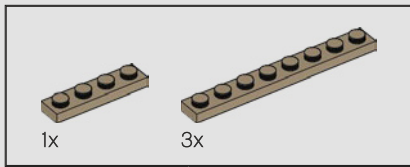

50



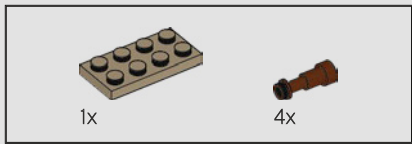

51

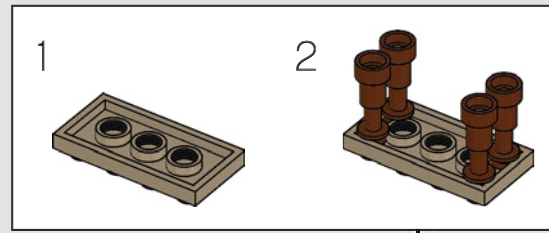

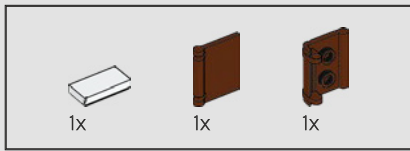

52

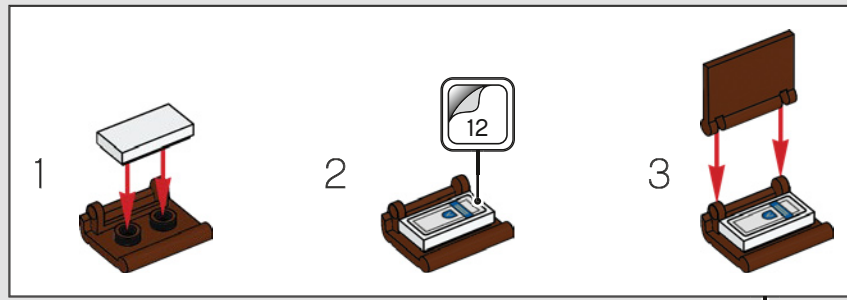

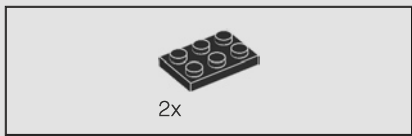

53

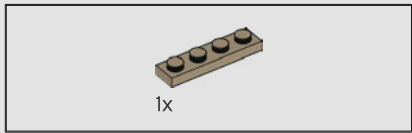
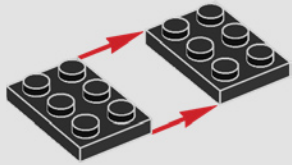

54

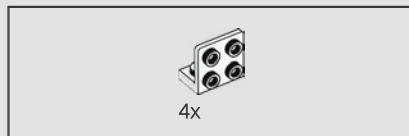
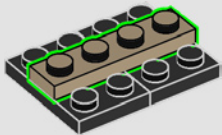

55

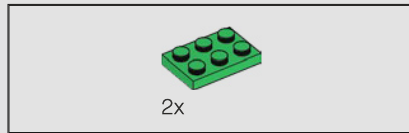
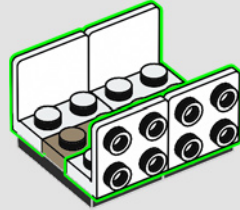

56

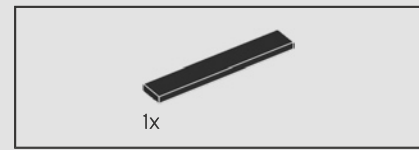
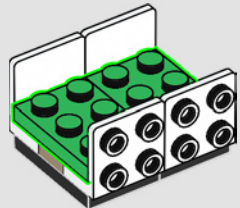

57

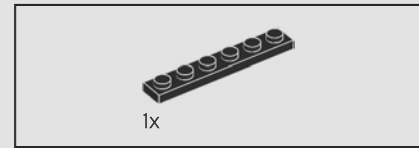
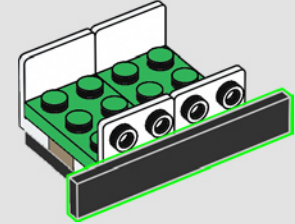

58

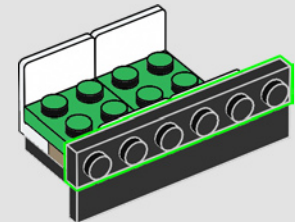

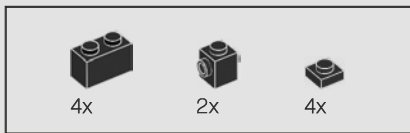

59

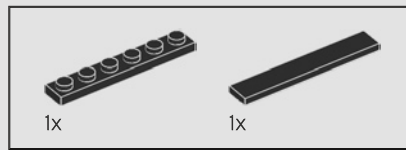
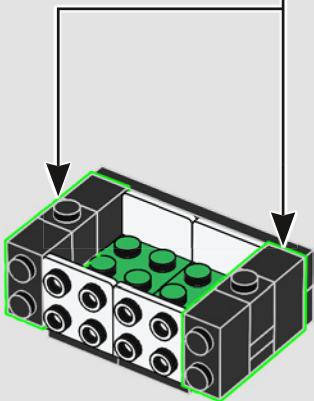
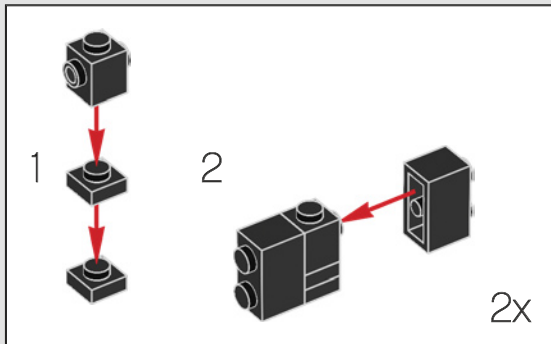

60

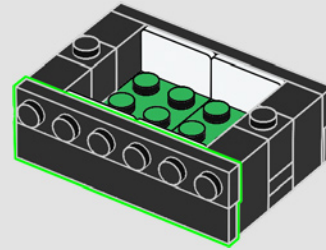

61

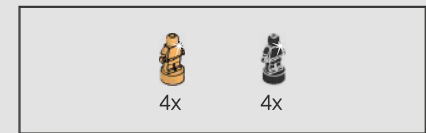
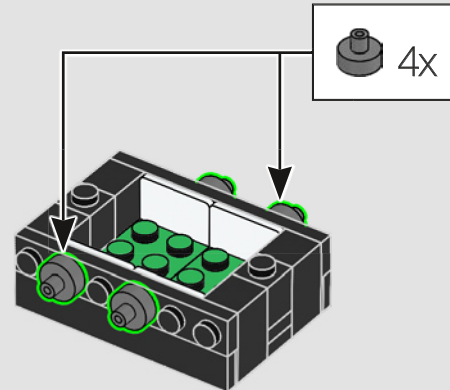

62

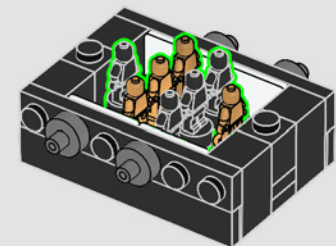

63



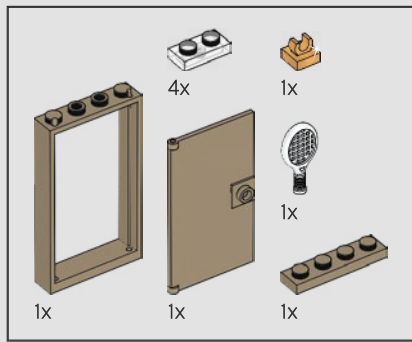

64

1

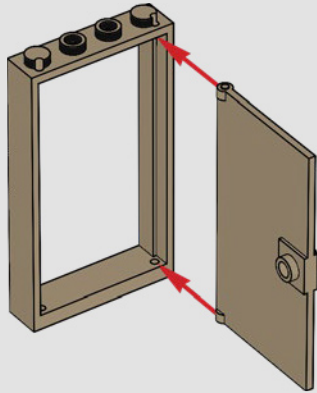

2

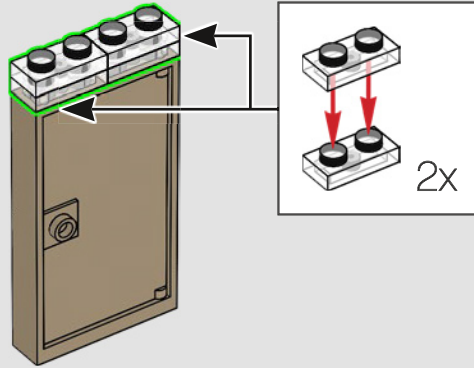

3

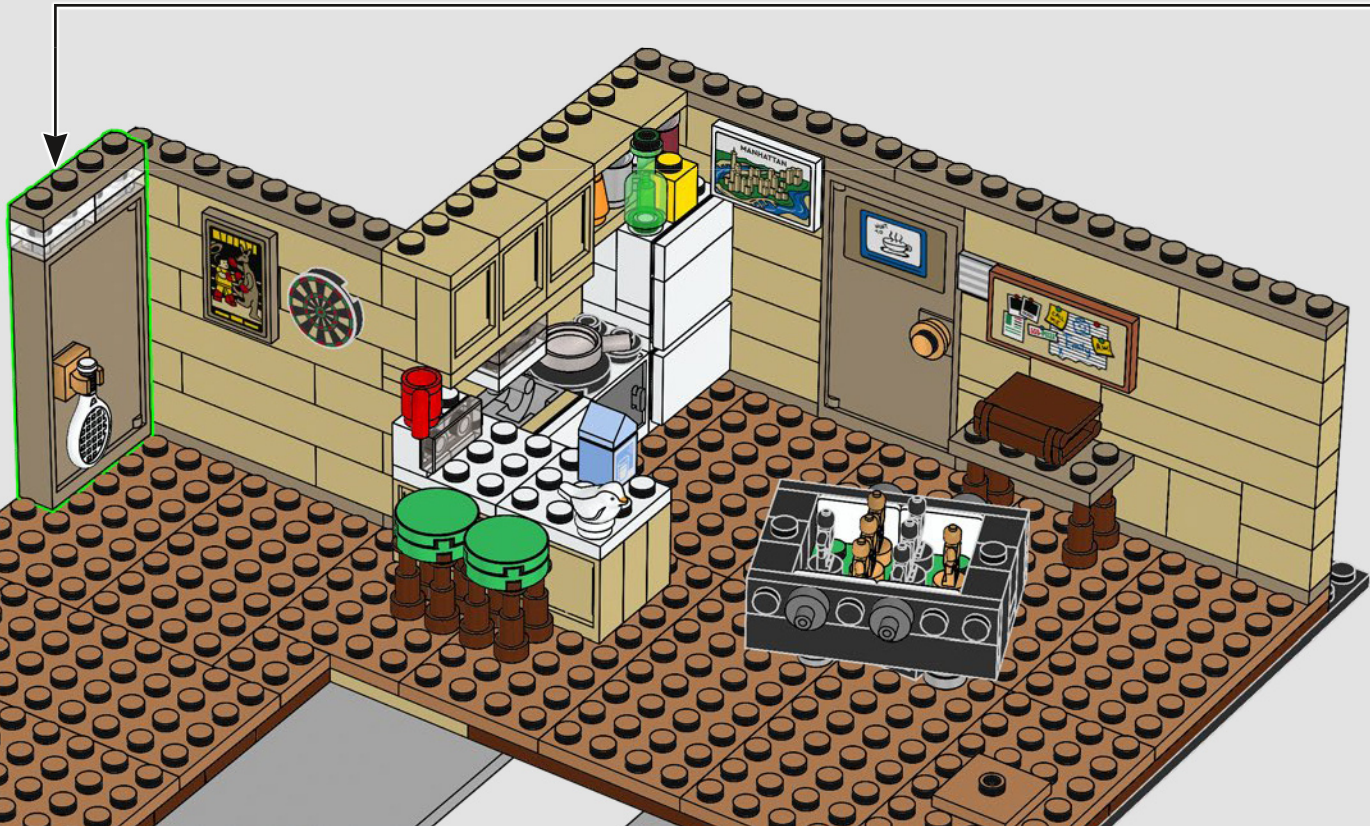
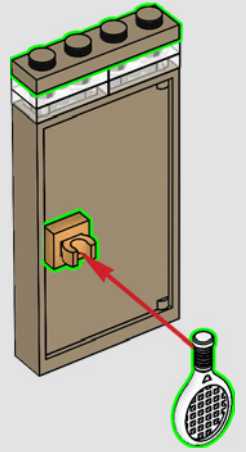

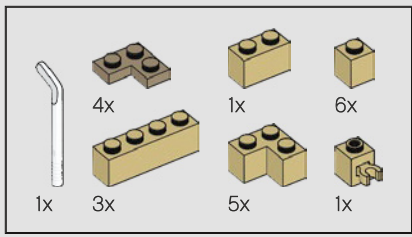

65

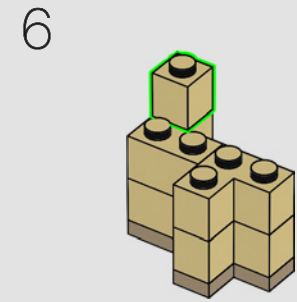
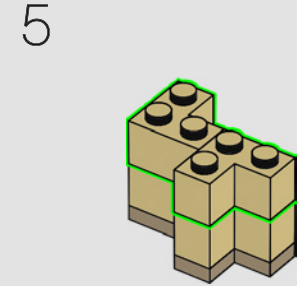
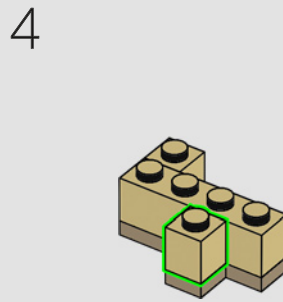
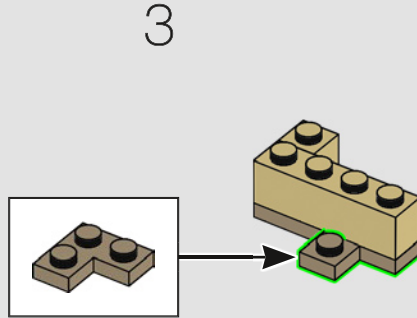
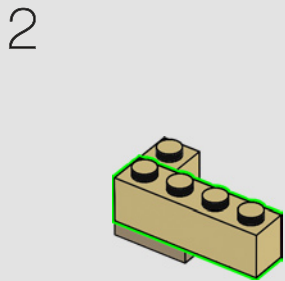
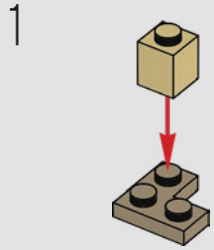

7

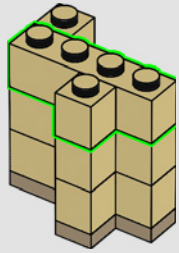

8

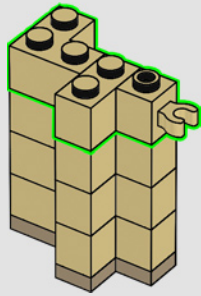

9

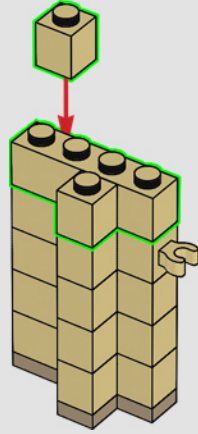

10

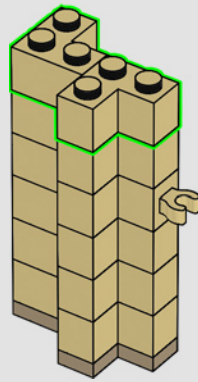

11

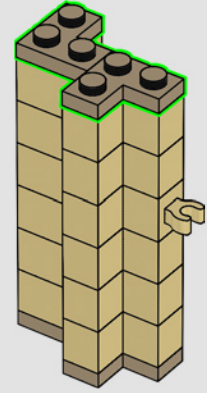

12

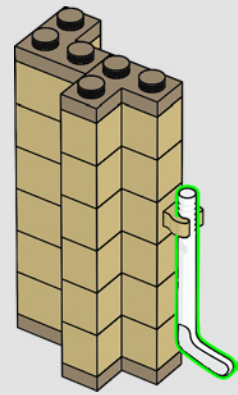



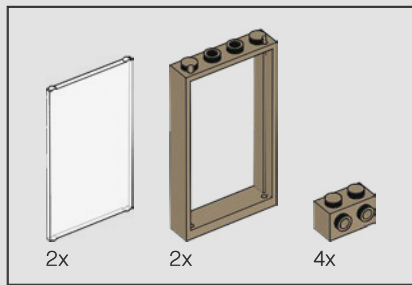

66

1

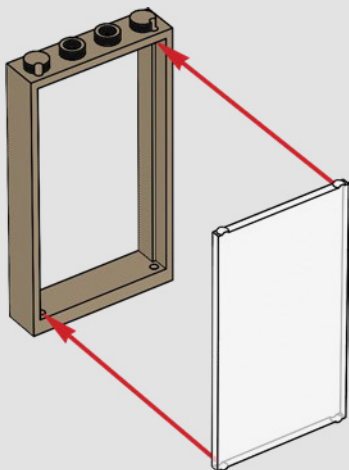

2

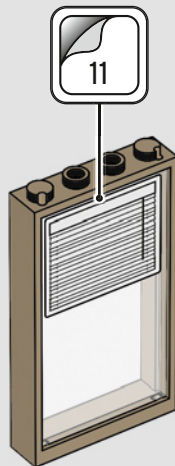

3

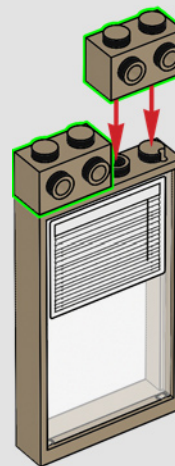

2x

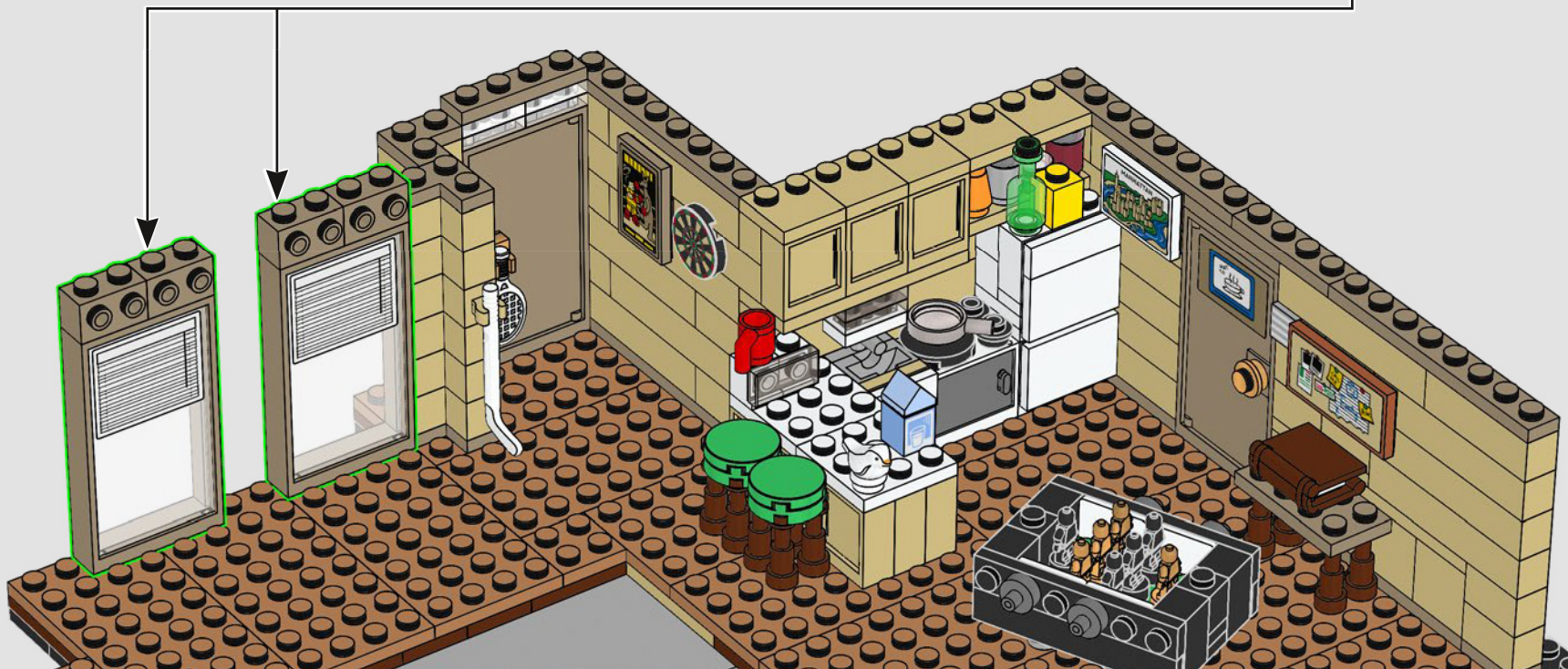

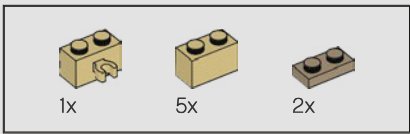

67

1

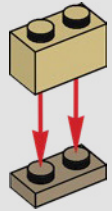

2

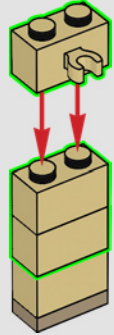

3

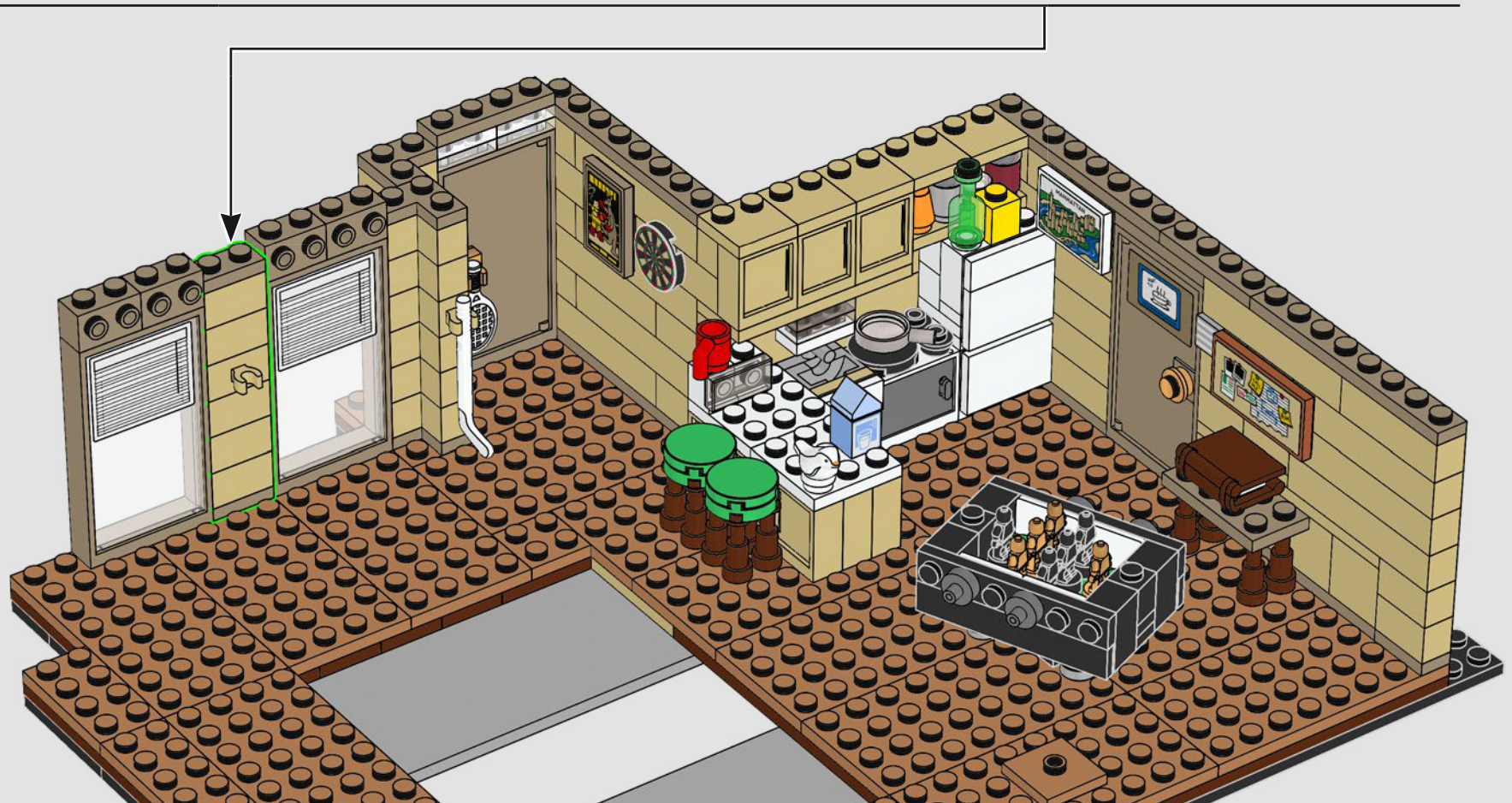
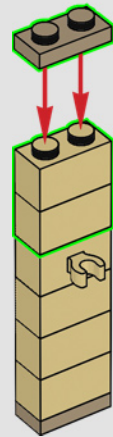

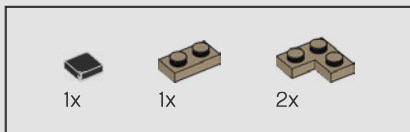

68



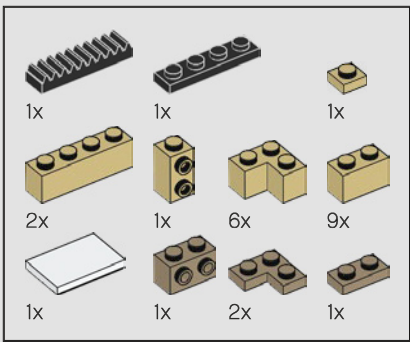

69

1

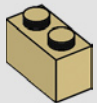

2

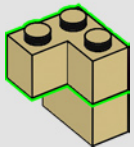

3

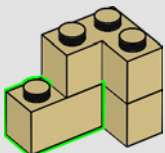

4

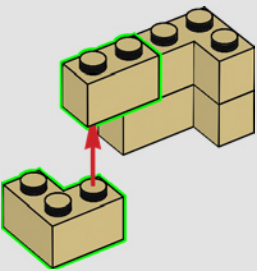

5

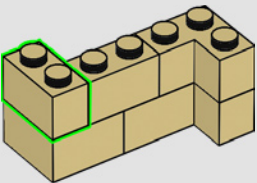

6

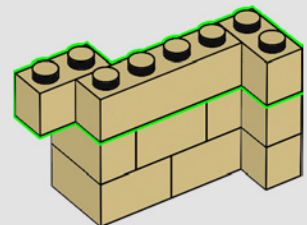

7

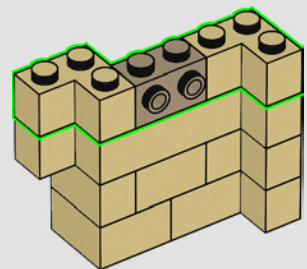

8

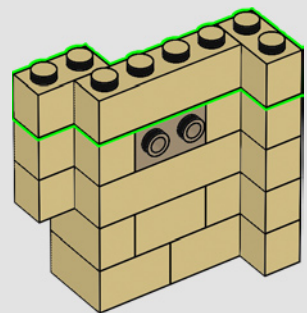

9

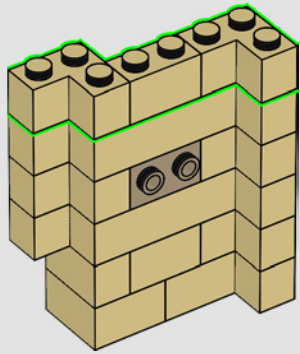

10

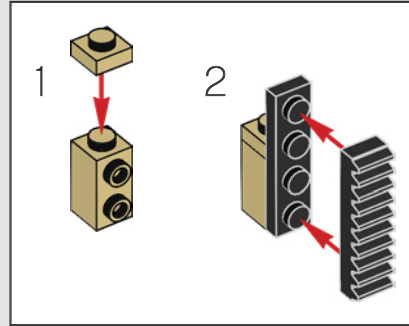
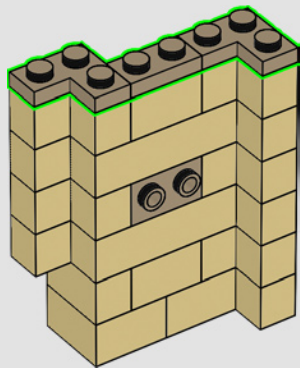

11

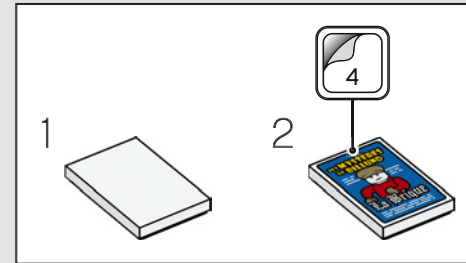
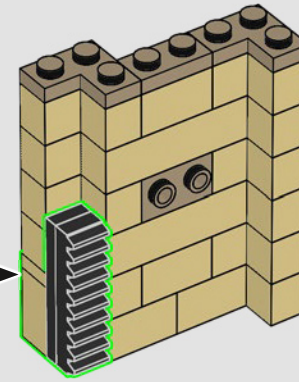

12

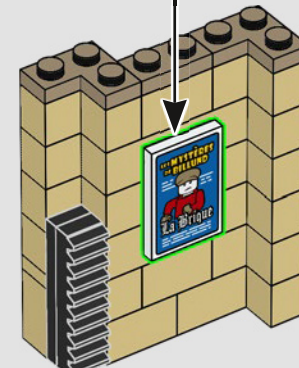

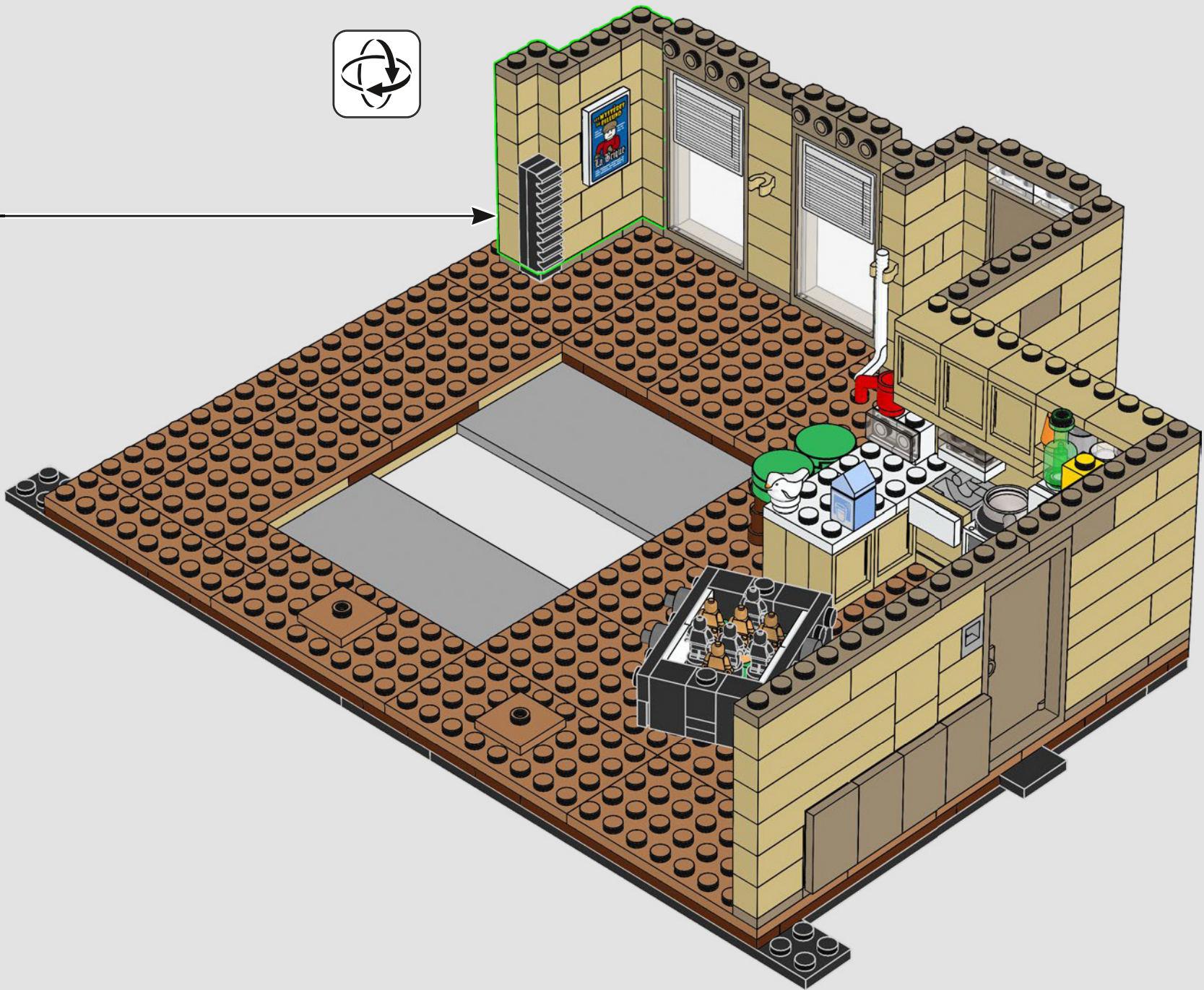

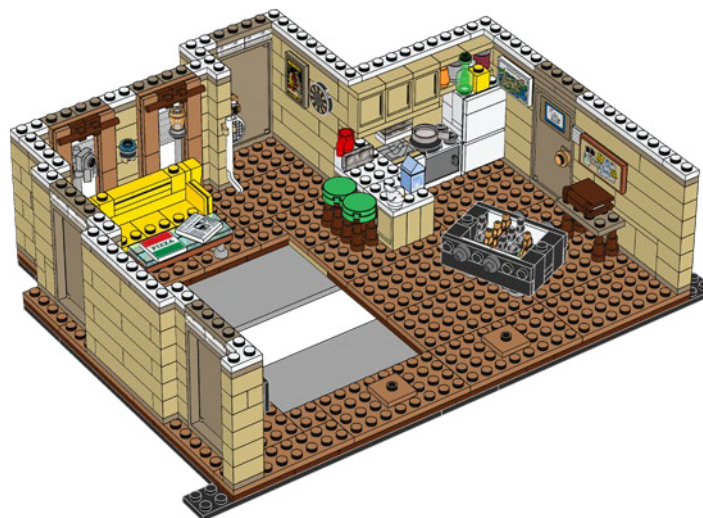

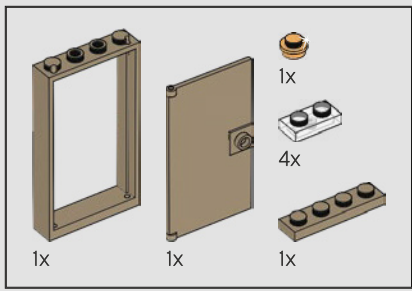

70

1

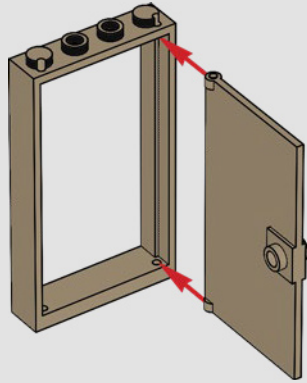

2

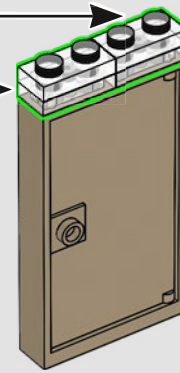
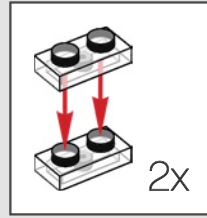

3

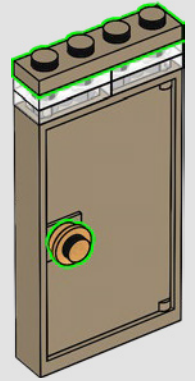

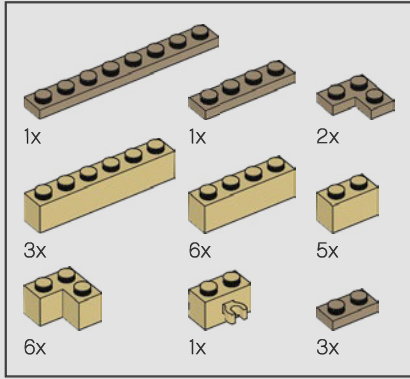
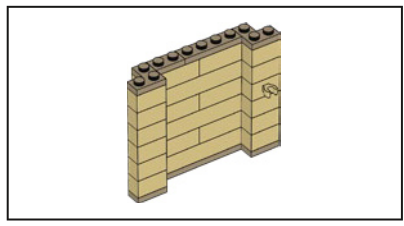

71

1

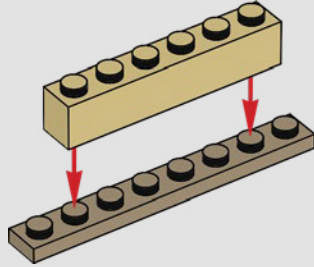

2

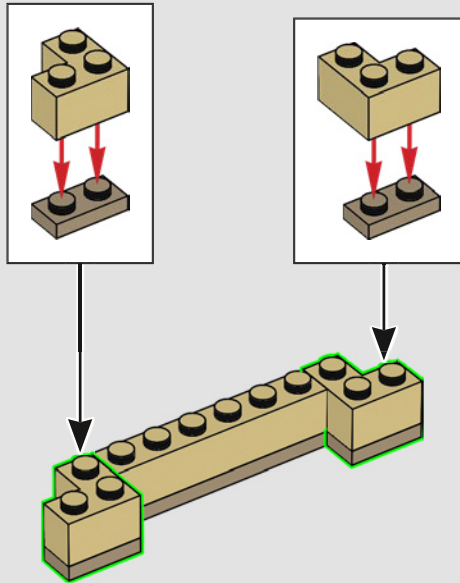

3

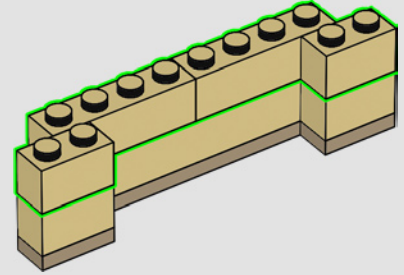

4

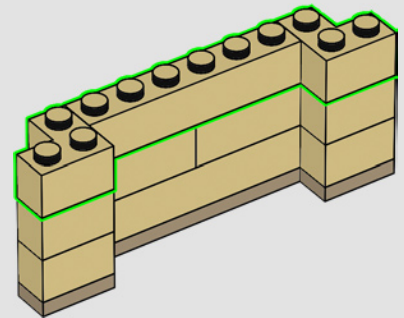

5

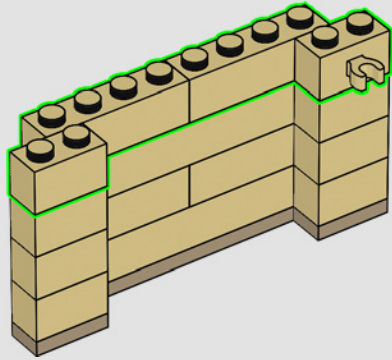

7

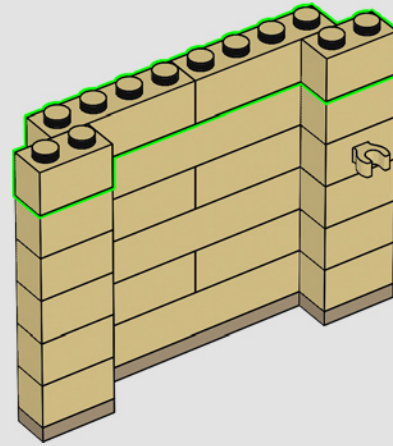

6

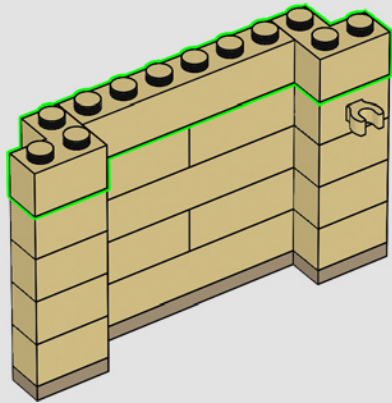

8

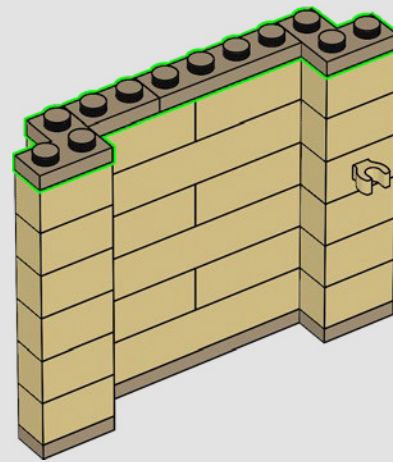

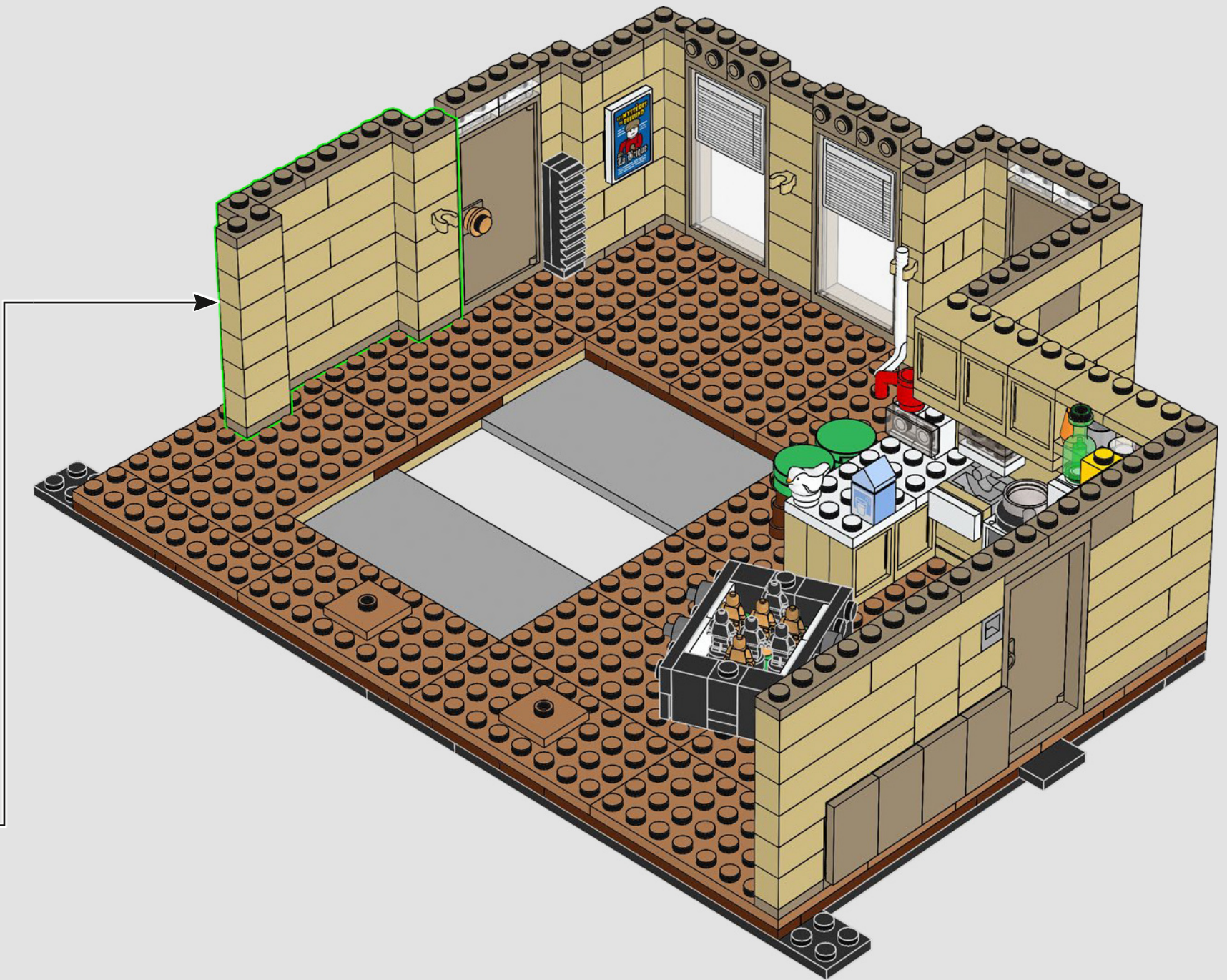

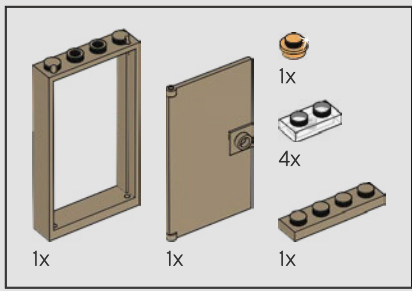

72

1

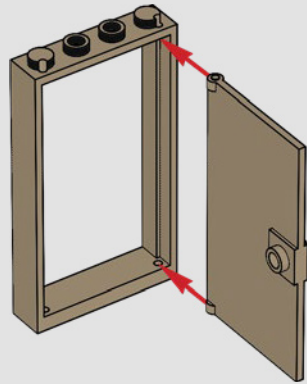

2

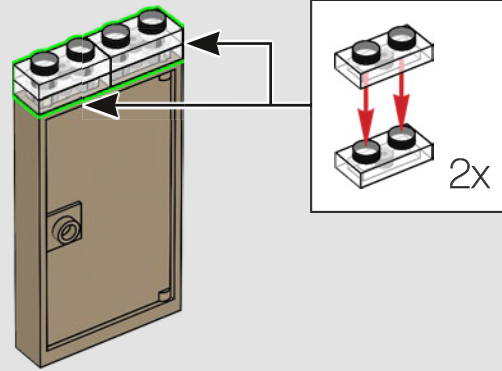

3

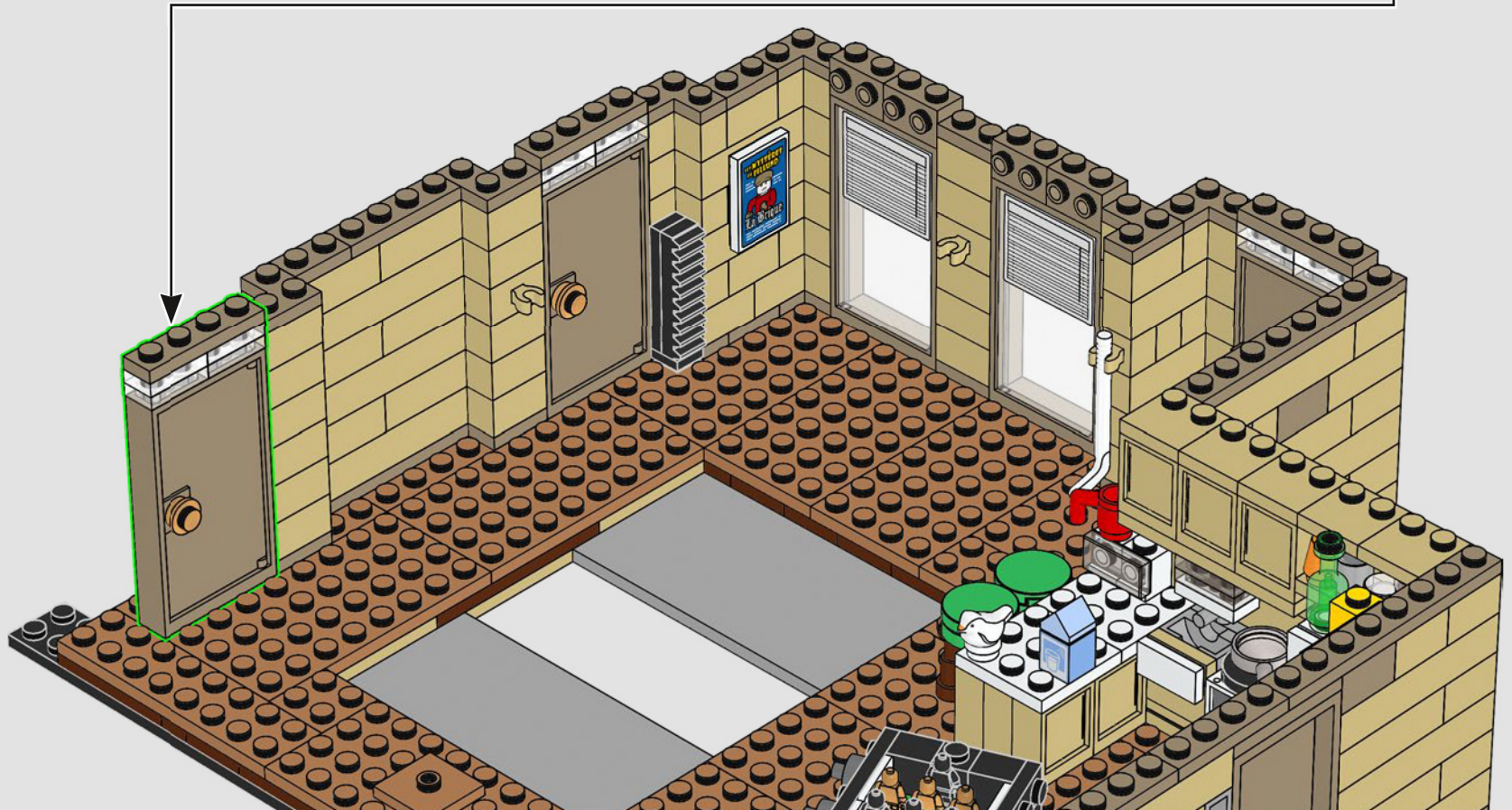
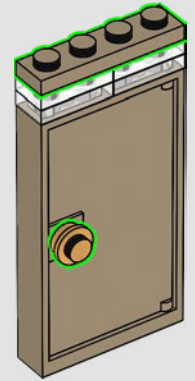

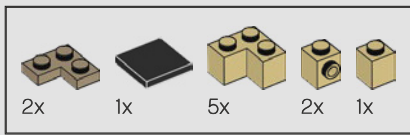

73

1

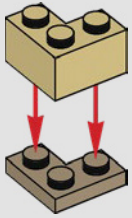

2

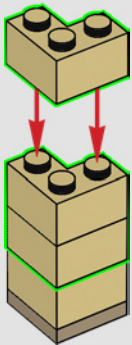

3

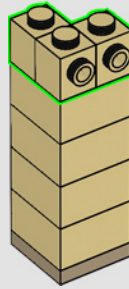

4

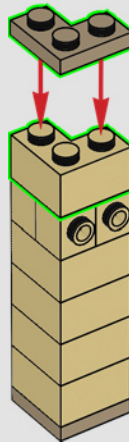

5

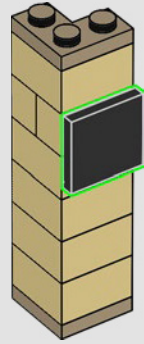

6

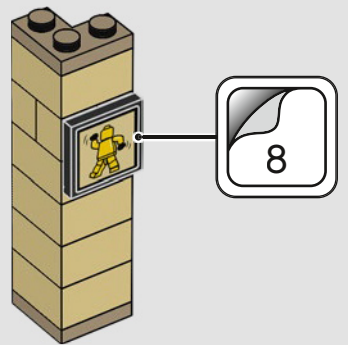

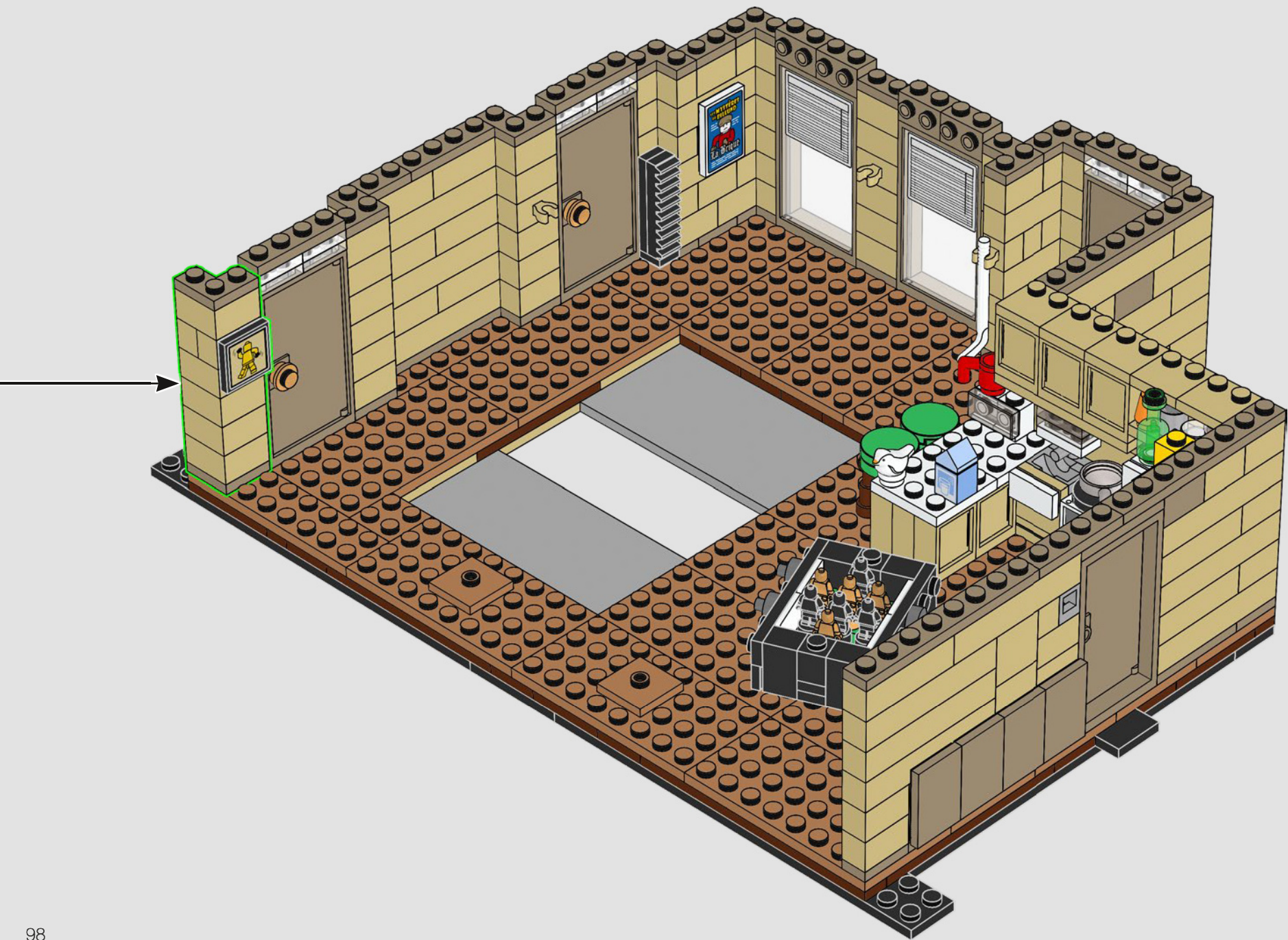

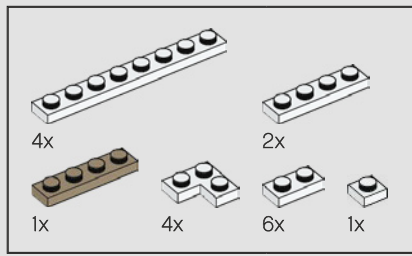

74





75



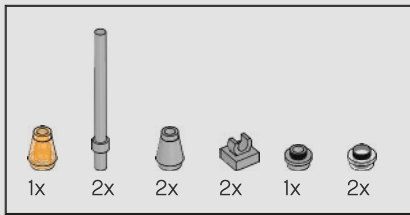

76

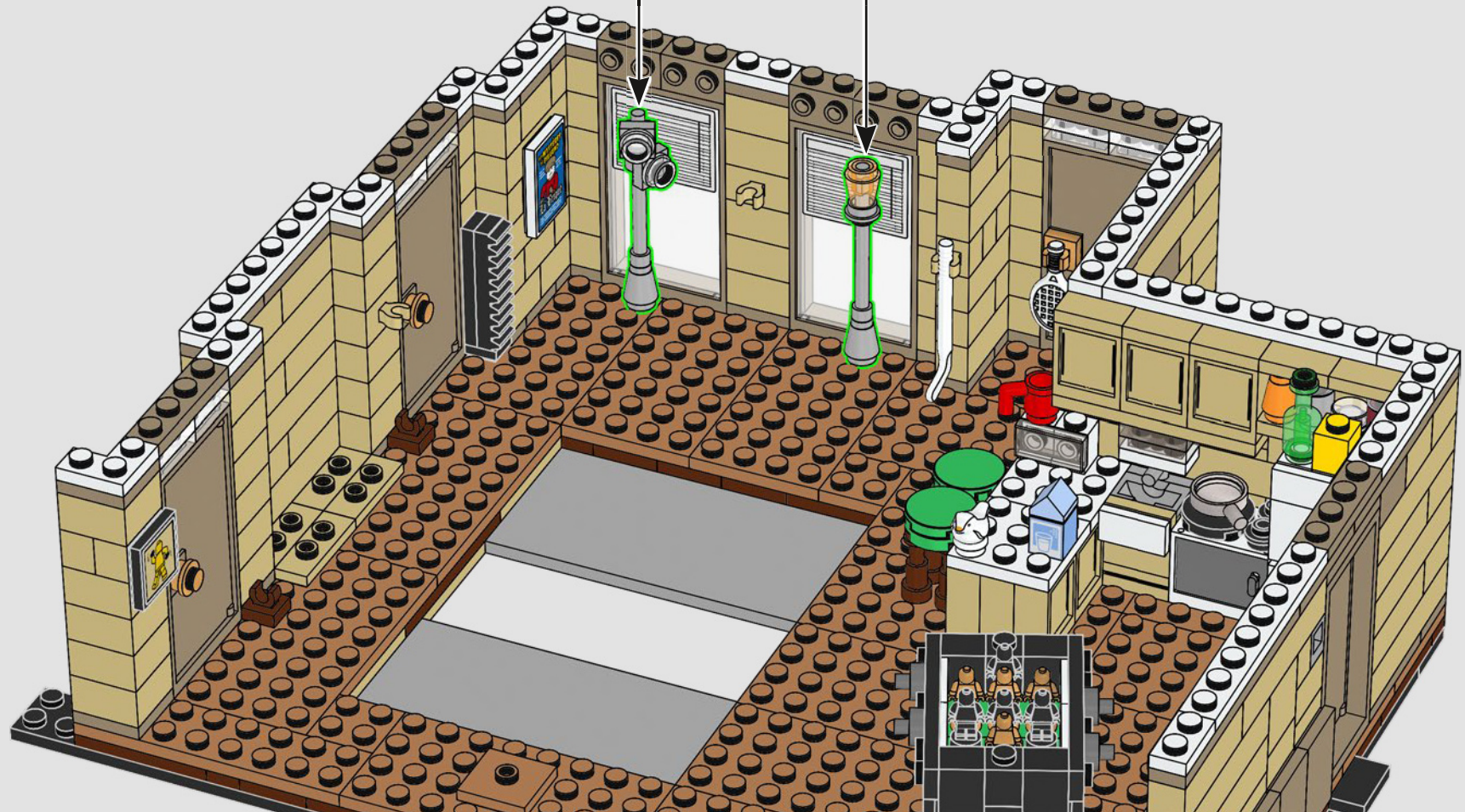
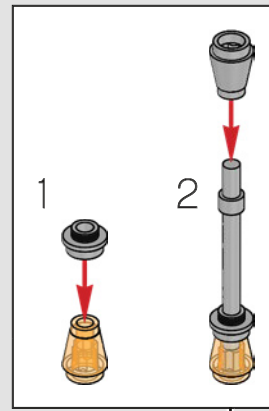
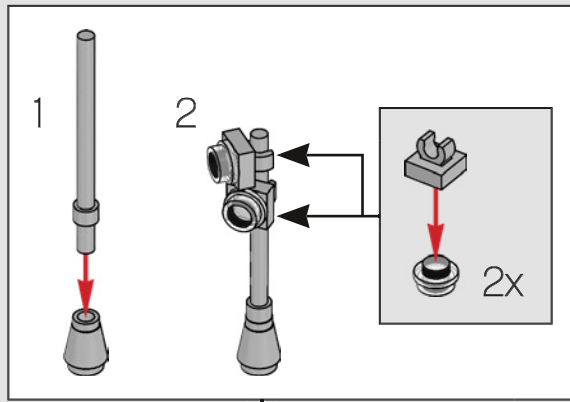

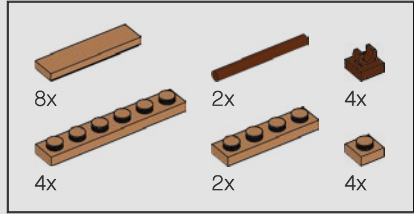
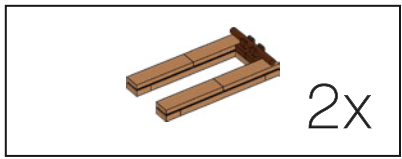

77

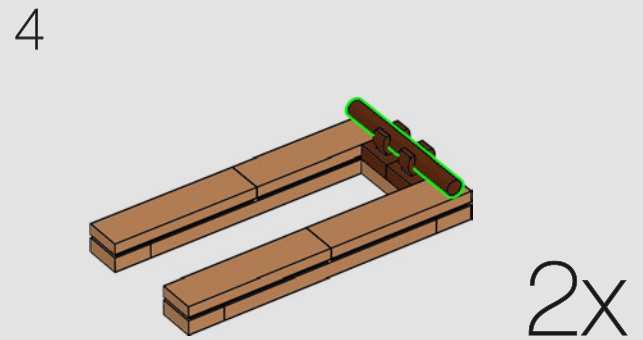
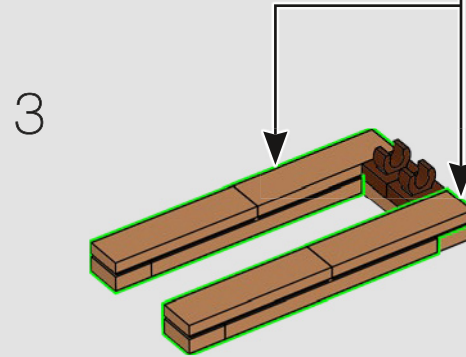
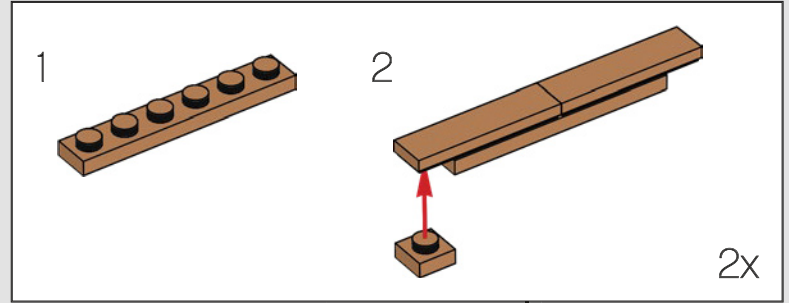
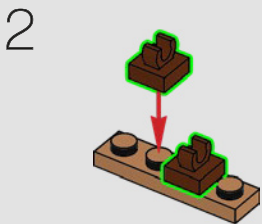
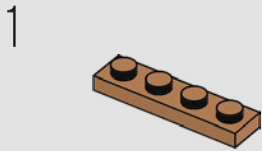



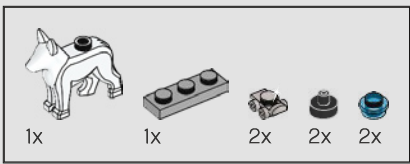

78

• The white dog statue, 'Pat the Dog,' in the corner.

• La statue du chien blanc, « Pat le chien », dans le coin.

• En el rincón hay un perro blanco de cerámica llamado Pat.

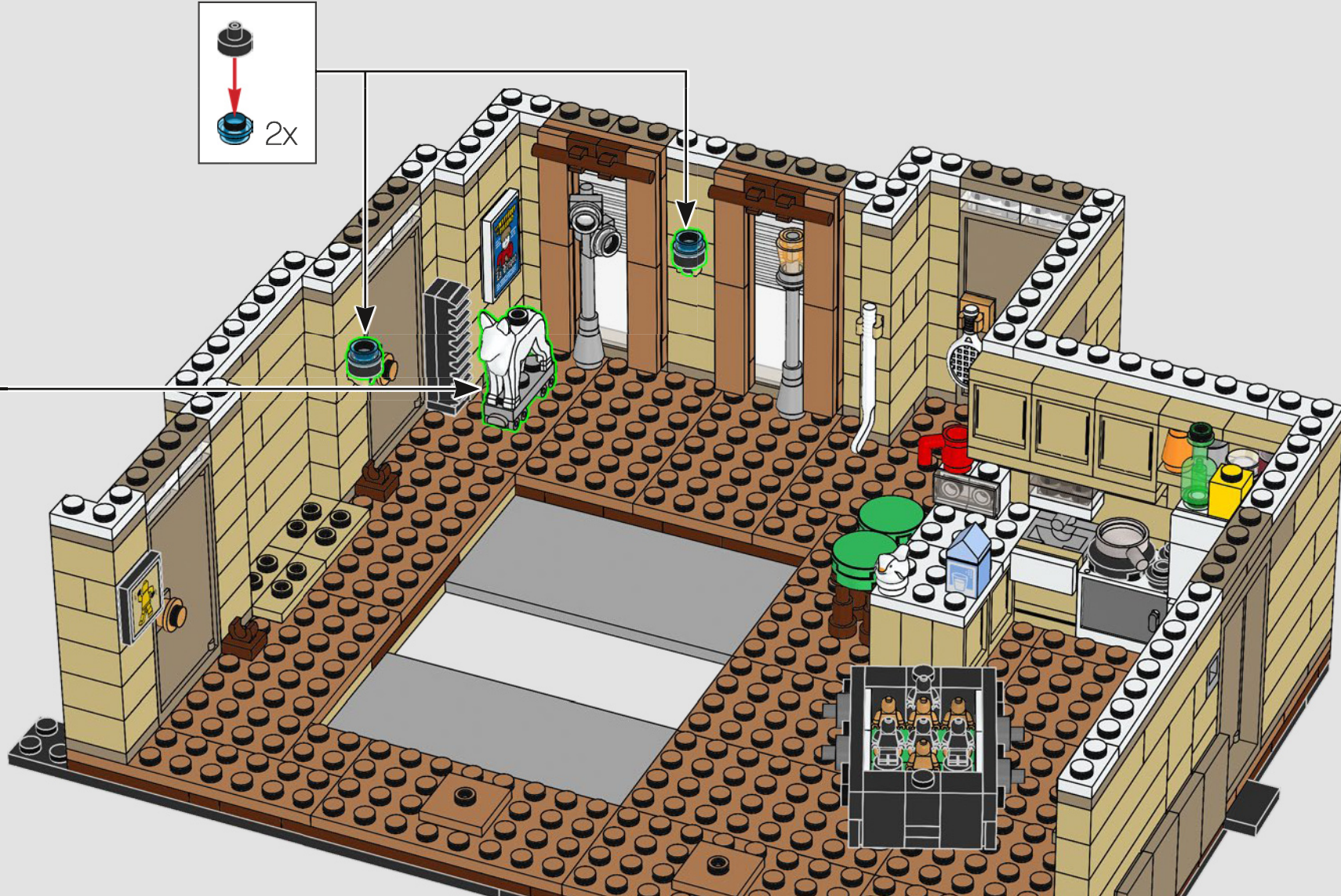
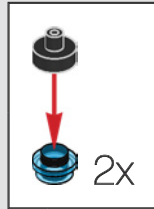
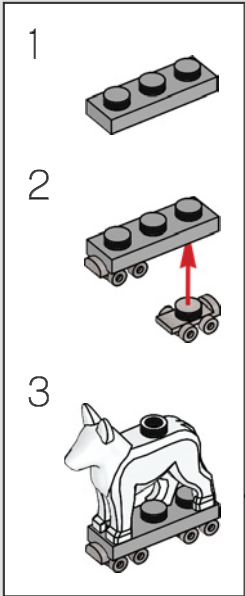

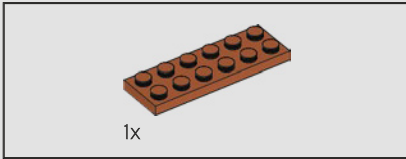
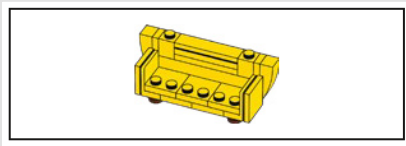

79

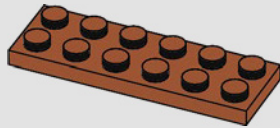

80

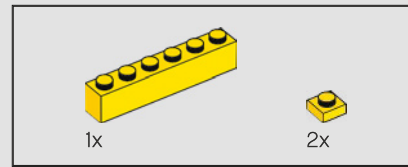
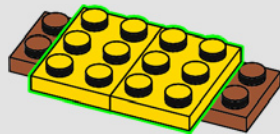

81

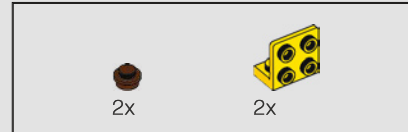
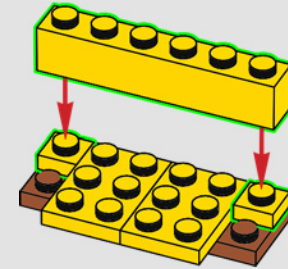

82

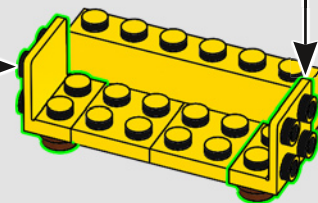
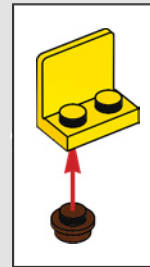
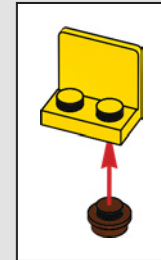

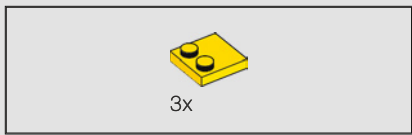

83

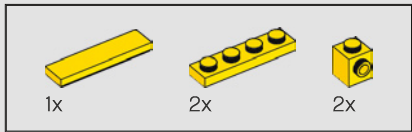
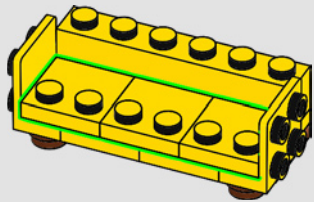

84

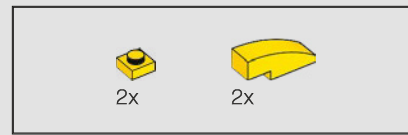
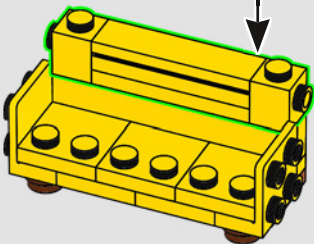
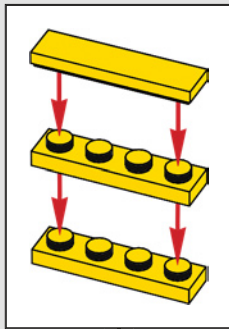

85

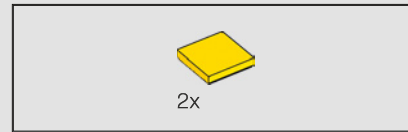
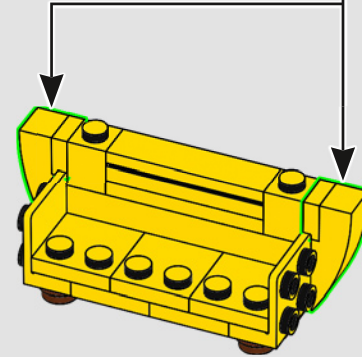
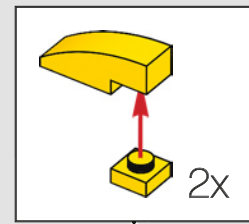

86

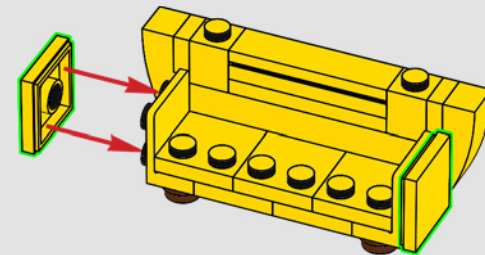

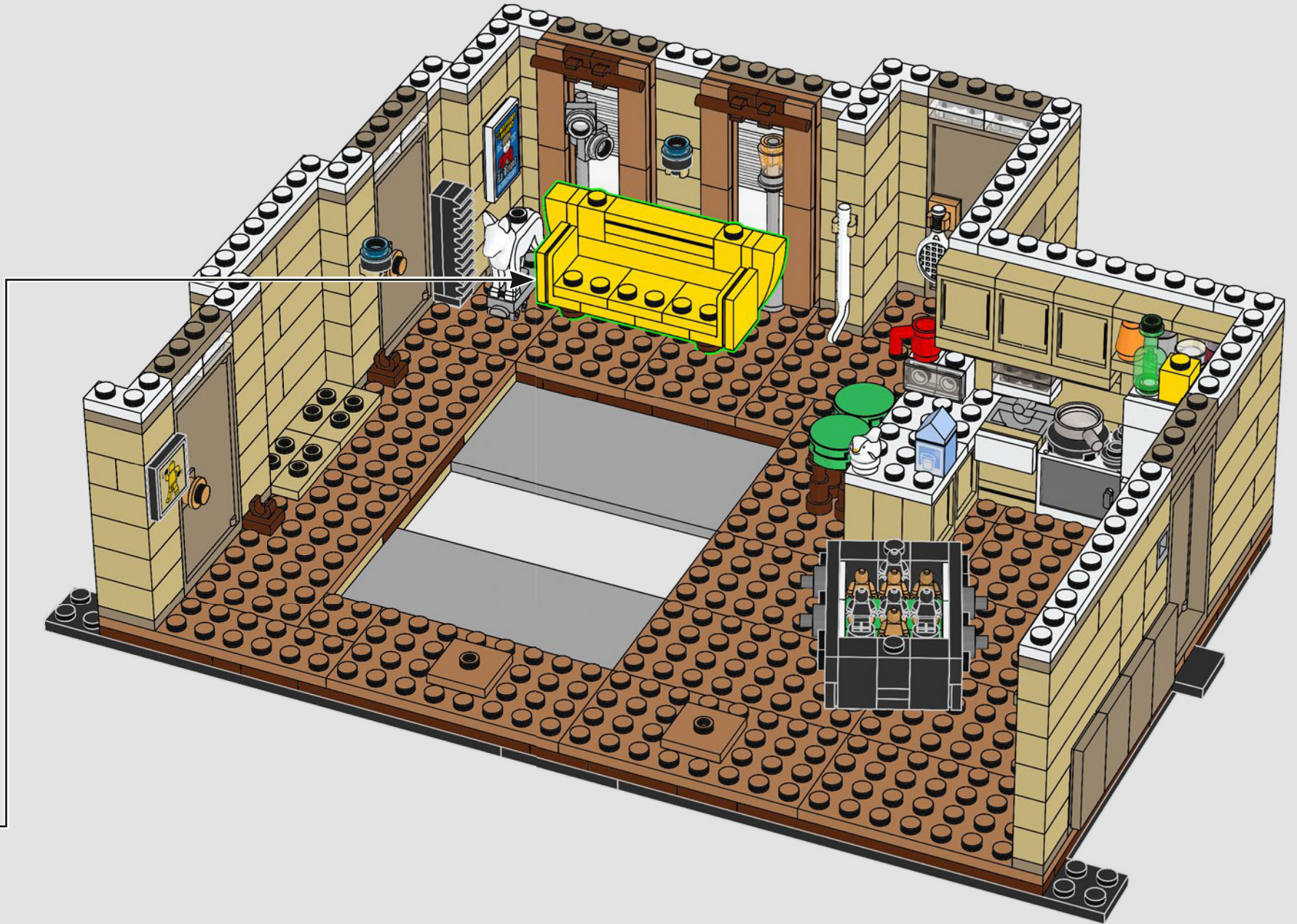

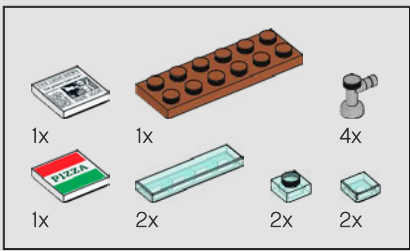

88

1

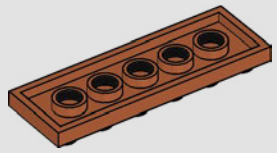

2

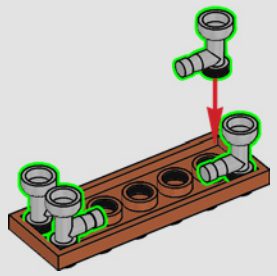

3

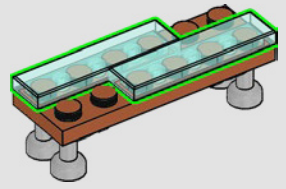

4

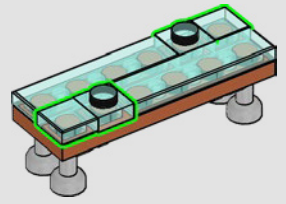

5

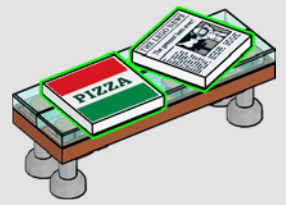

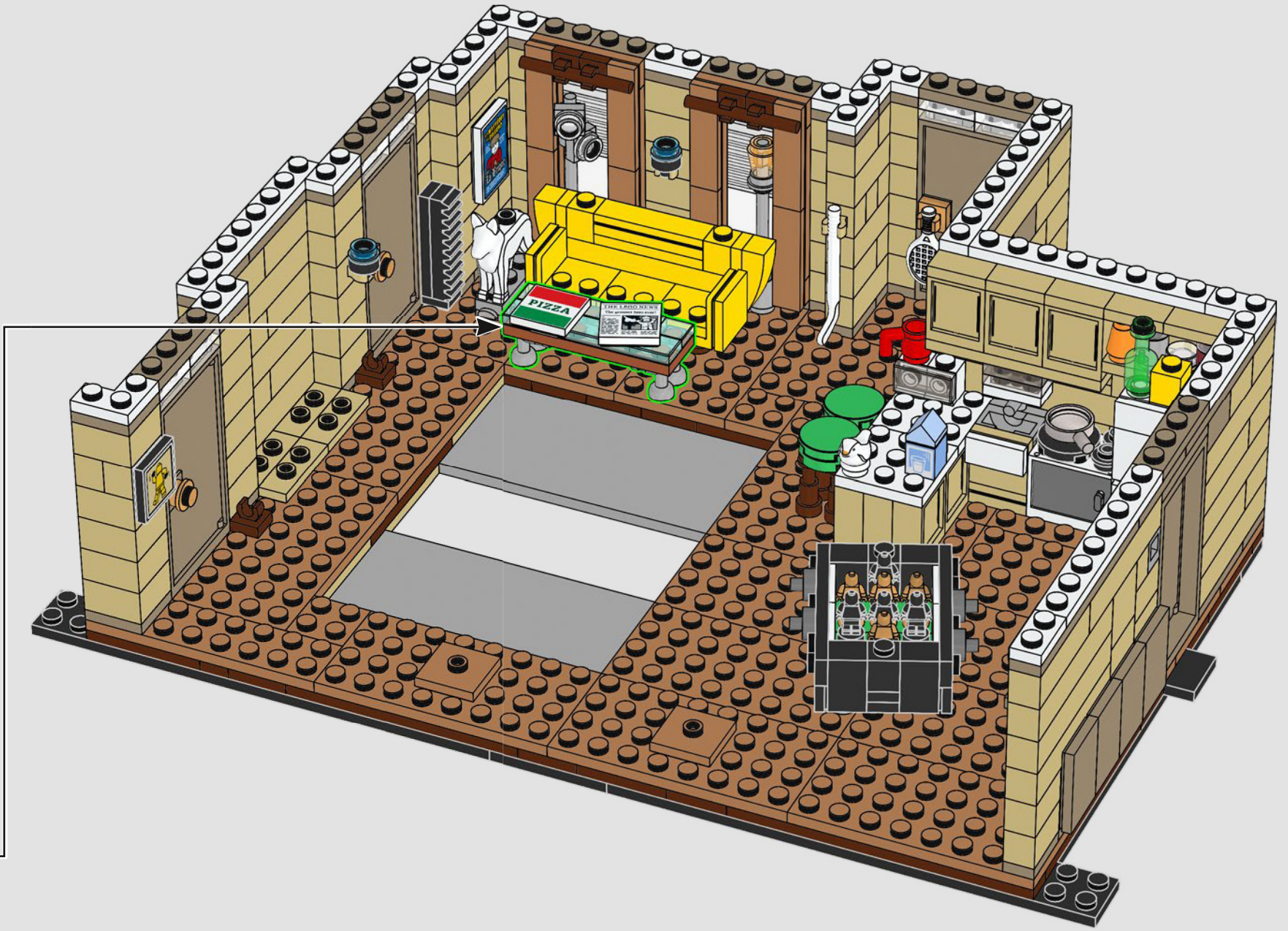

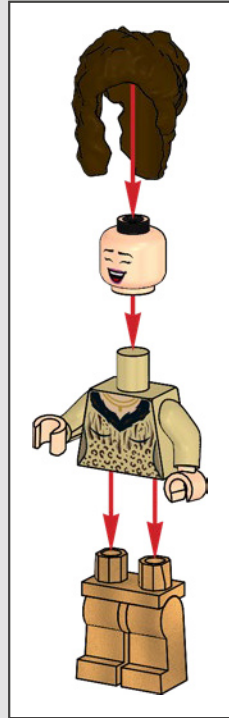
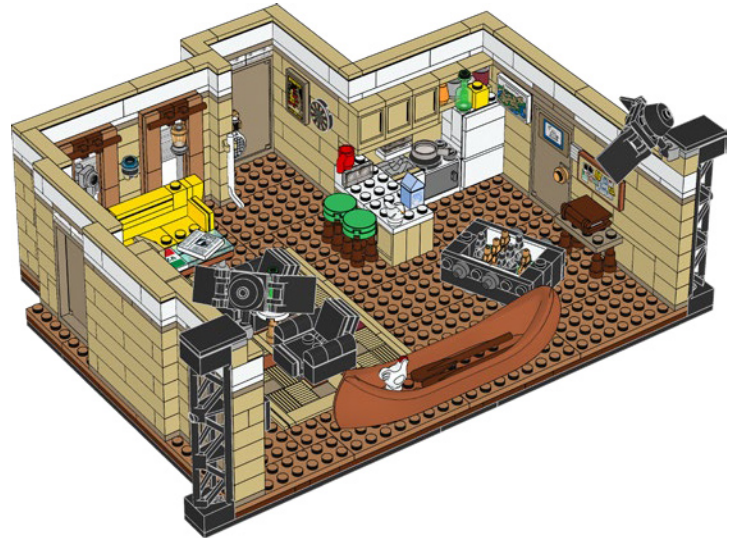
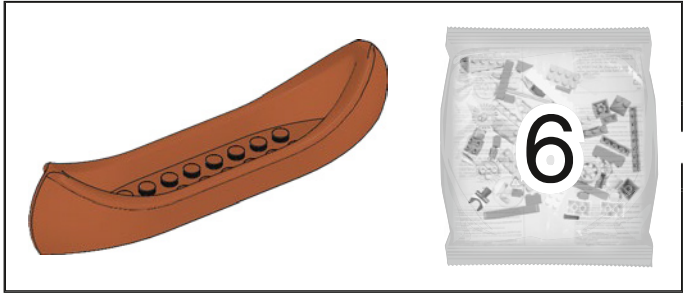

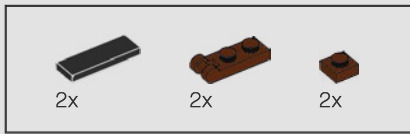

89

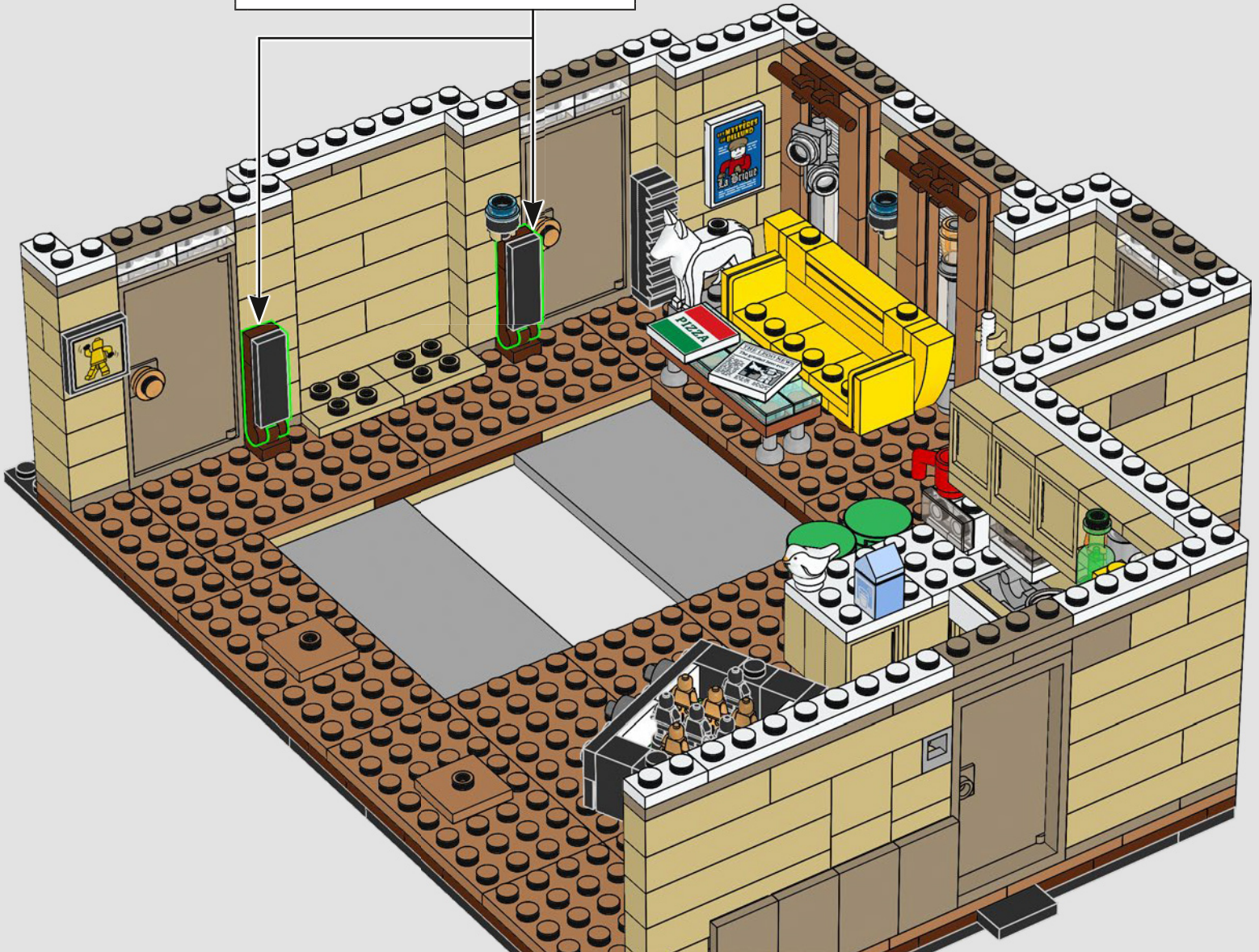
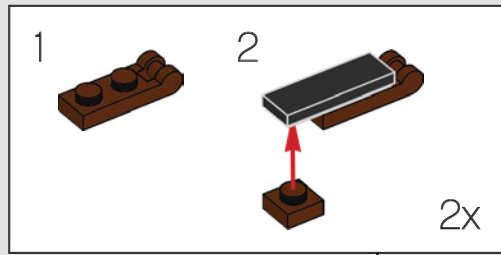

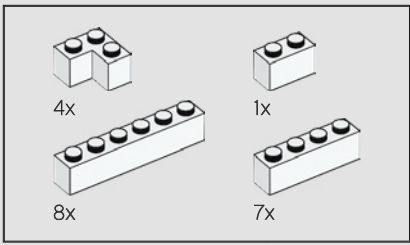

90

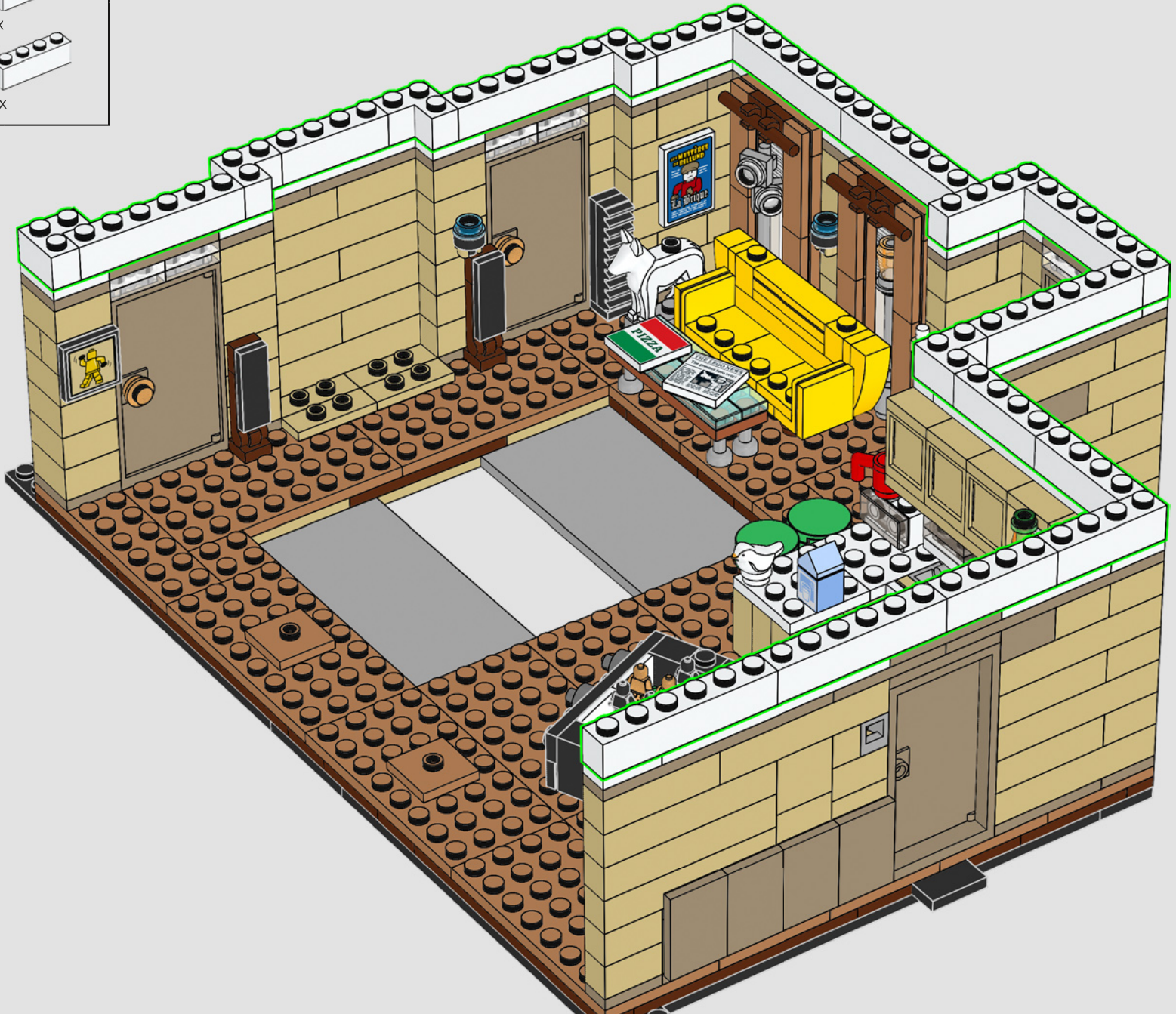

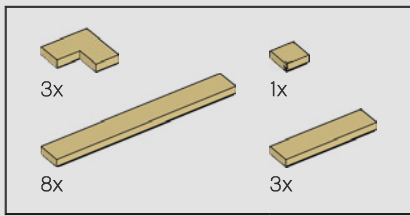

91



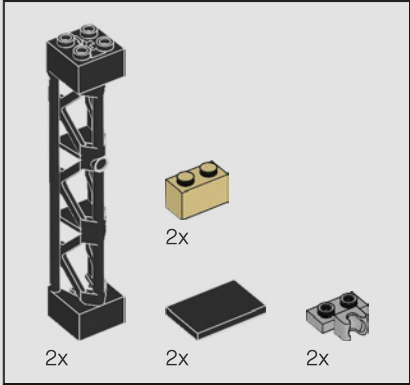
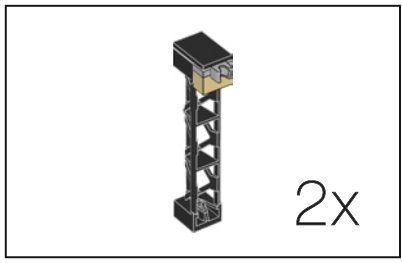

92

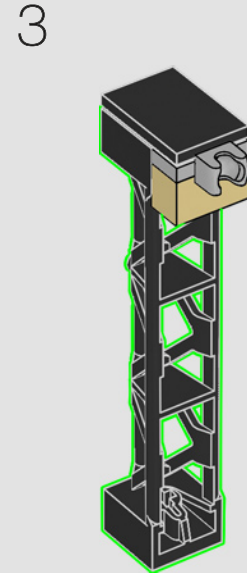
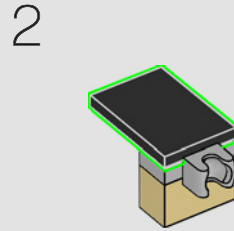
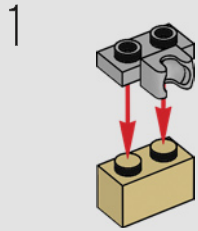



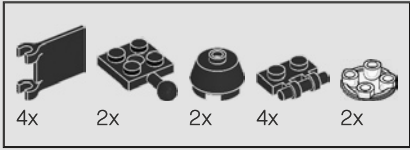
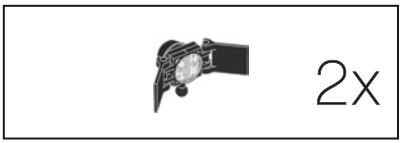

93

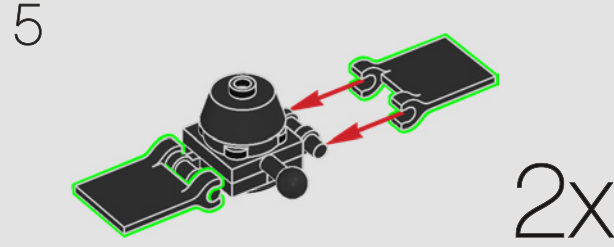
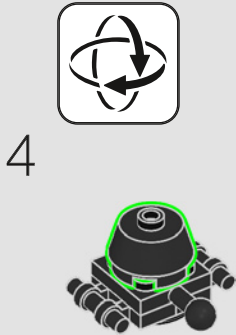
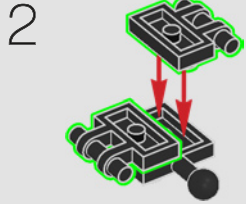

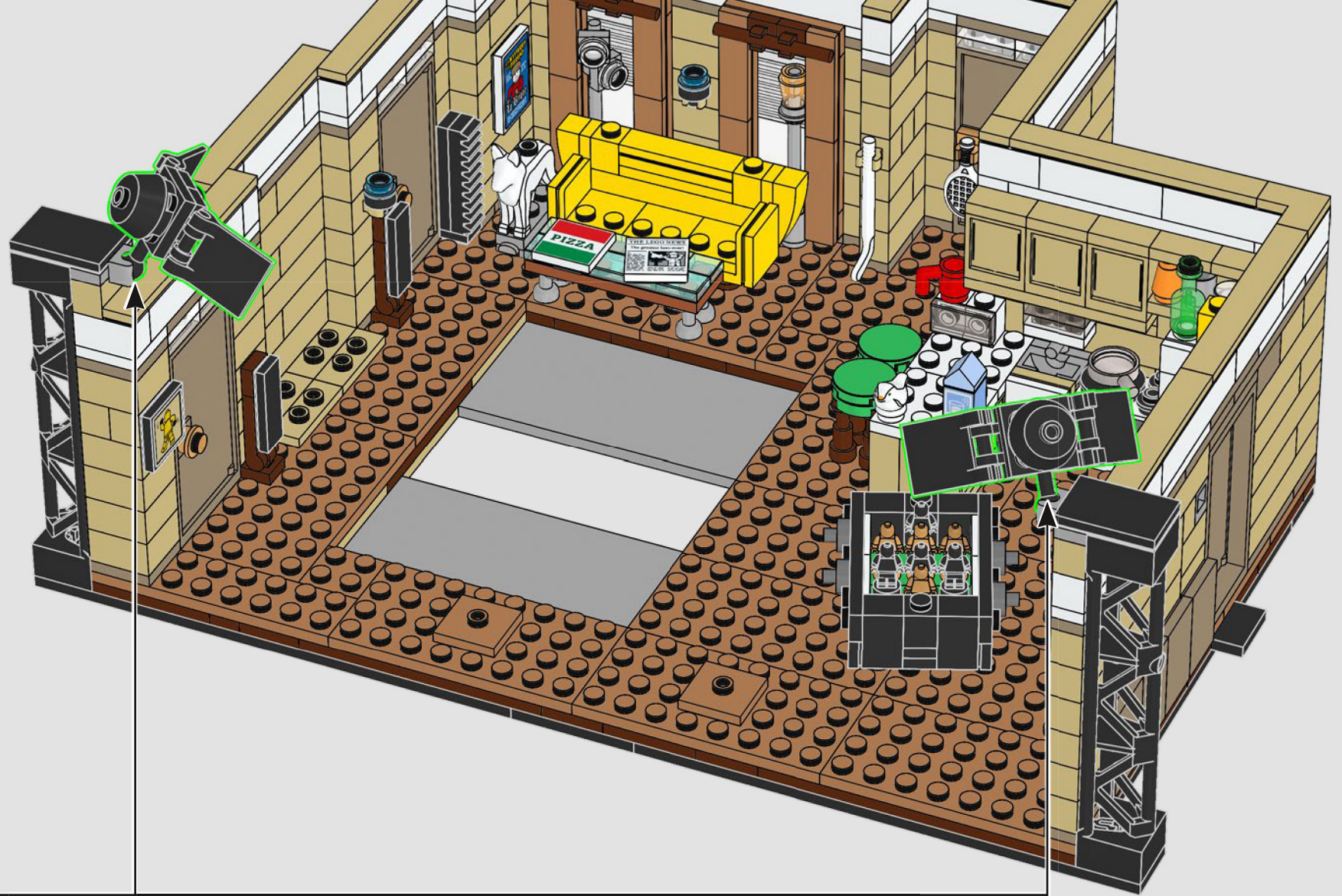

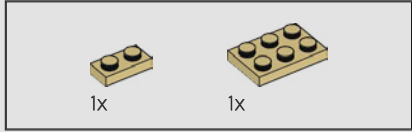
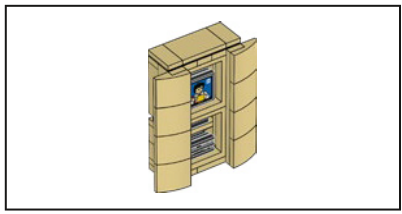

94

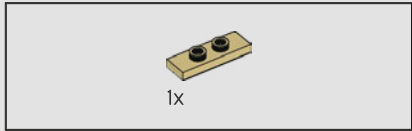
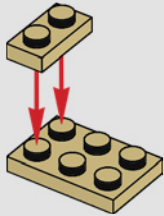

95

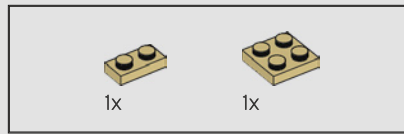
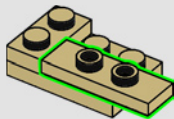

96

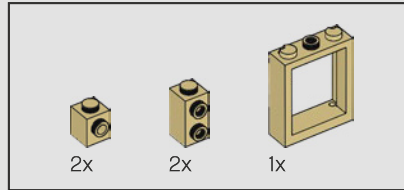
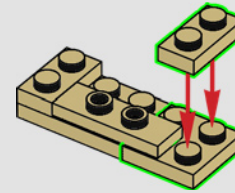

97

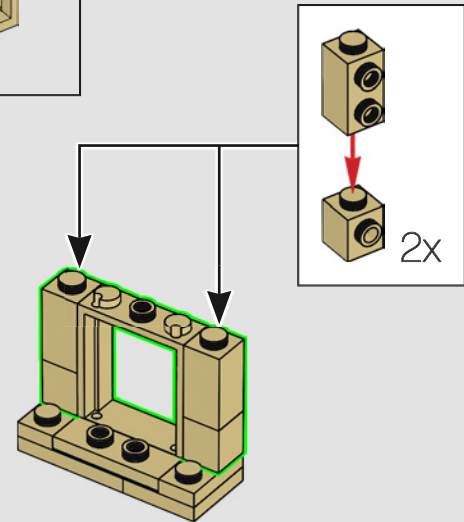

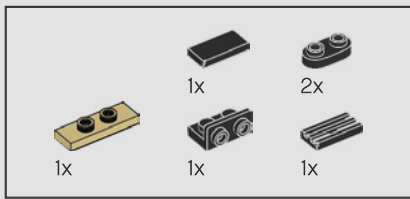

98

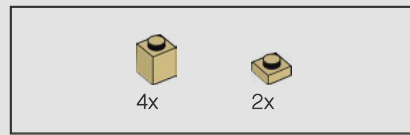
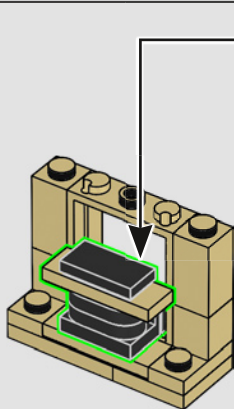
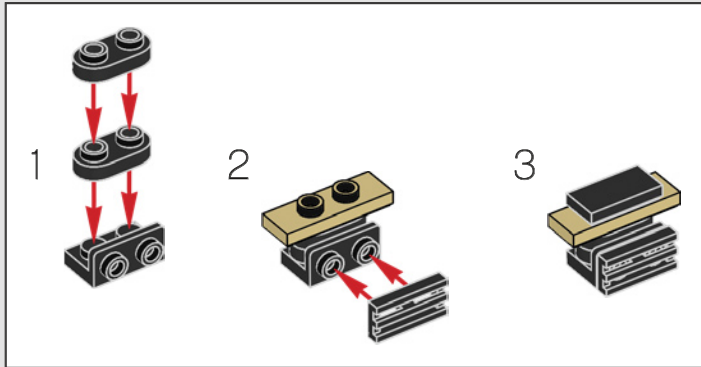

99

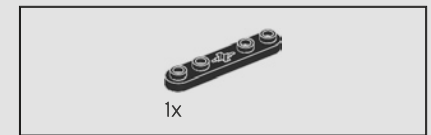
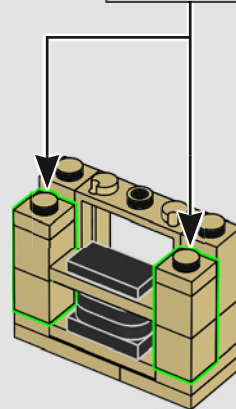
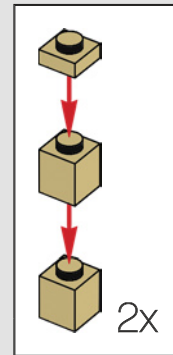

100

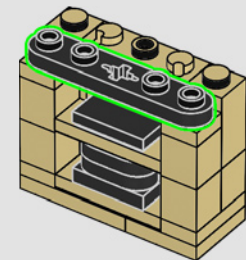

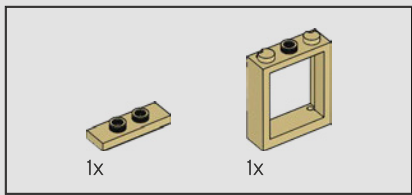

101

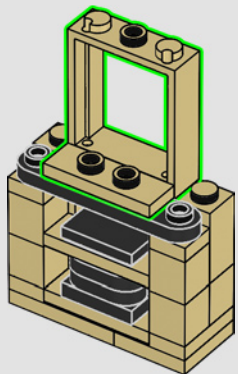

102

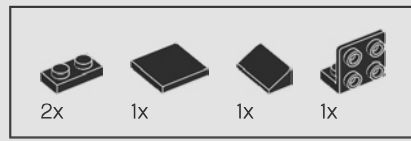
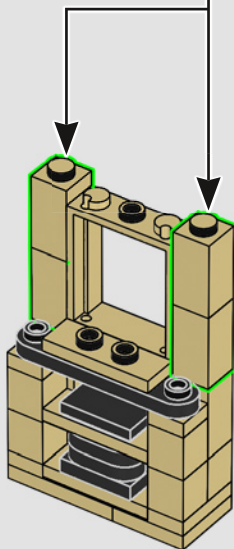
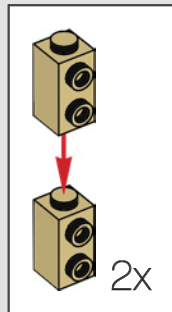

103

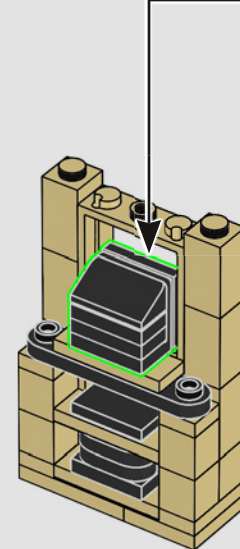
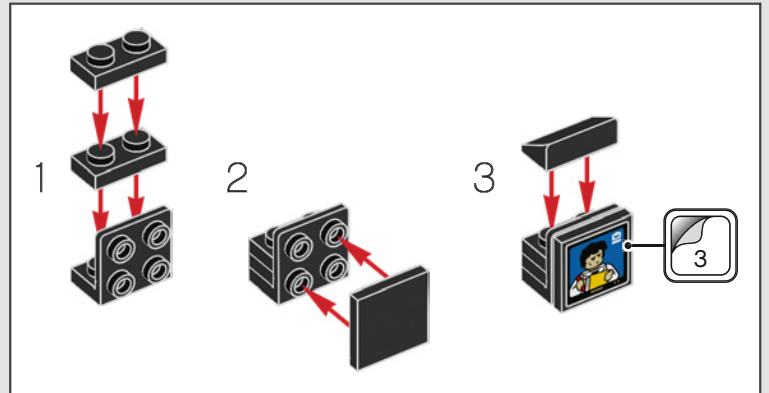

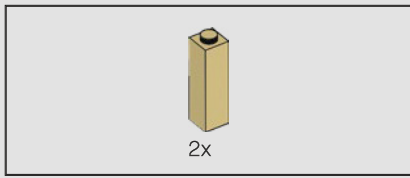

104

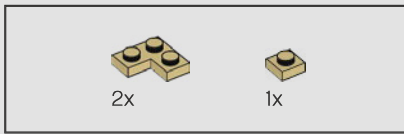
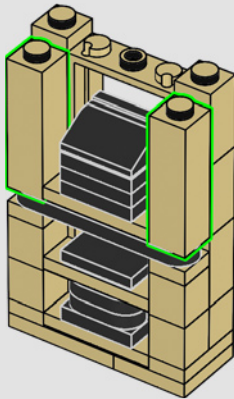

105

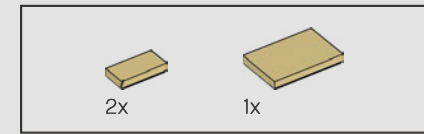
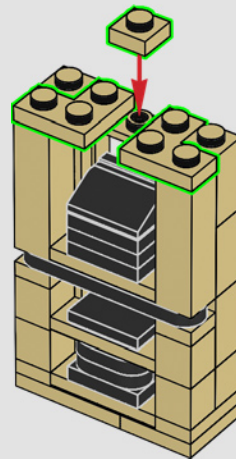

106

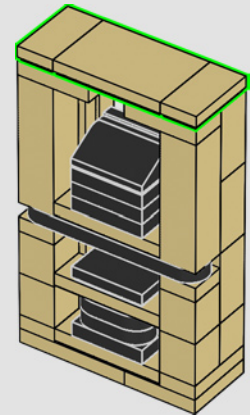

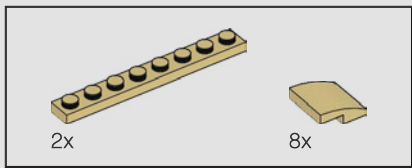

107

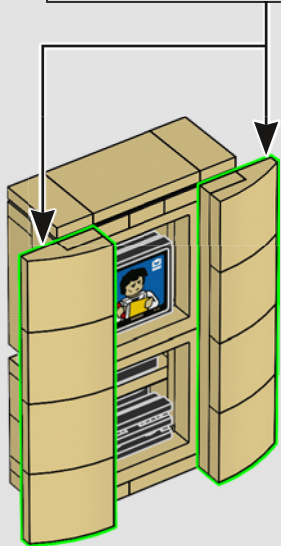
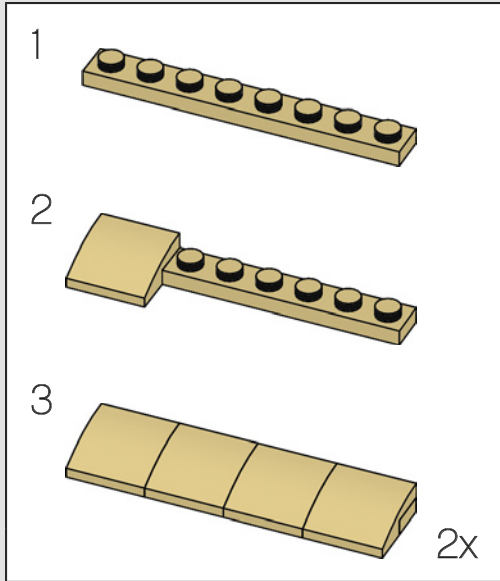

• The sticker of the TV screen shows Joey as Dr. Drake Ramoray, his first major and most famous role on a soap opera TV series.

• L'autocollant de l'écran de télévision montre Joey incarnant le Dr Drake Ramoray, son premier grand rôle, ainsi que son plus célèbre, dans un feuilleton.

• La calcomanía de la pantalla del televisor representa a Joey en el papel del Dr. Drake Ramoray, su primera y más famosa actuación importante en televisión.



108



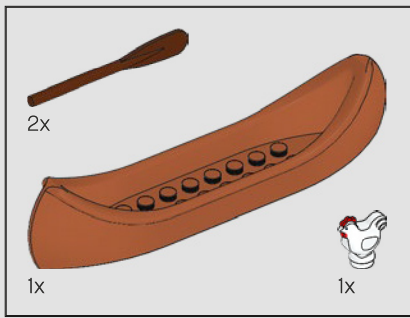

109

🔴 The wooden canoe the guys get stuck with after their apartment is robbed of all their furniture.

💙 Le canot en bois que les gars ont été contraints de prendre après que tous les meubles de leur appartement aient été volés.

🟡 Hay una canoa de madera por la que Joey y Chandler se vieron forzados a adquirir después de que todos los muebles de su departamento fueran robados.



1

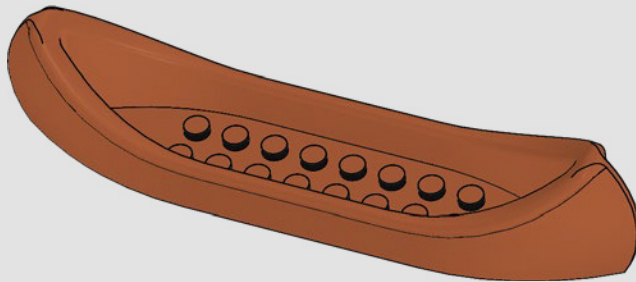

2

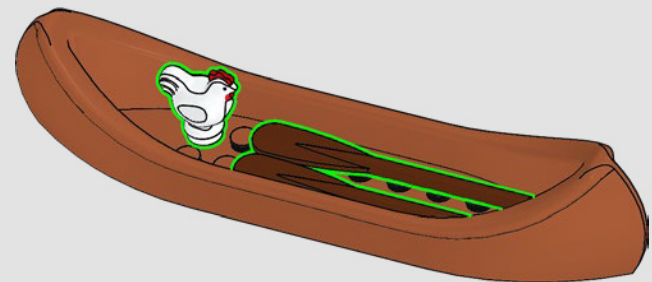

● The duck and chicken that Chandler and Joey adopt and raise over time.

● Le canard et la poule que Chandler et Joey adoptent et élèvent au fil du temps.

● El pato y el pollo están allí por los que Chandler y Joey adoptan y crían por mucho tiempo.

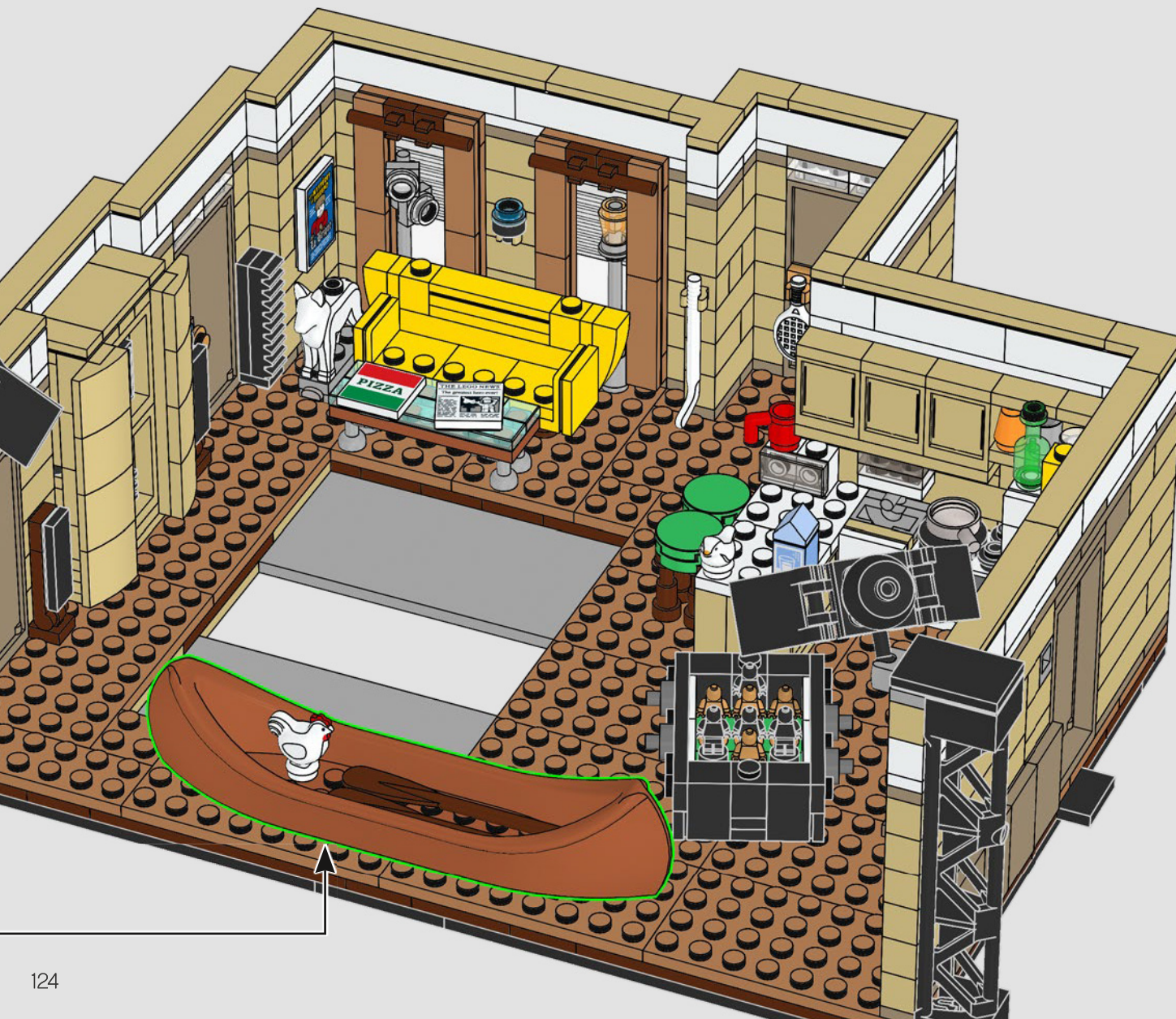

110

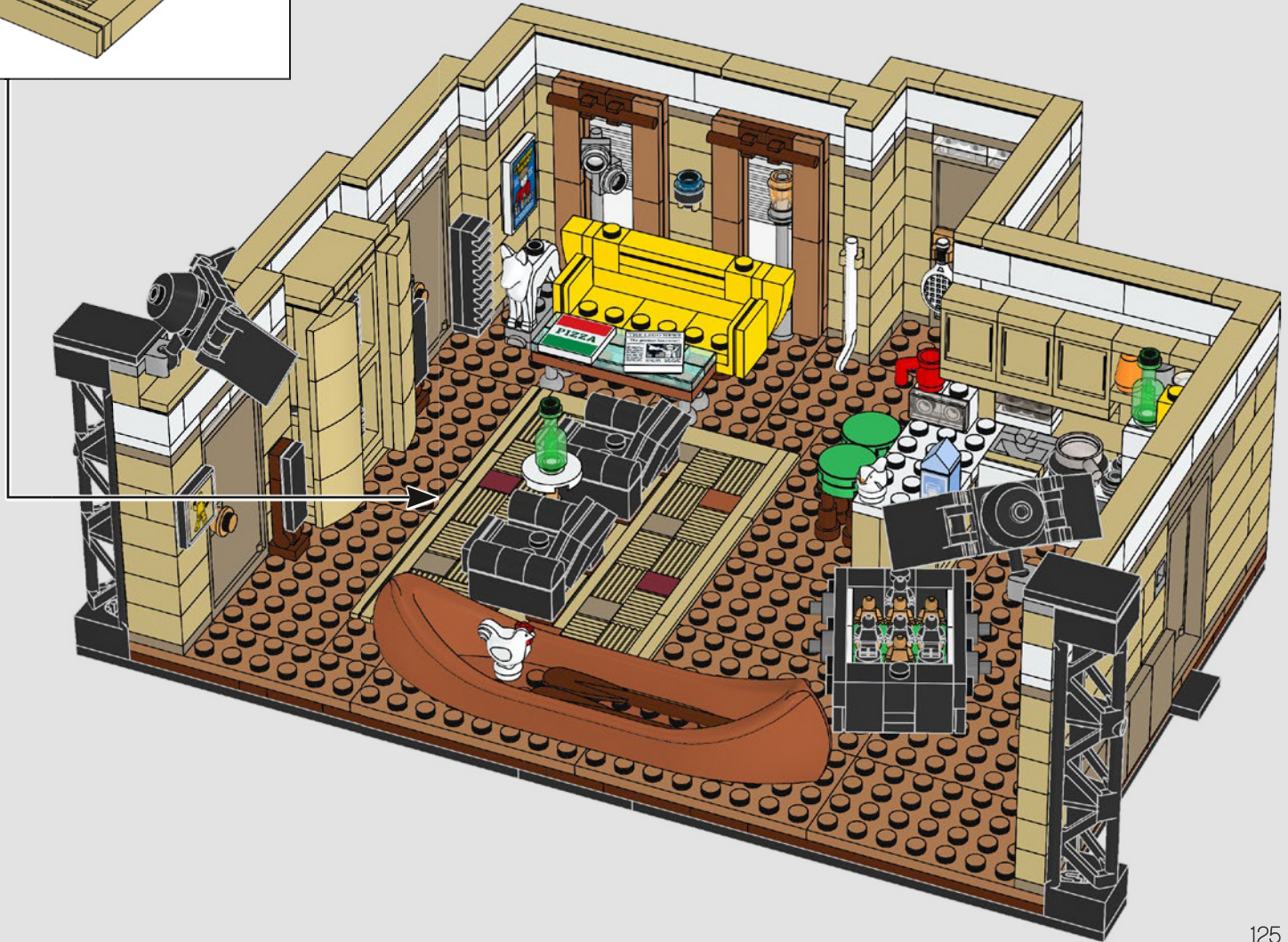
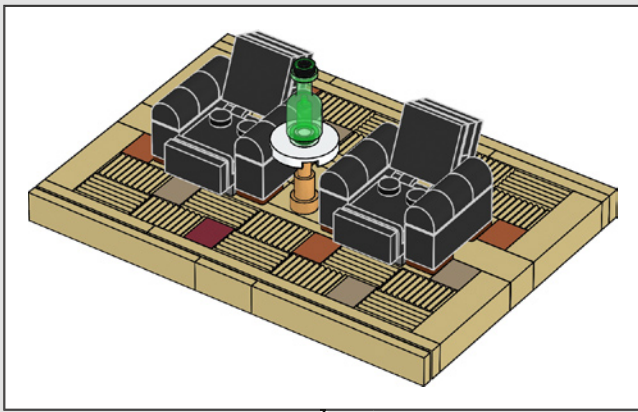

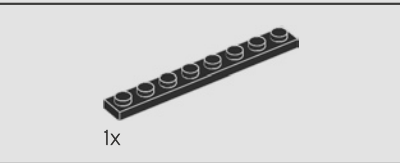
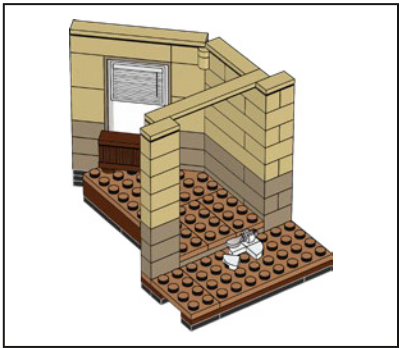
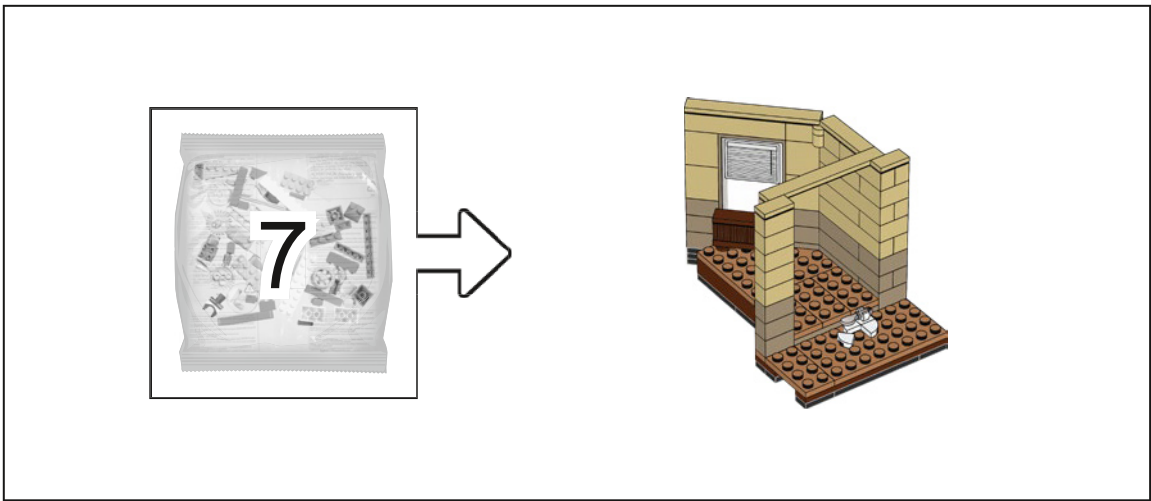

1

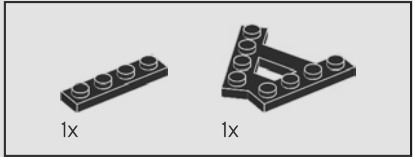
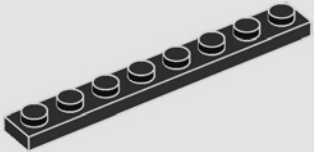

2

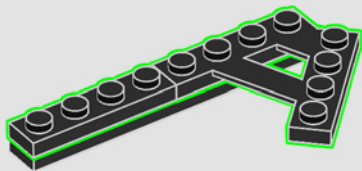

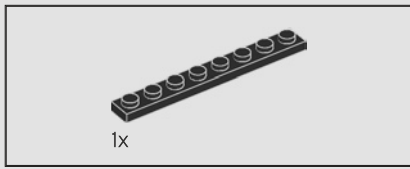

3

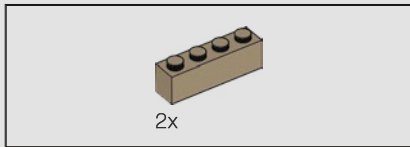
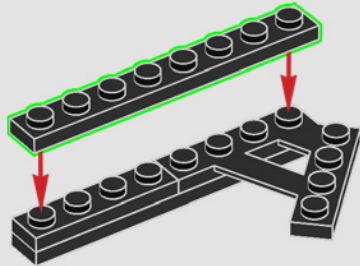

4

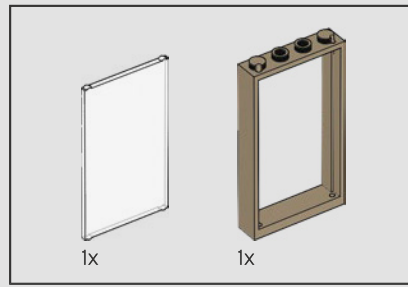
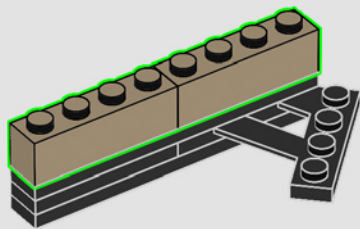

5

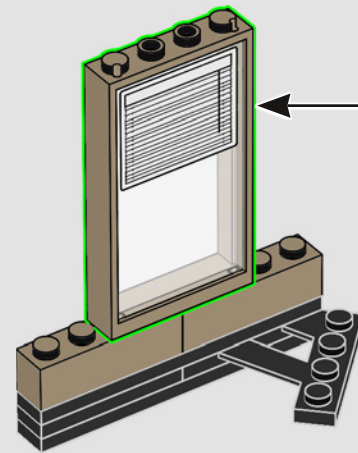
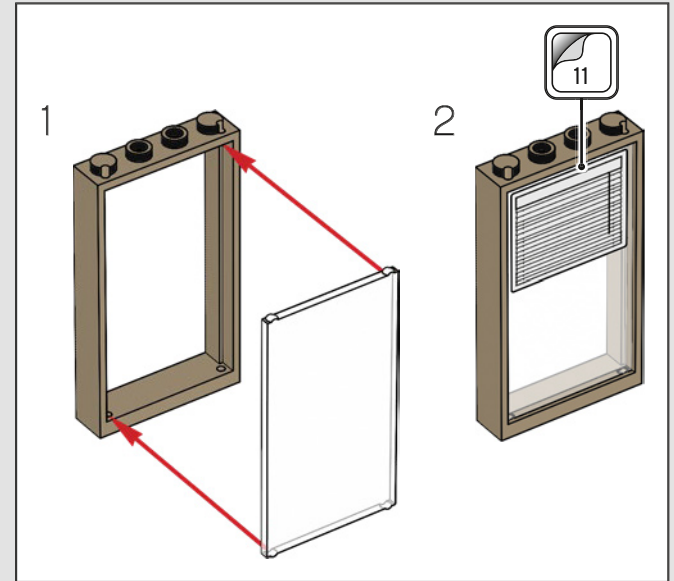

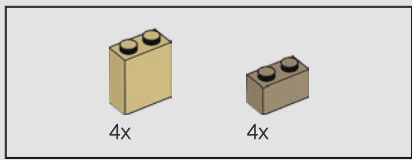

6

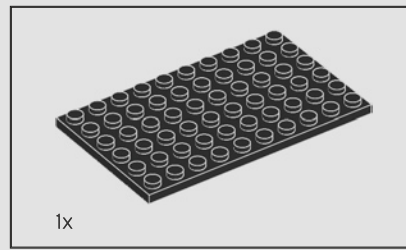
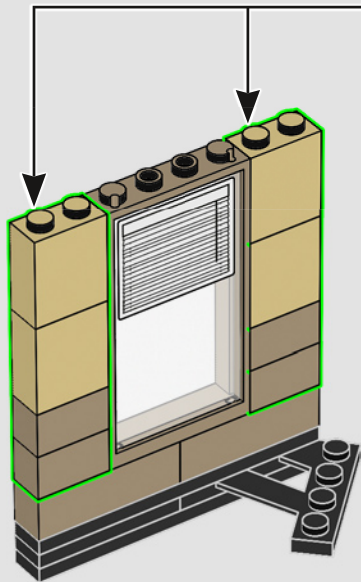
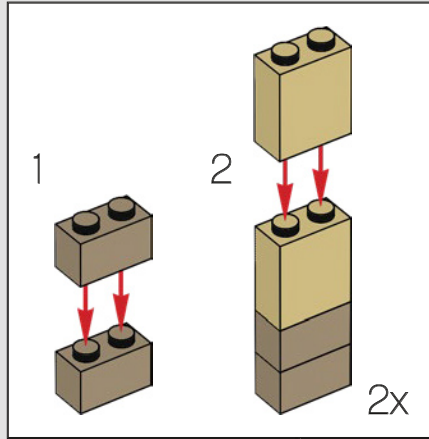

7

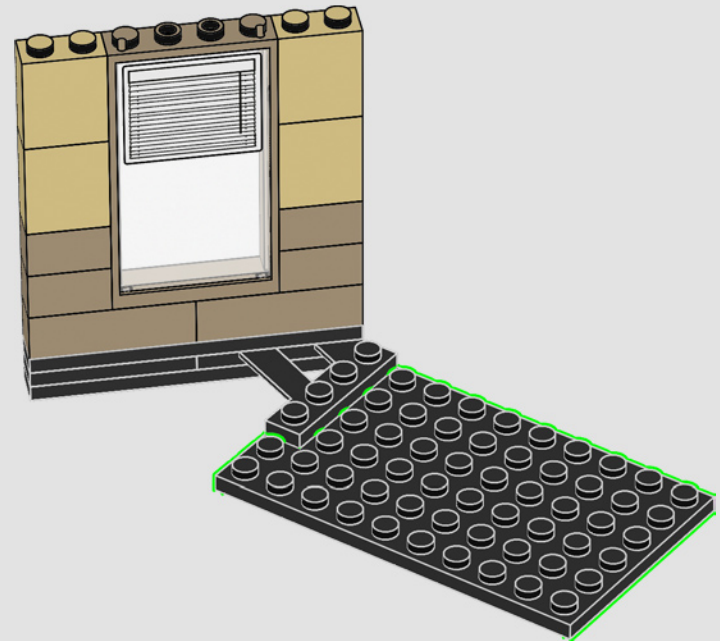

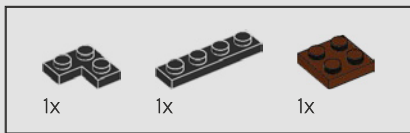

8

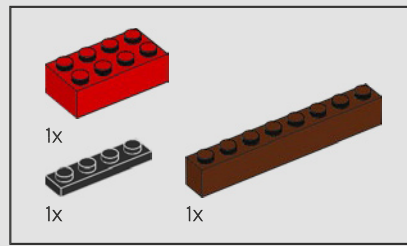
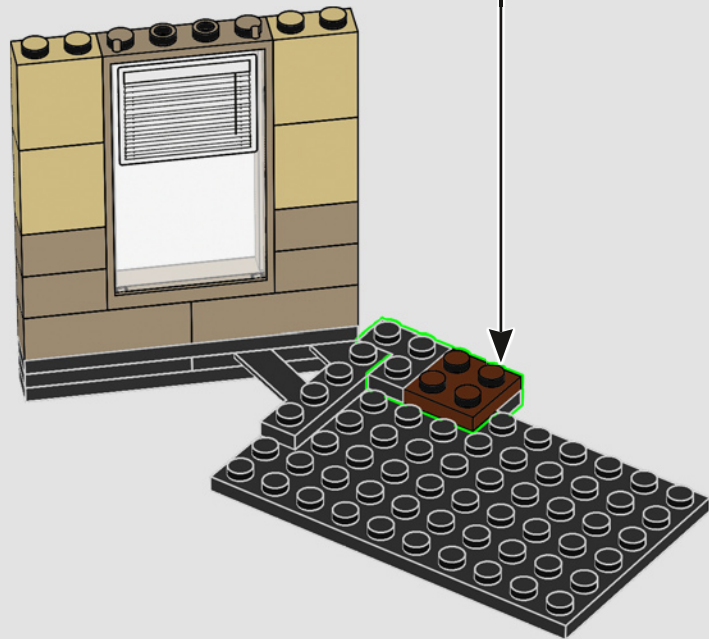
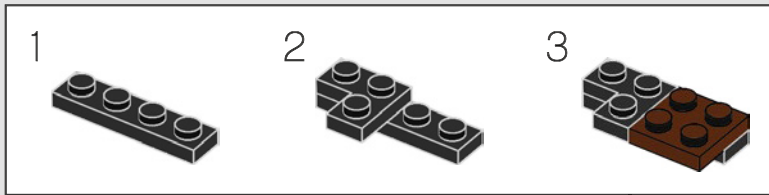

9

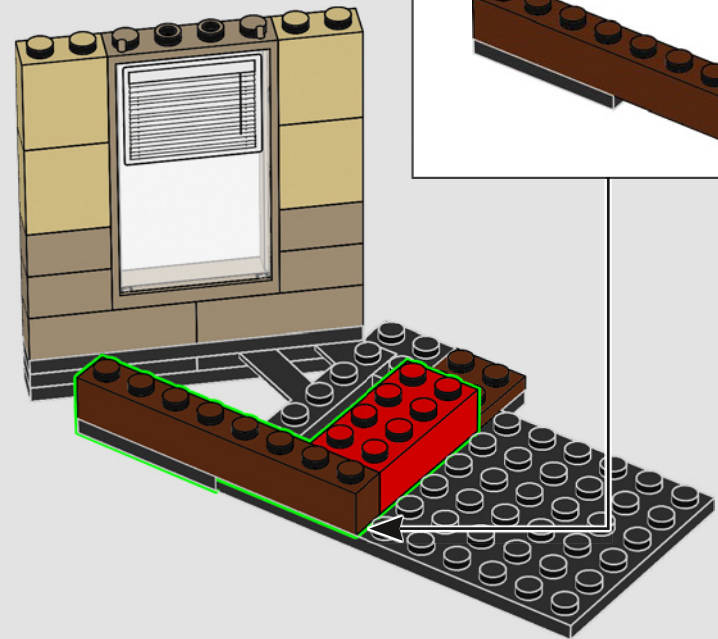
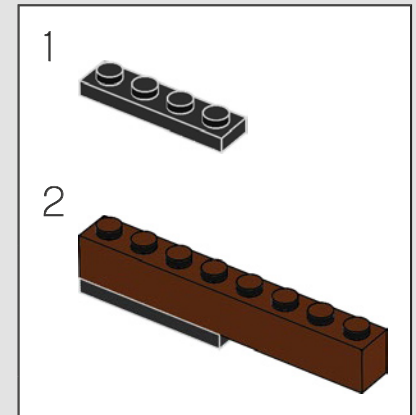

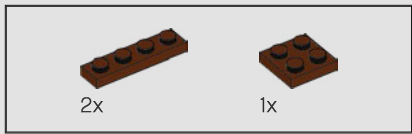

10

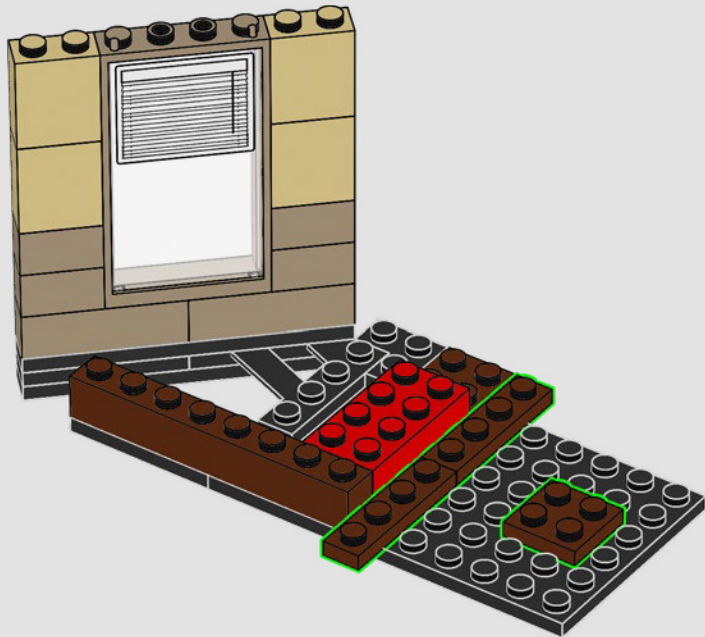

11

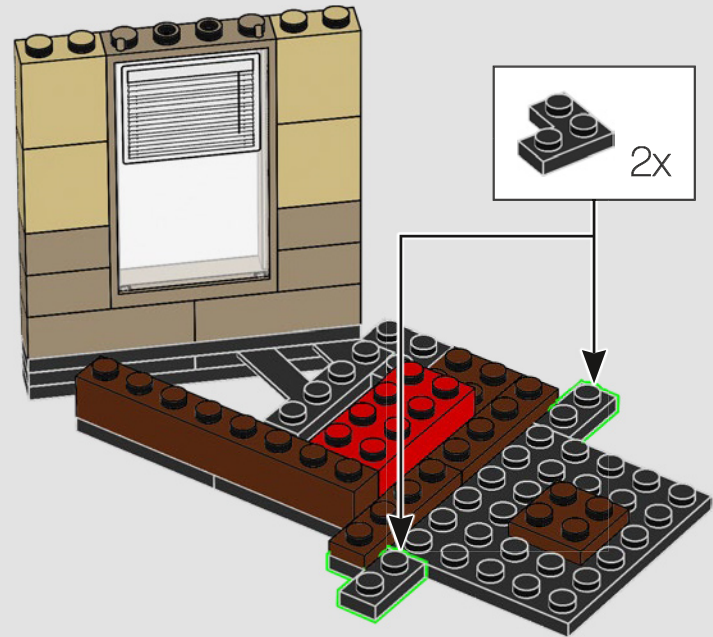

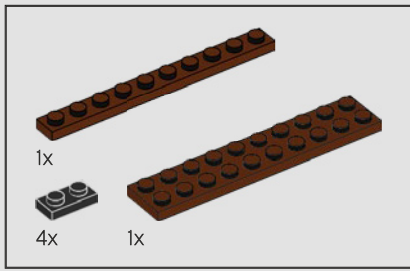

12

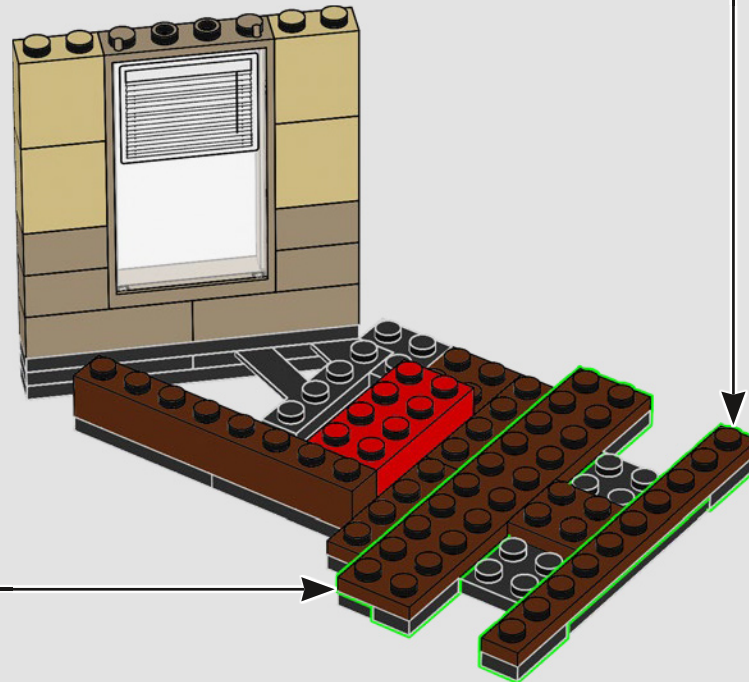
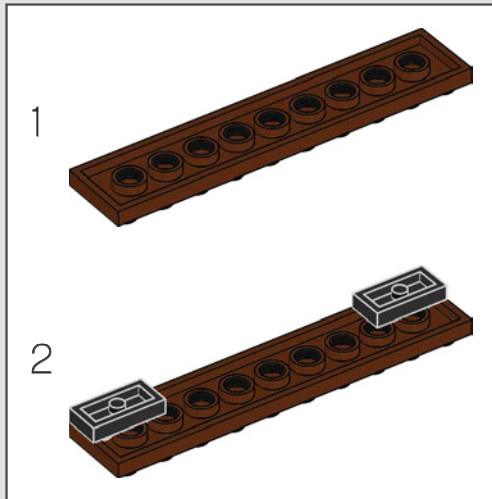
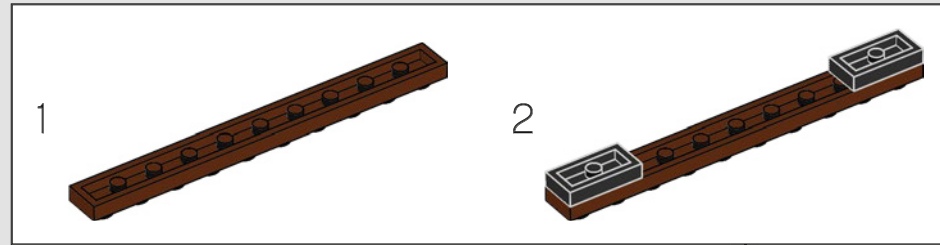

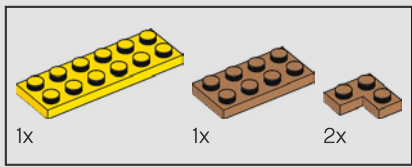

13

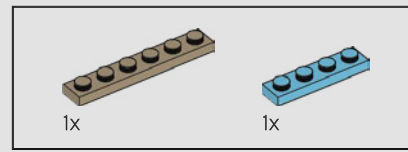

14

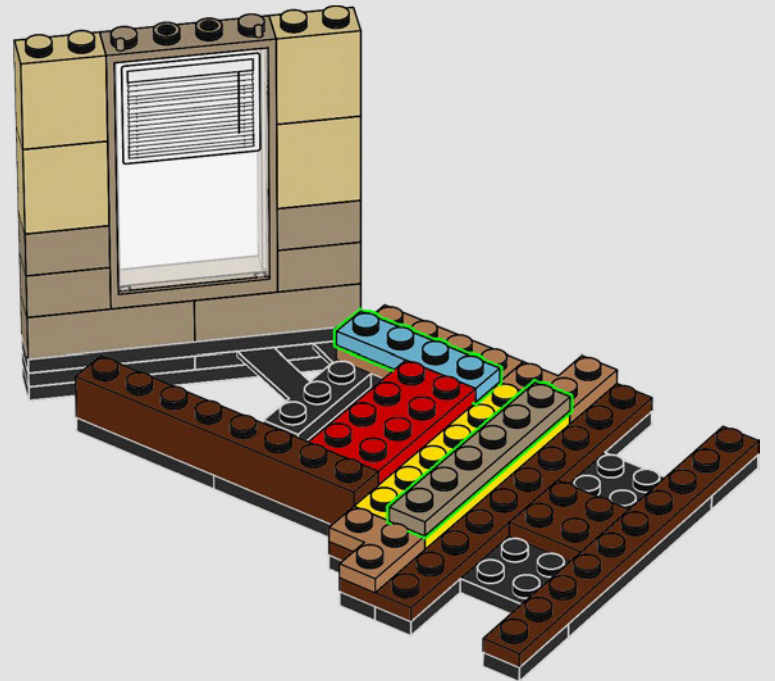

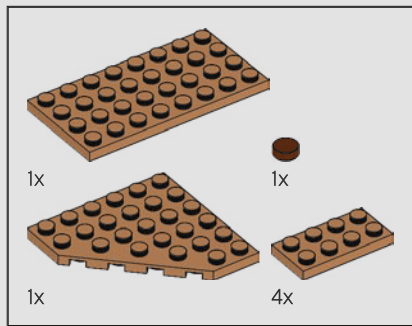

15

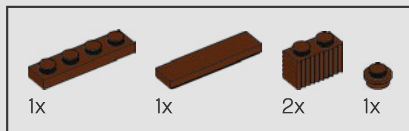
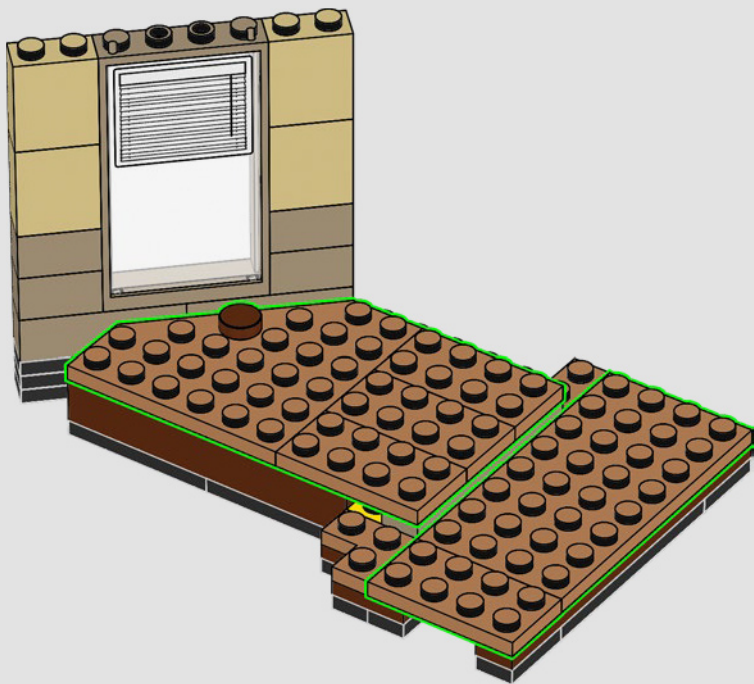

16

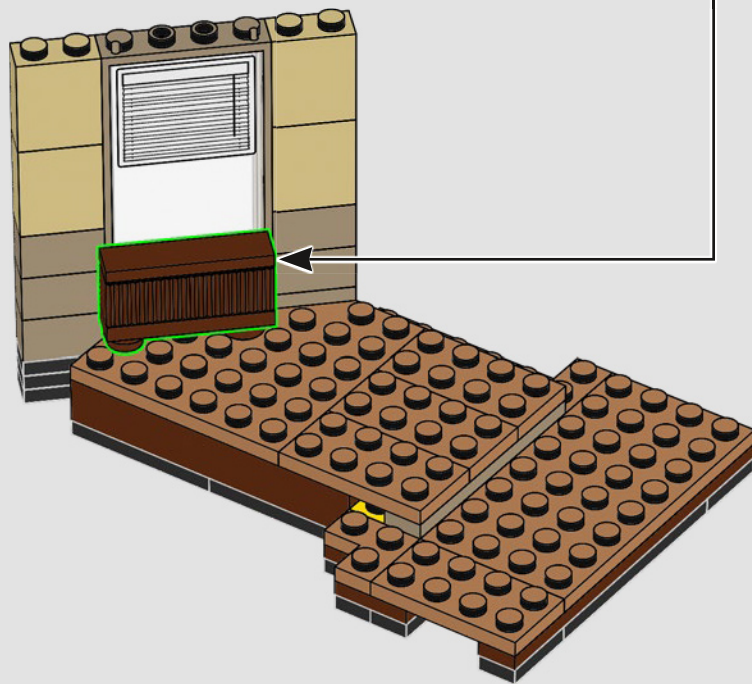
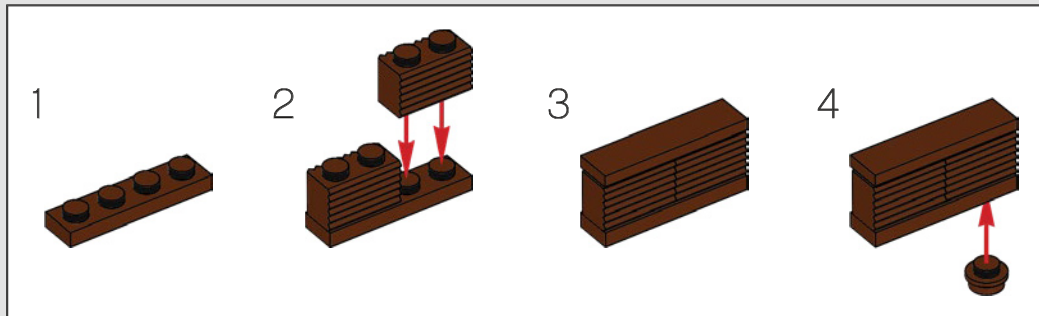

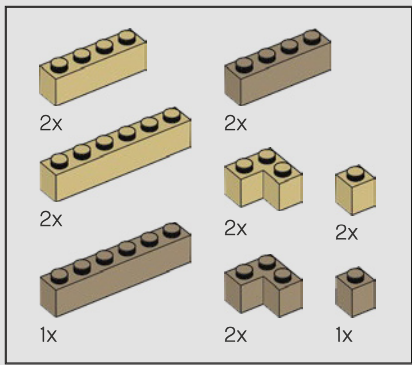

17

1

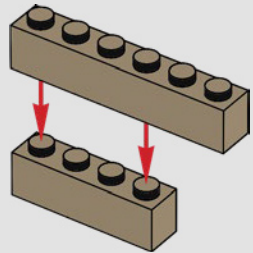

2

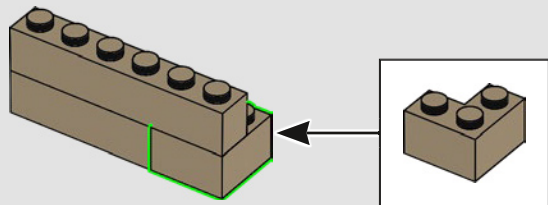

3

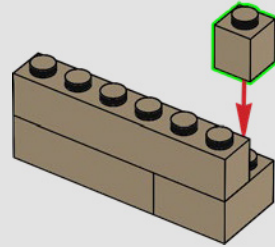

4

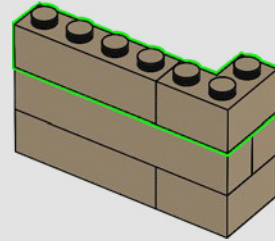

5

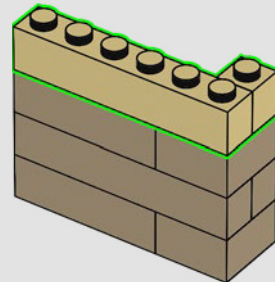

6

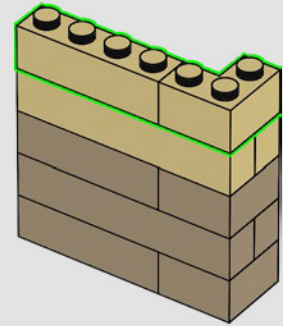

7

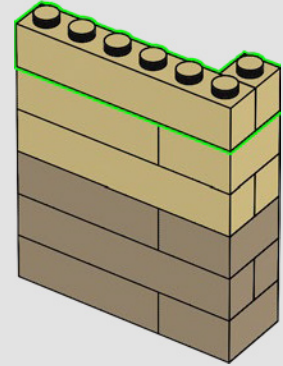

8

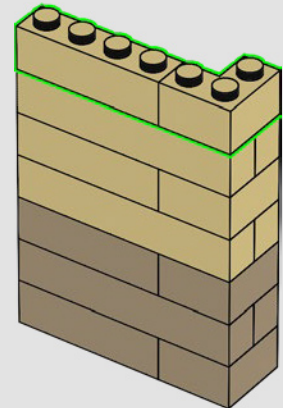

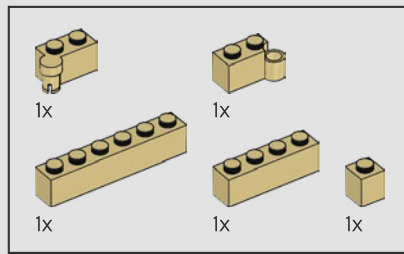

18

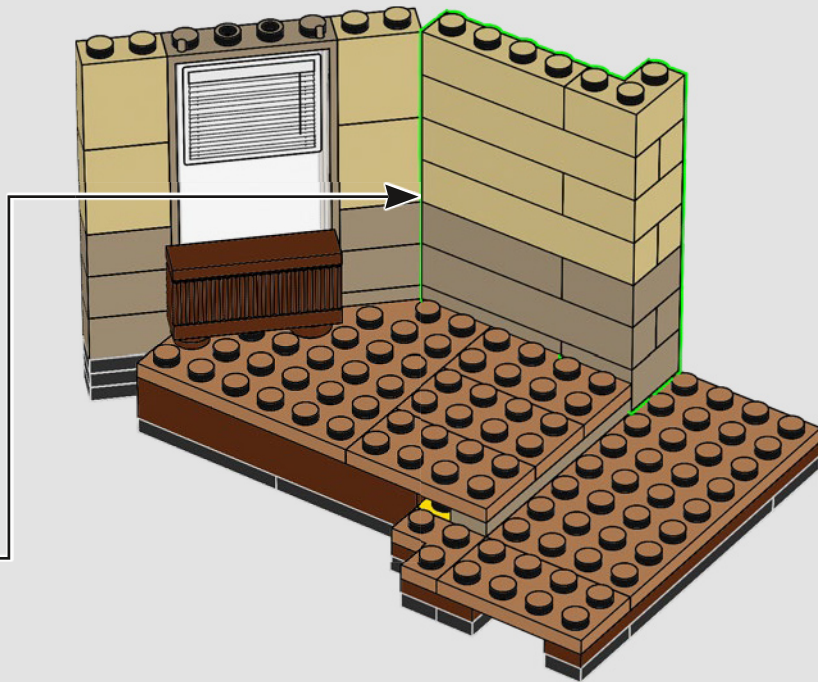
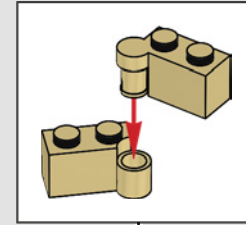

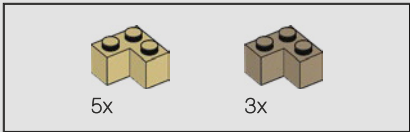

19

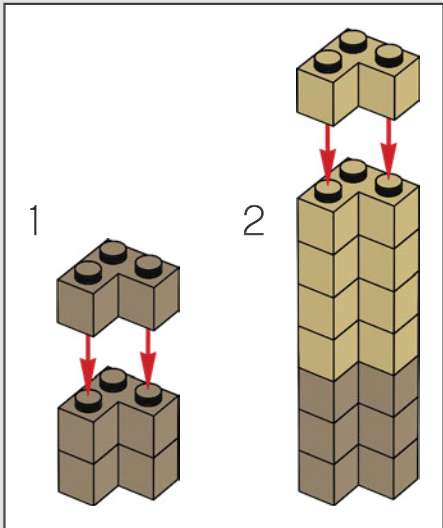

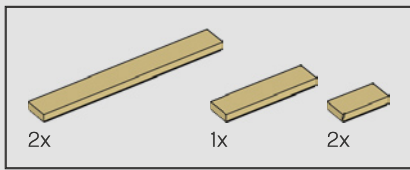

20

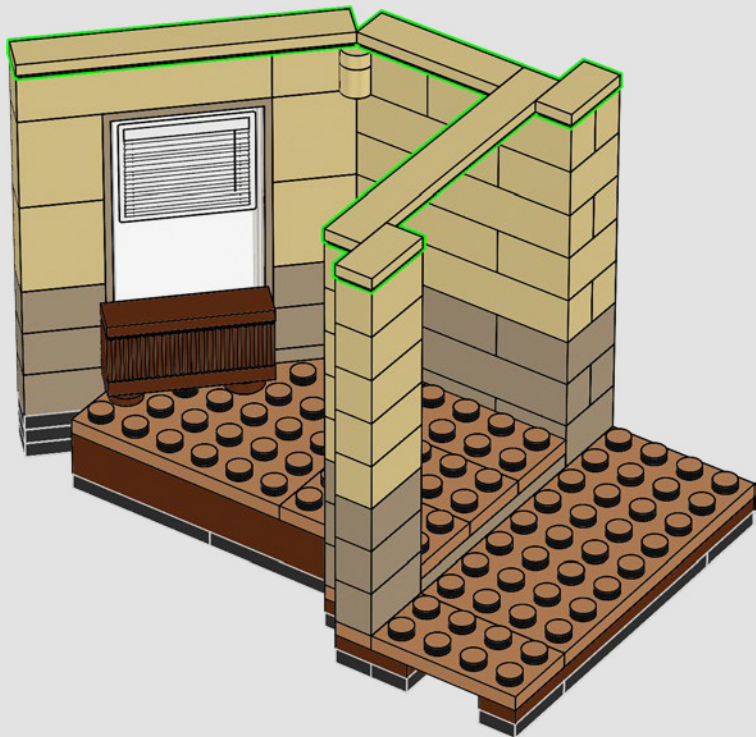

21

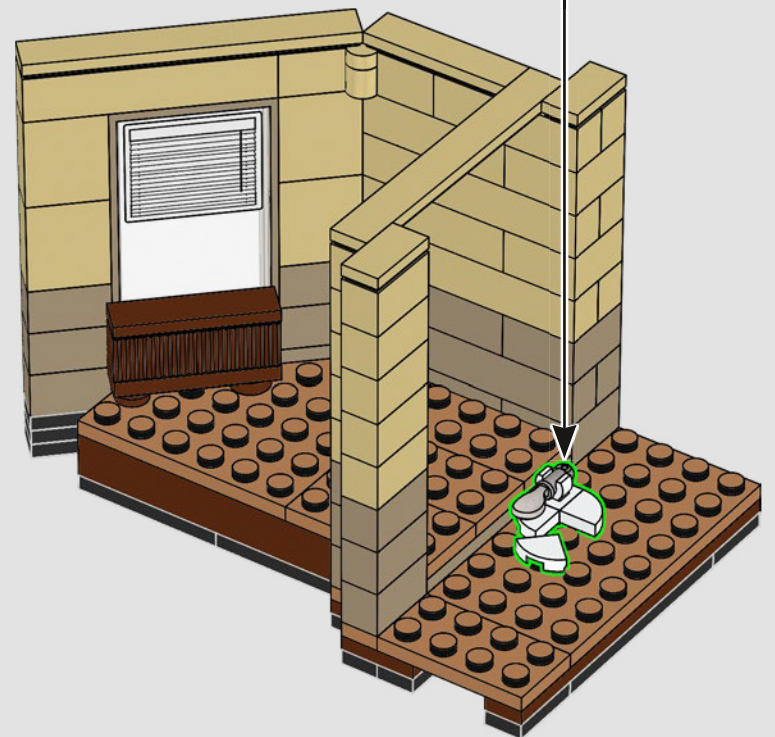
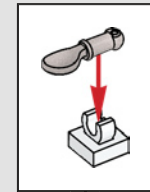

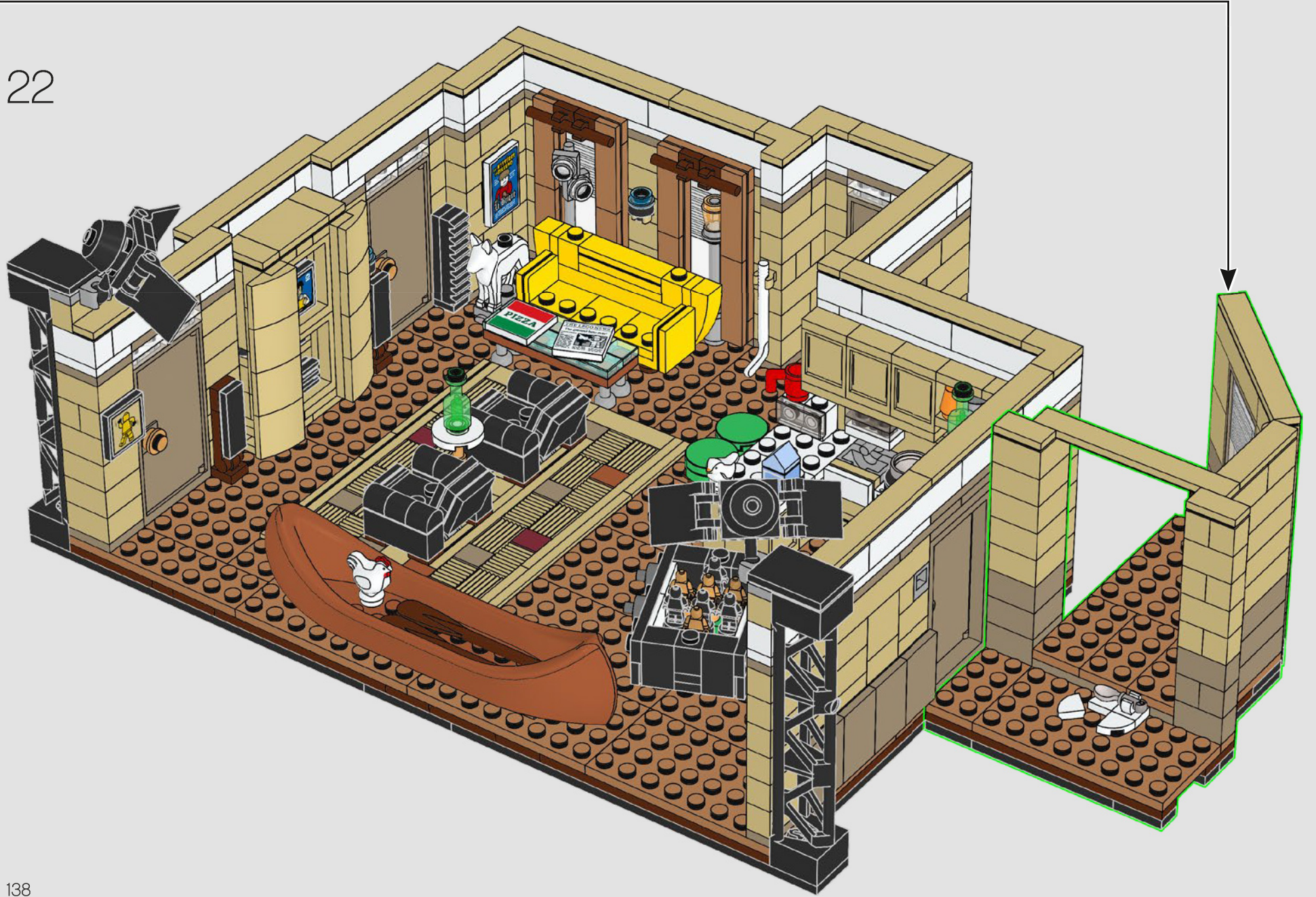

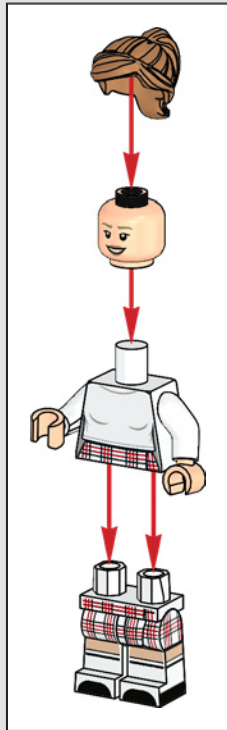
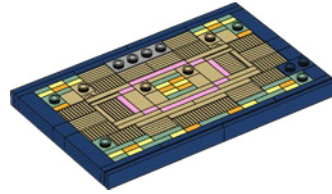

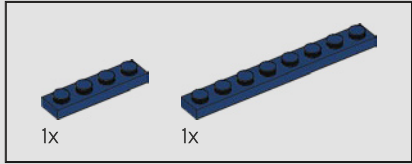
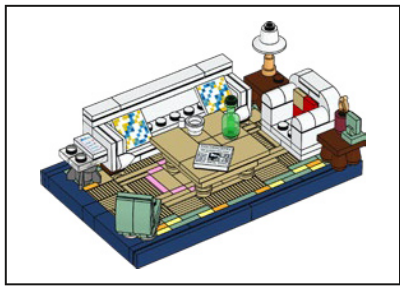

1

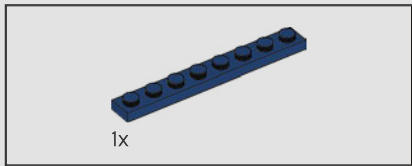
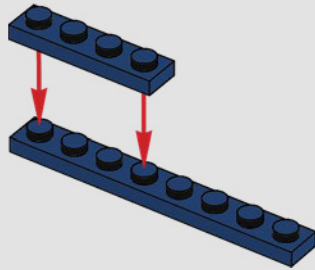

2

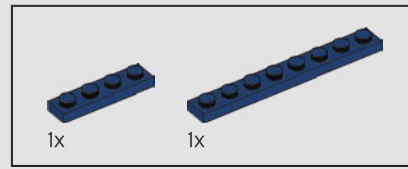
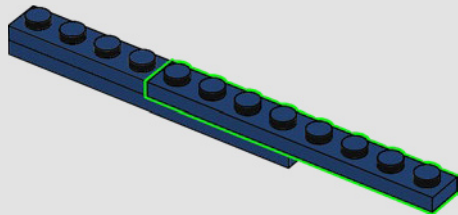

3

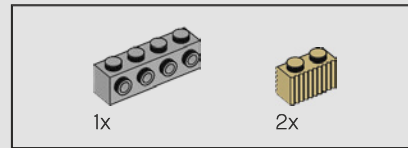
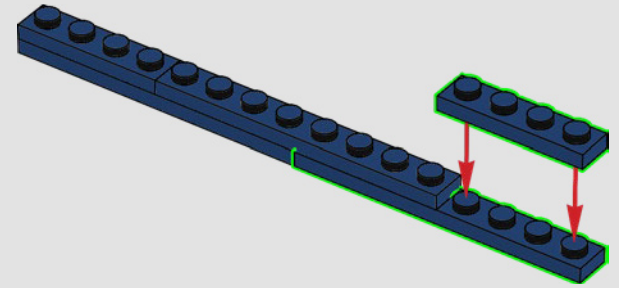

4

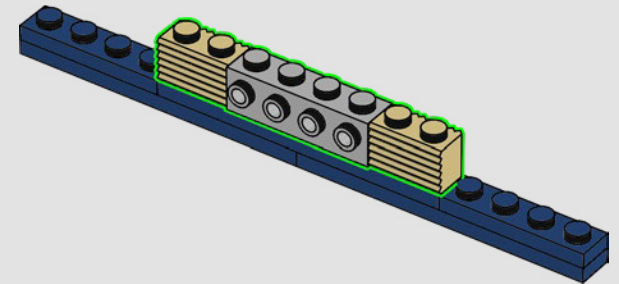

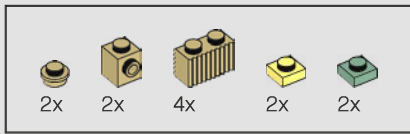

5

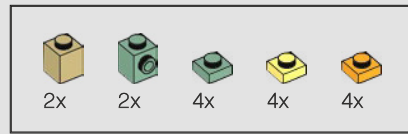
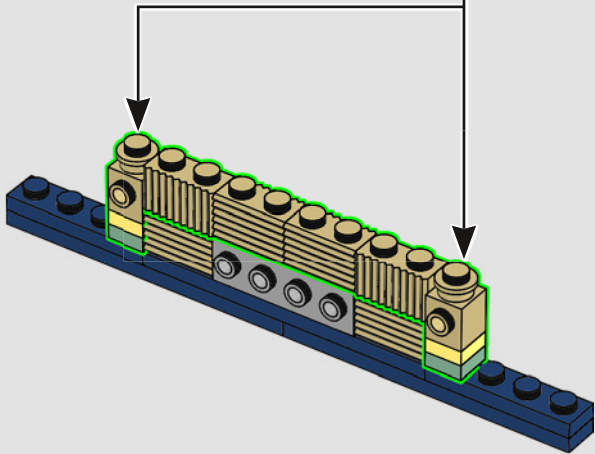
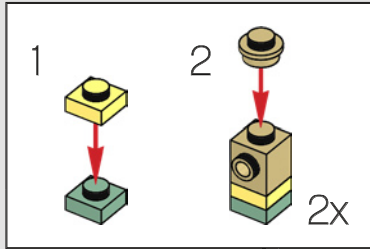

6

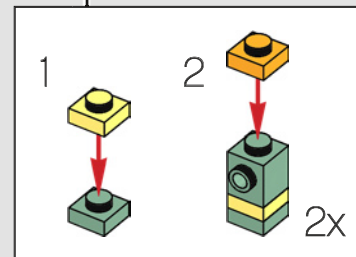
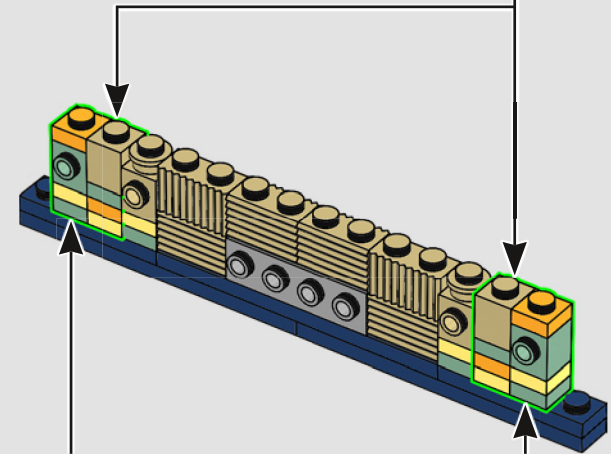
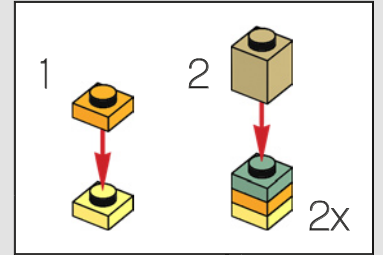

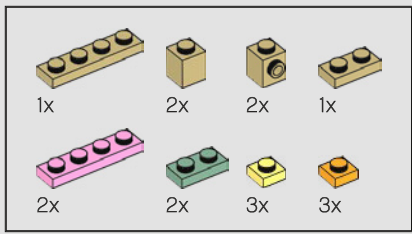

7

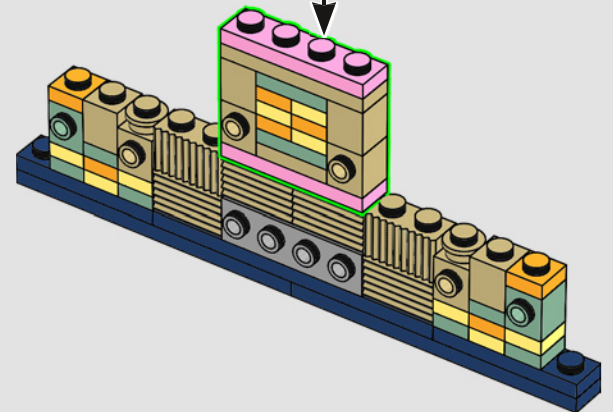
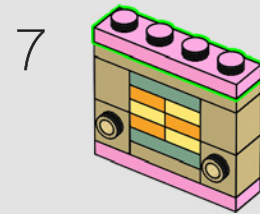
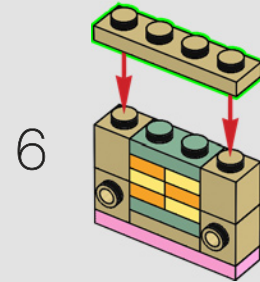
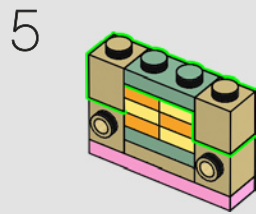
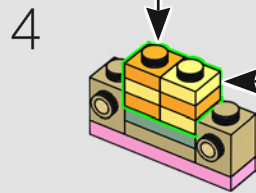
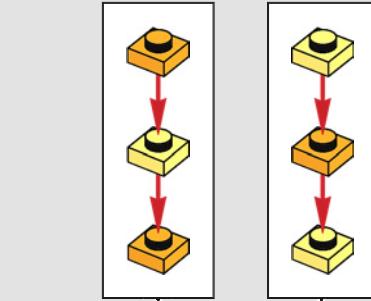
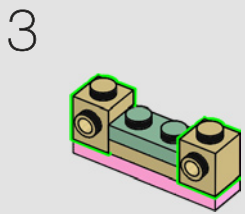
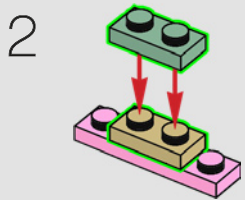
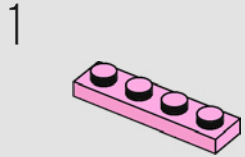

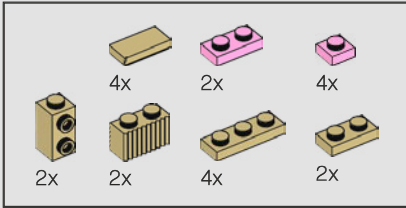
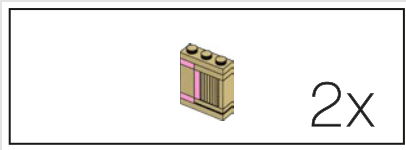

8

1

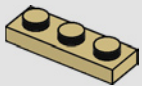

2

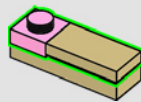

3

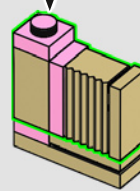

4

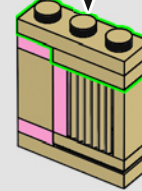

2x

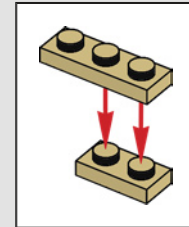
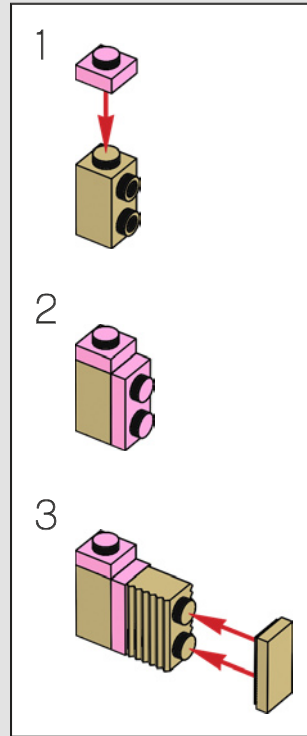

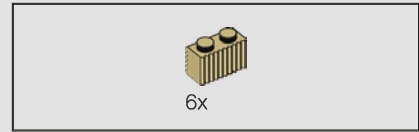
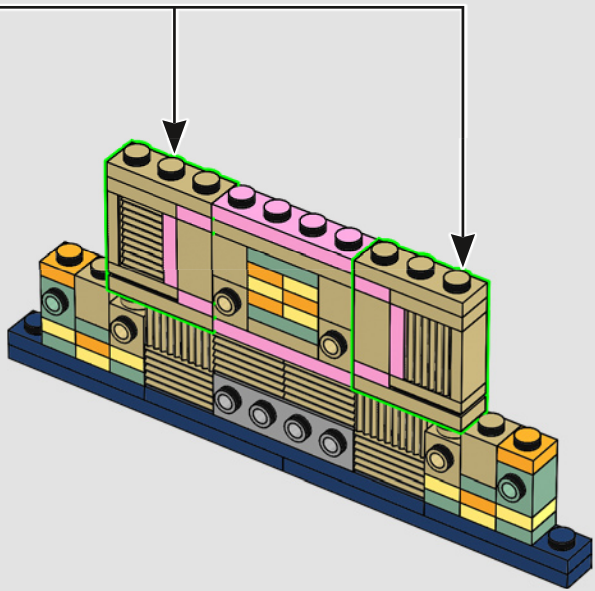

9

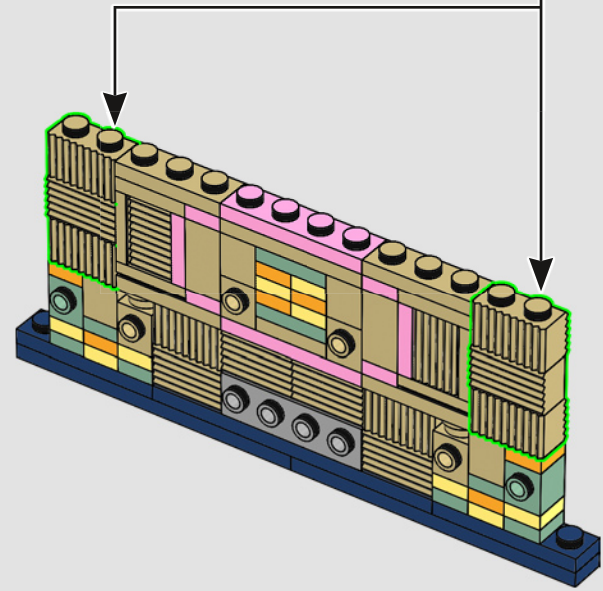
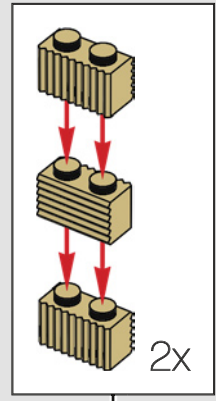

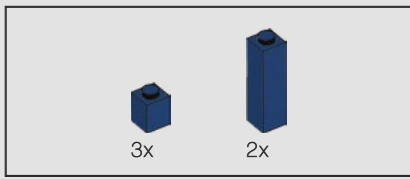

10

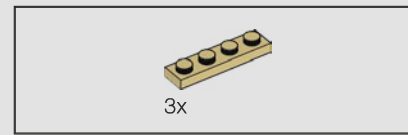
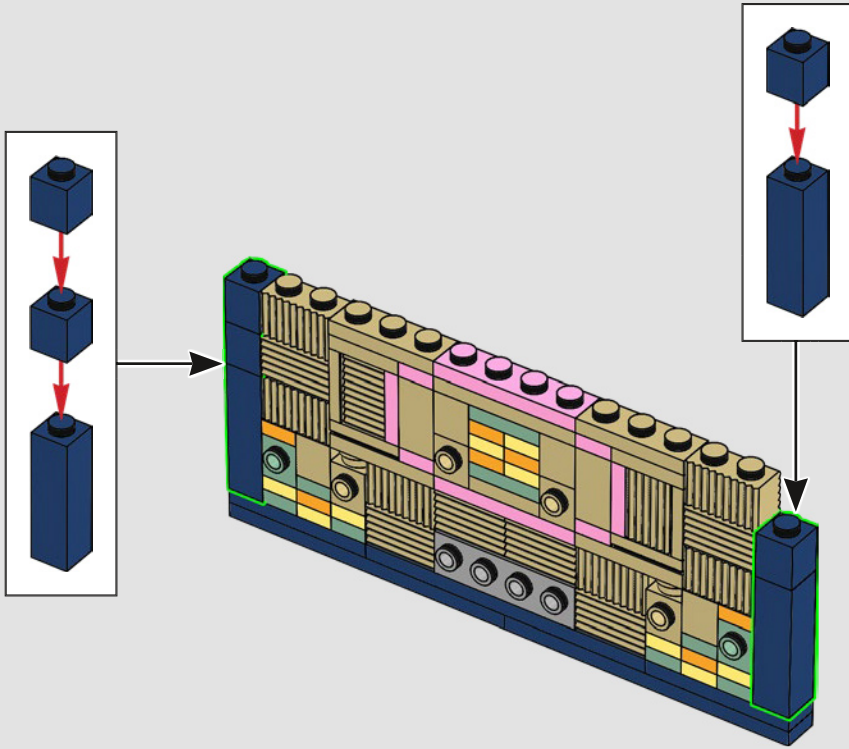

11

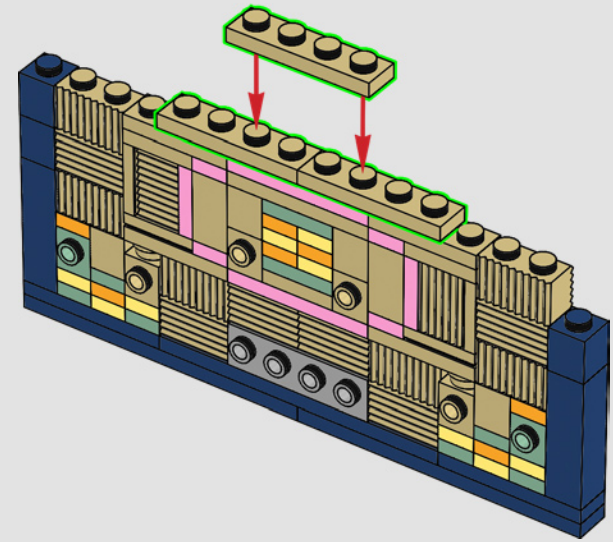

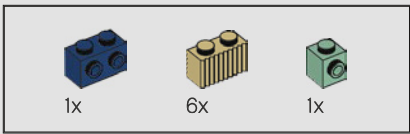

12

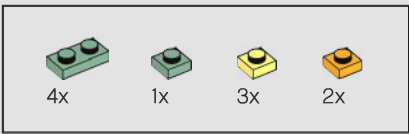
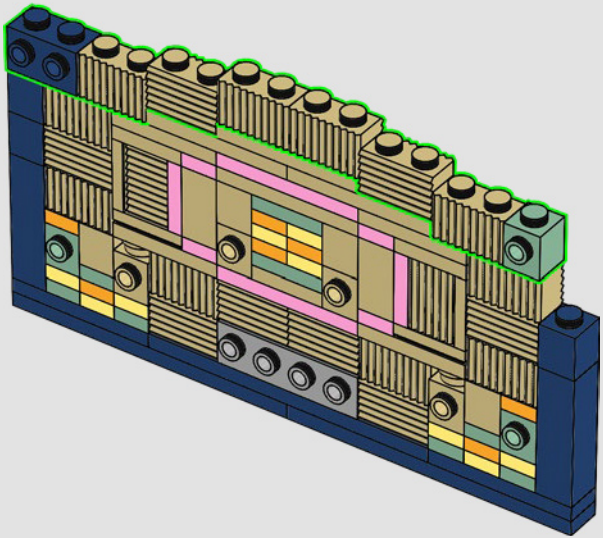

13

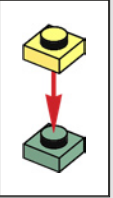
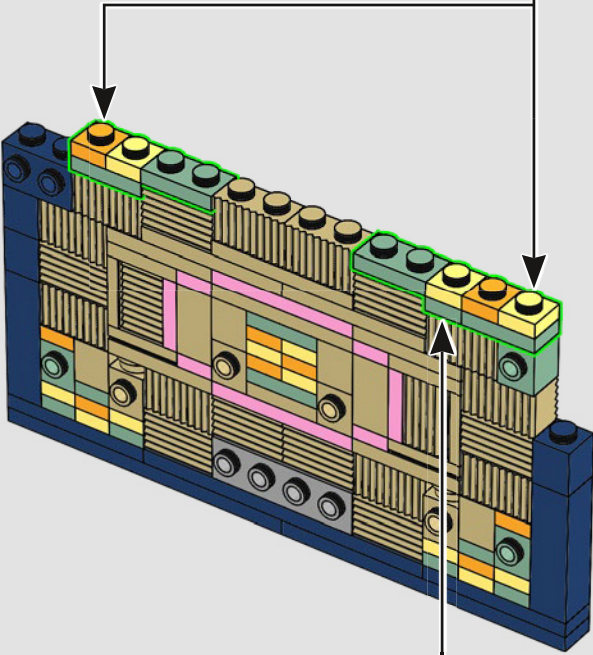
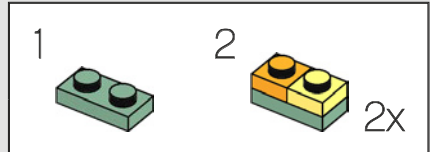

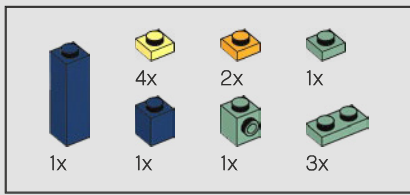

14

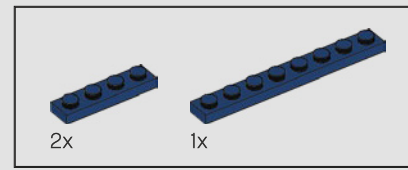
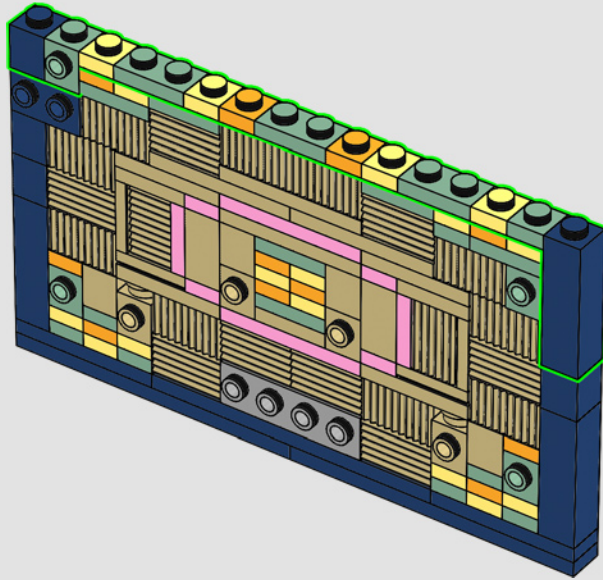

15

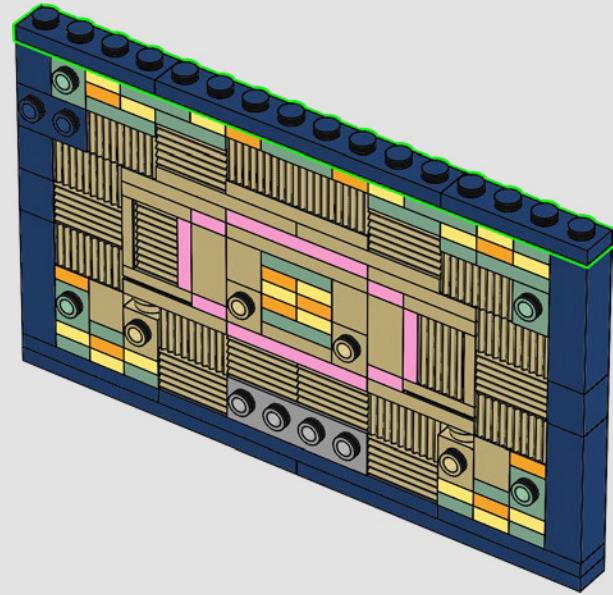

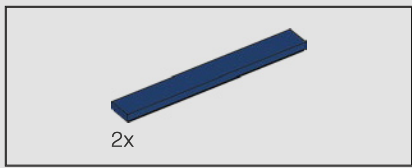

16

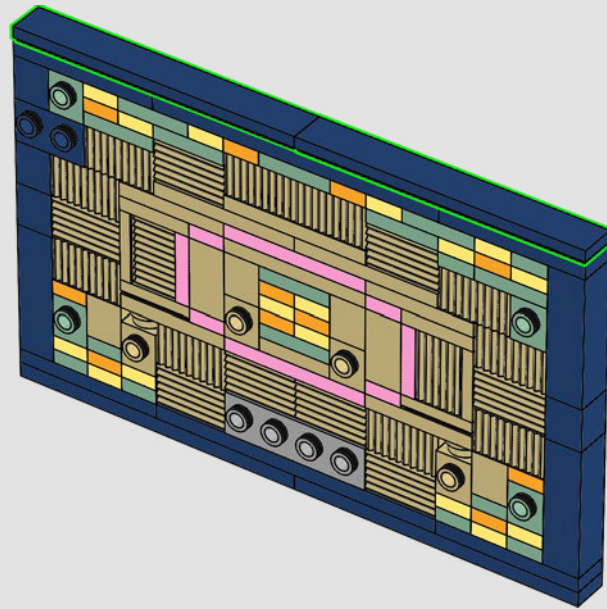

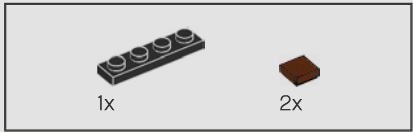
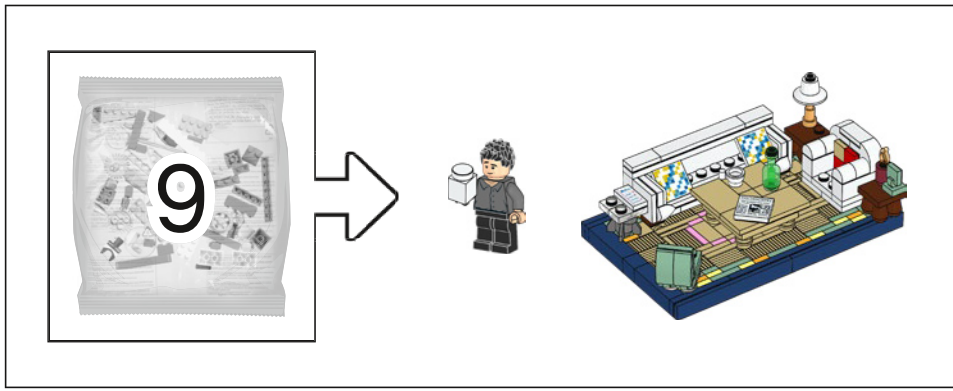

17

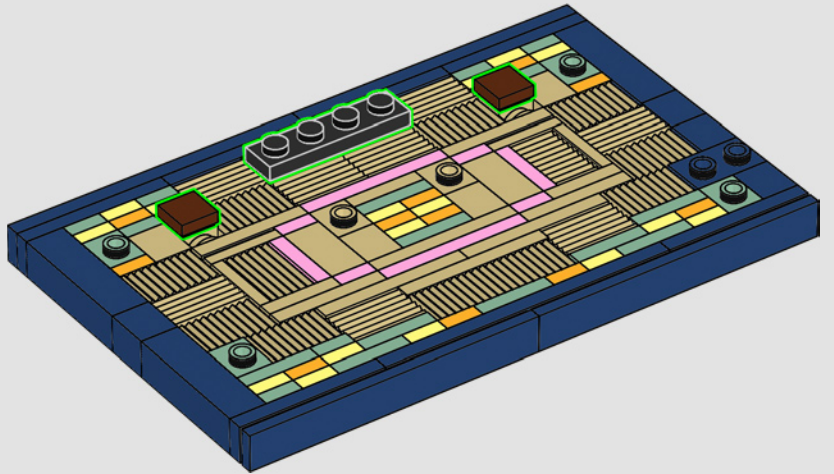
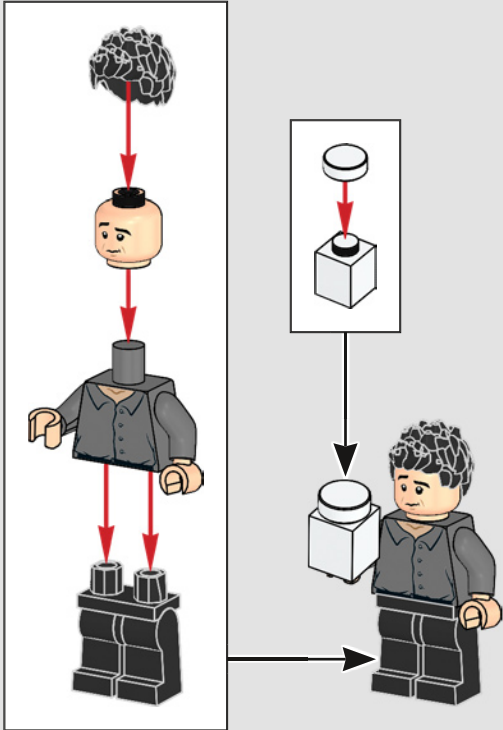

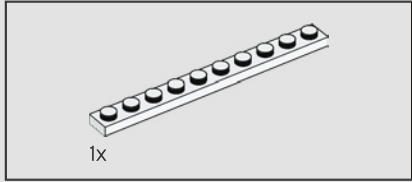
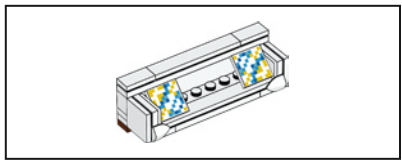

18

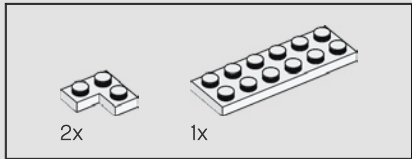
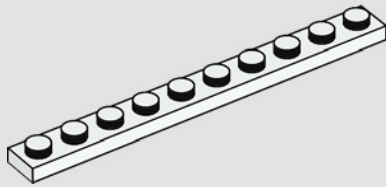

19

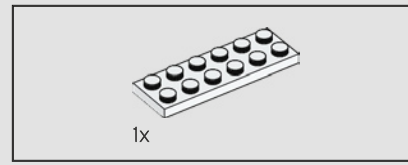
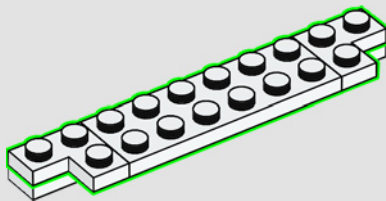

20

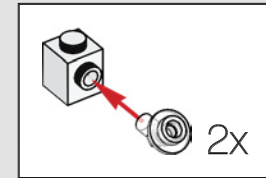
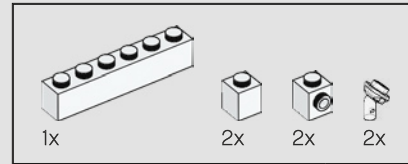
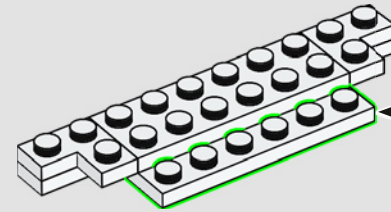
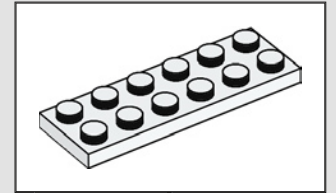

21

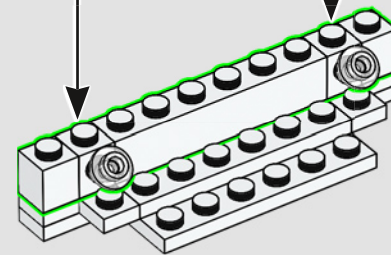

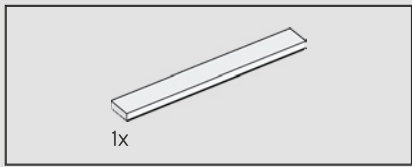

22

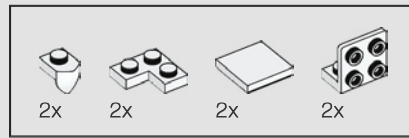
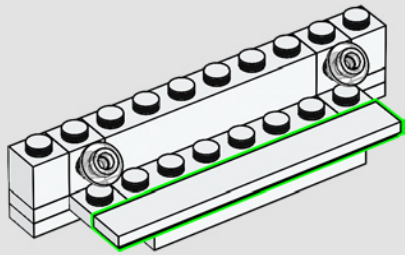

23

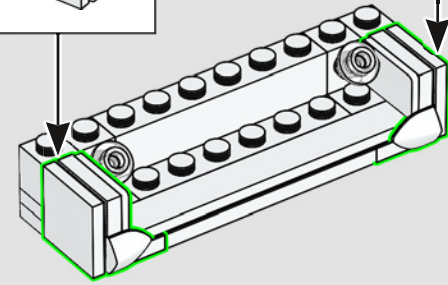
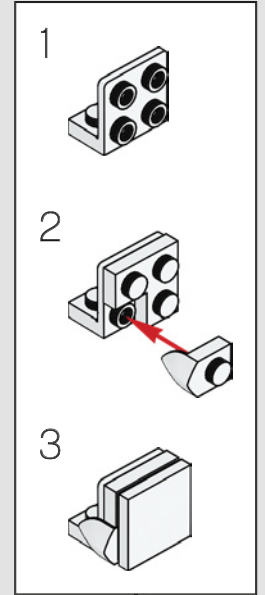
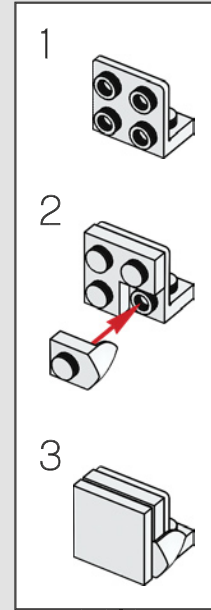

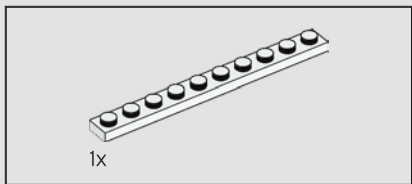

24

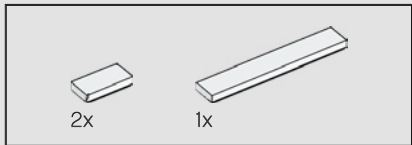
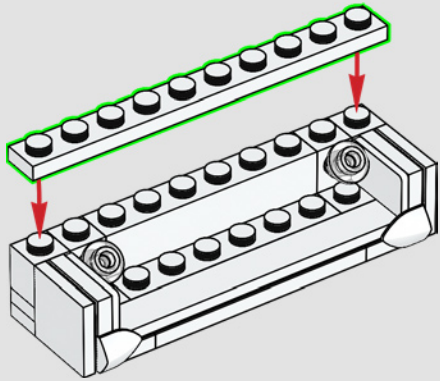

25

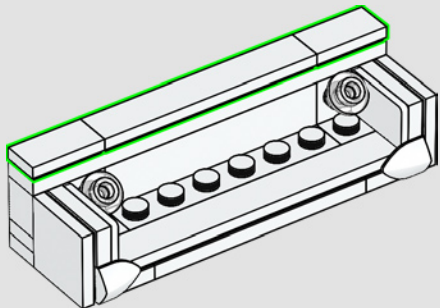

26

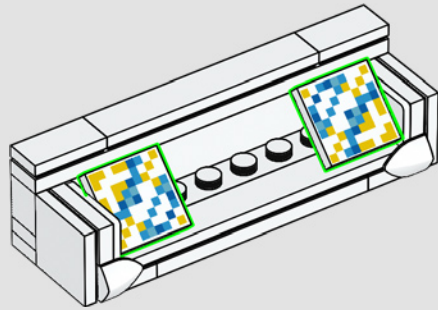

27

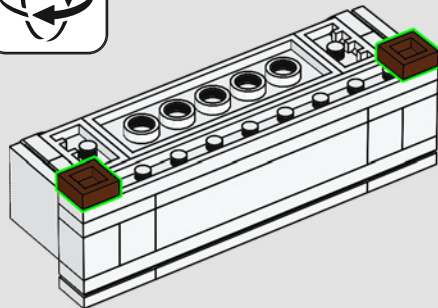

28

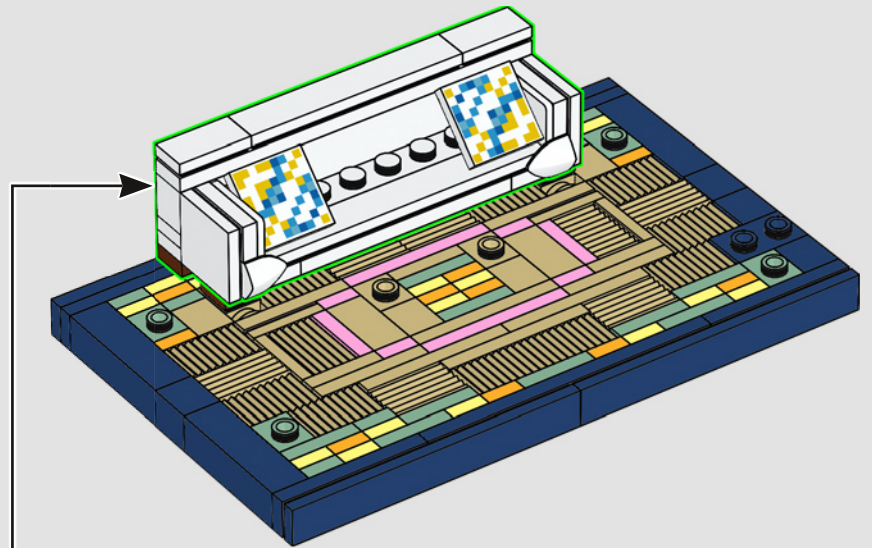

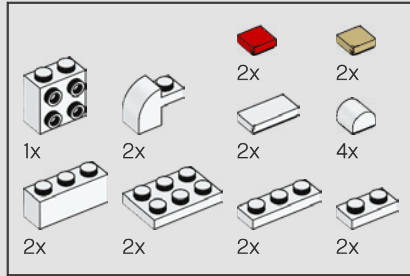
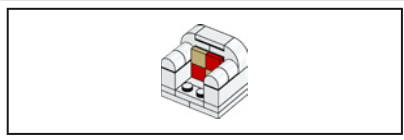

29

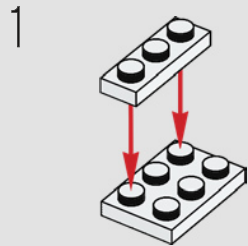

2

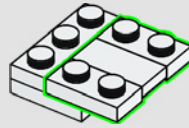

3

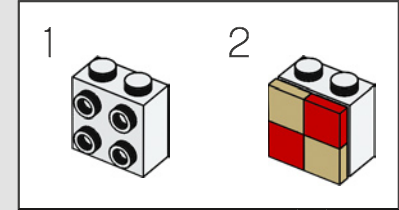
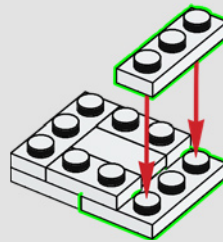

4

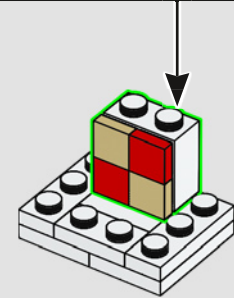

5

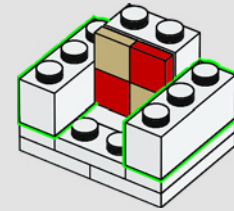

6

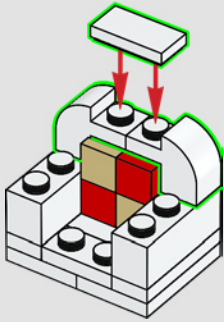

7

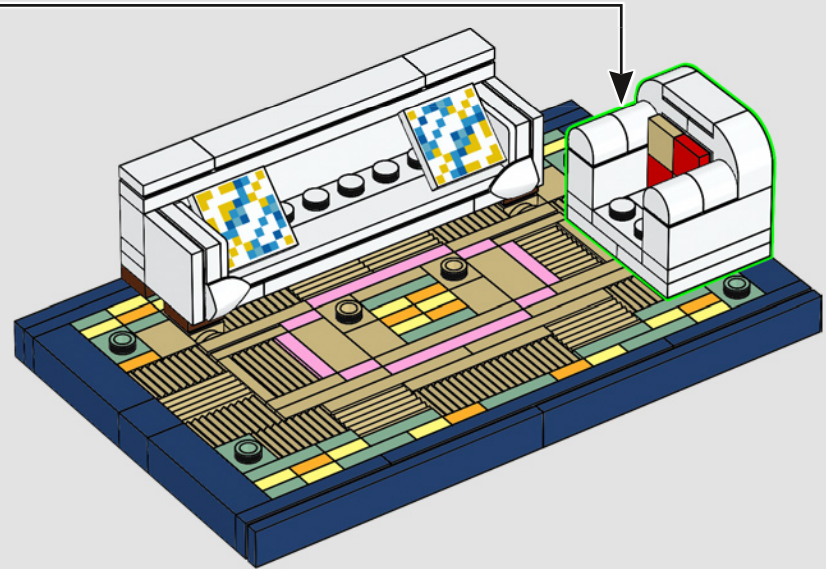
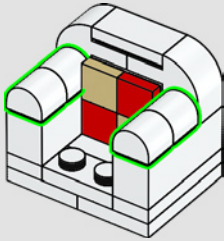

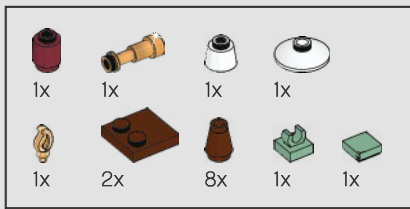

30

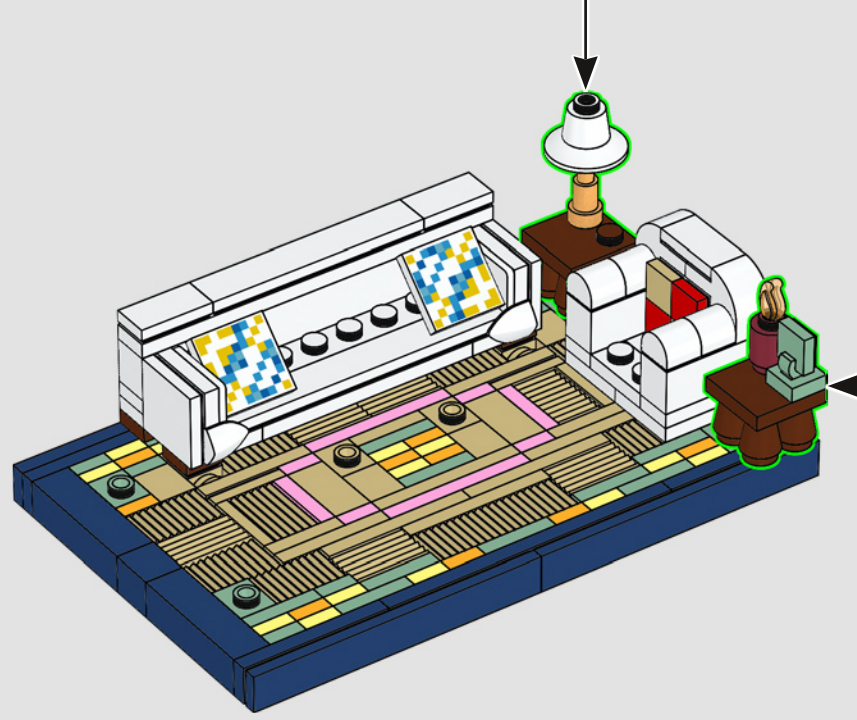
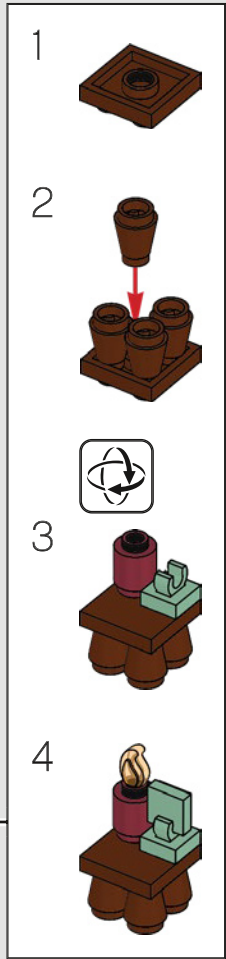
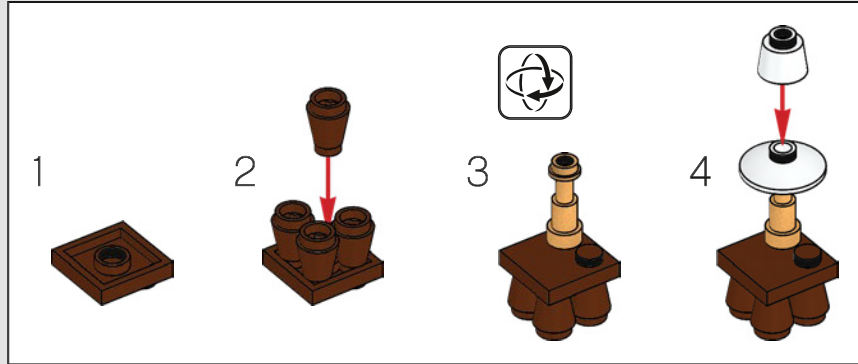

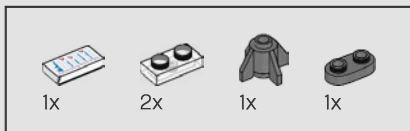

32

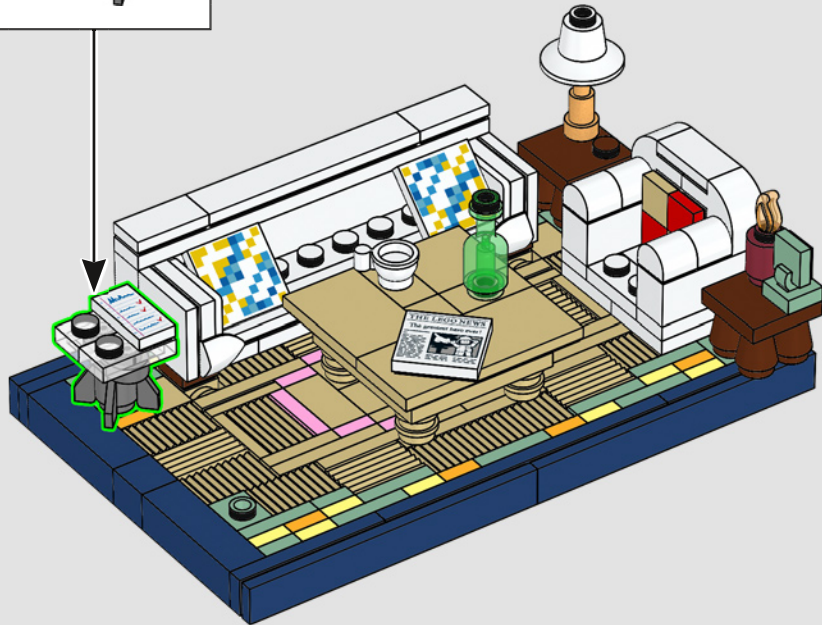
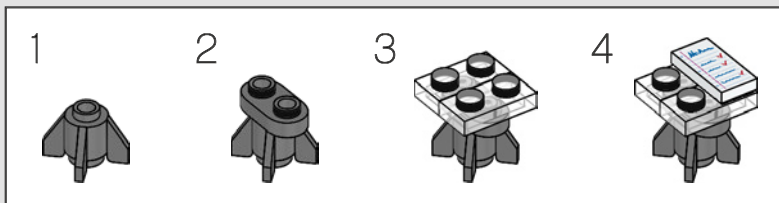

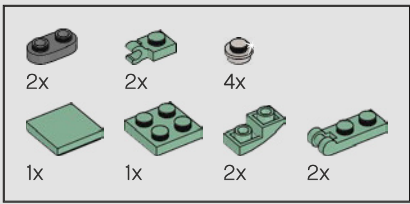

33

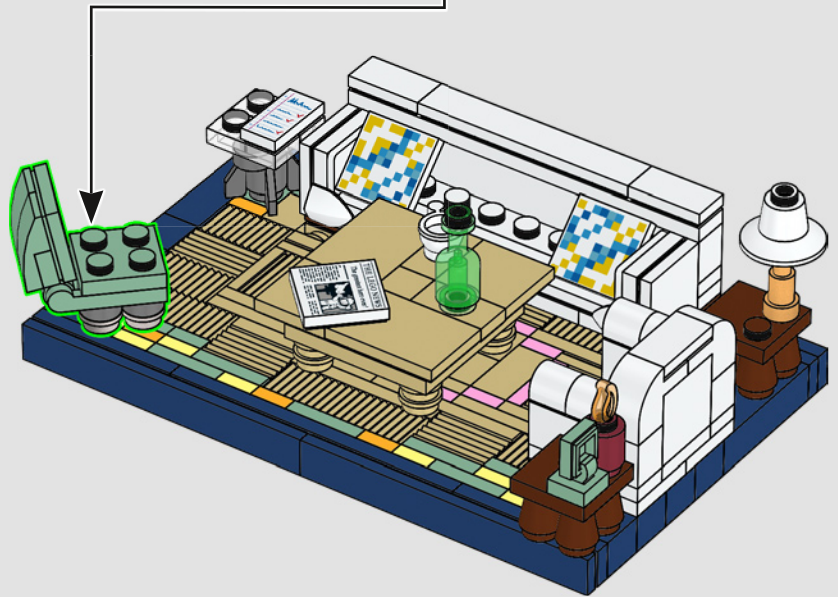
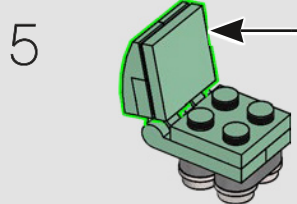
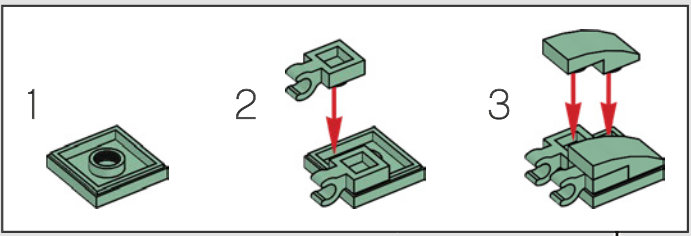
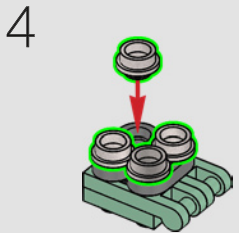
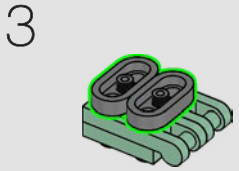
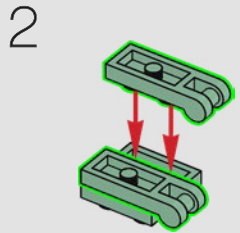
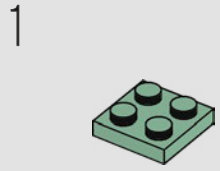

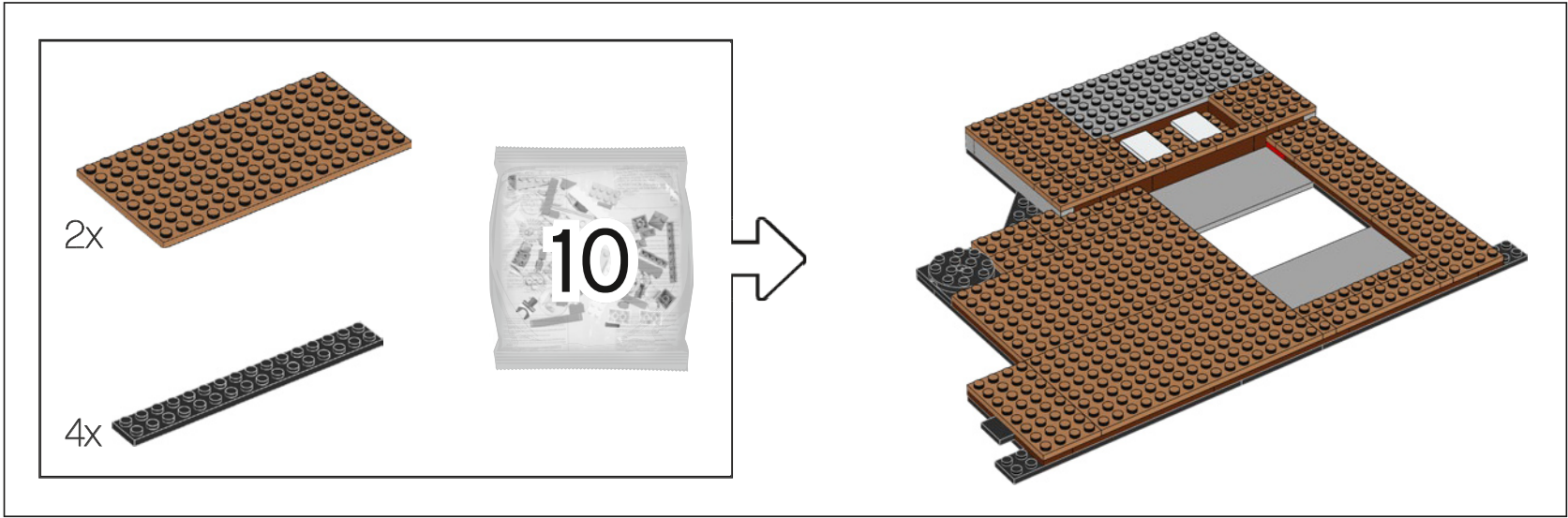

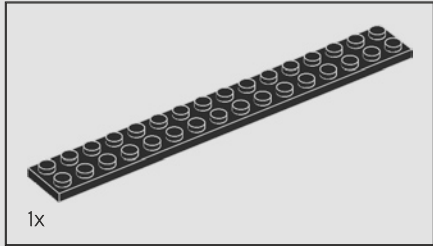
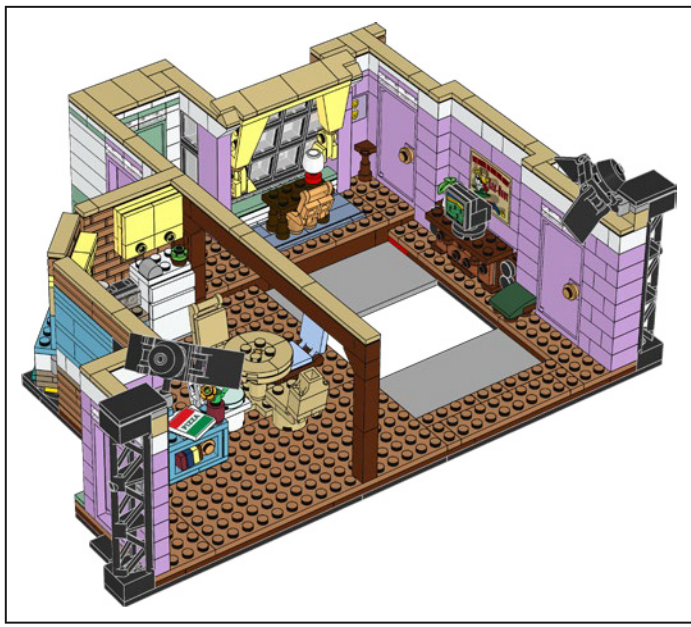

1

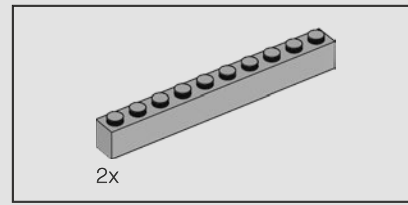
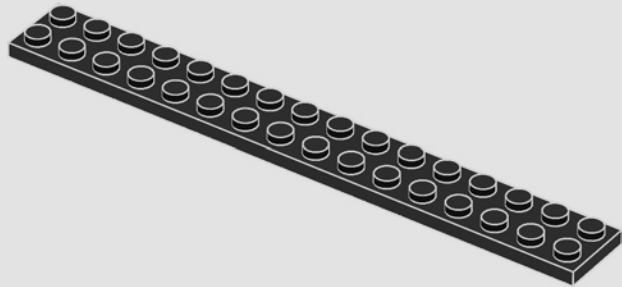

2

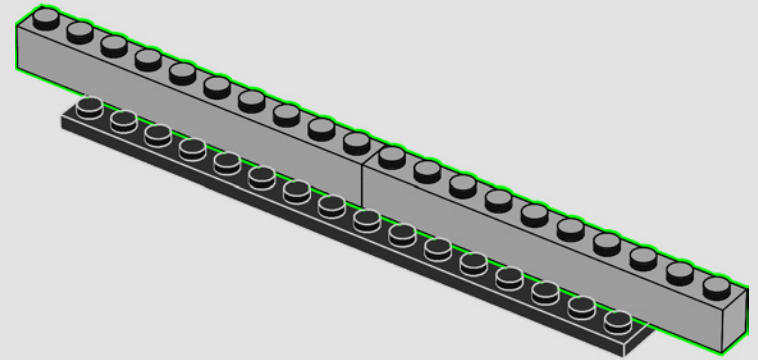

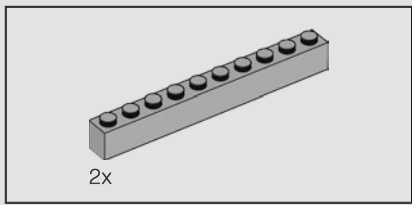

4

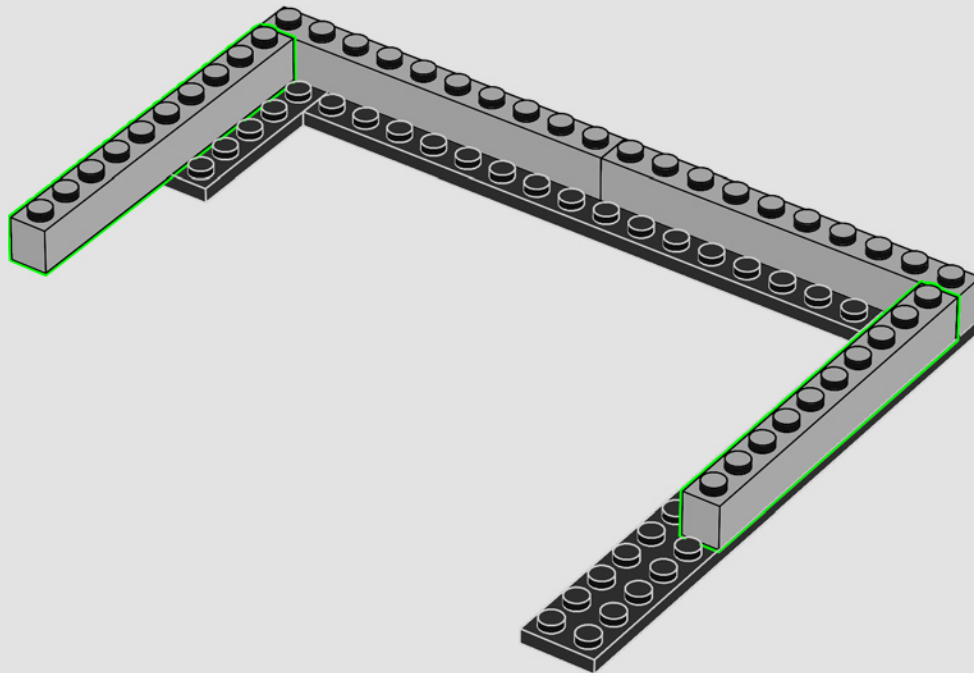

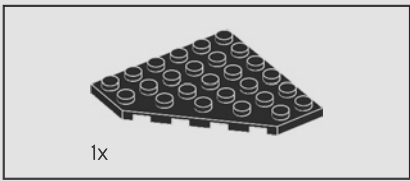

5

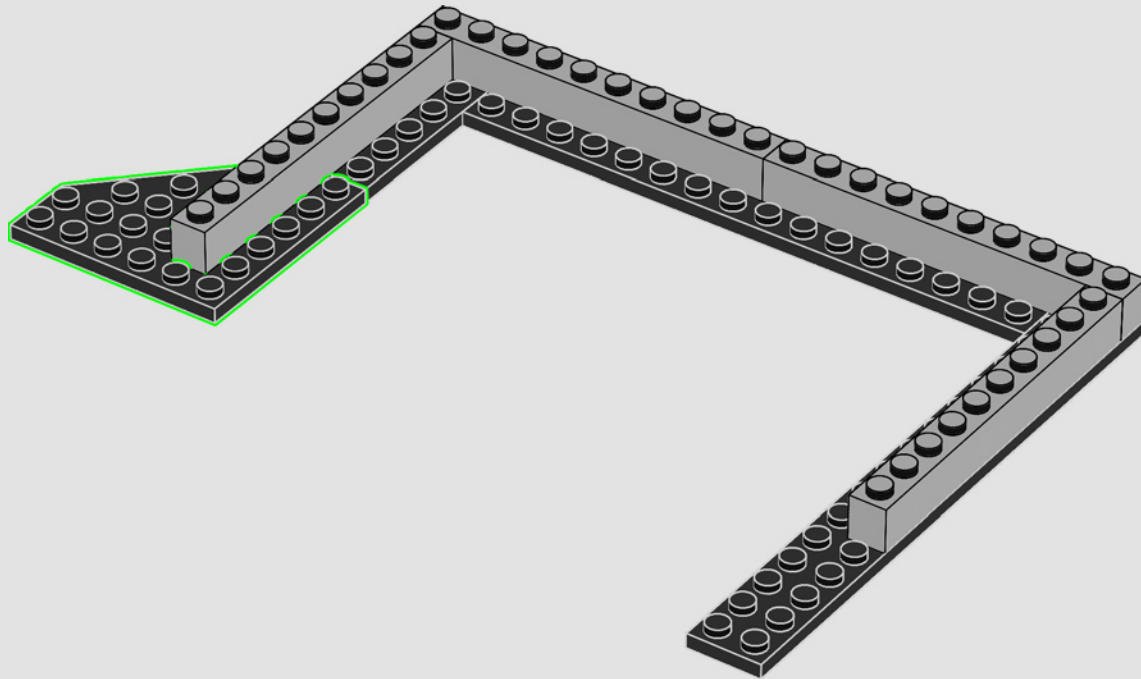

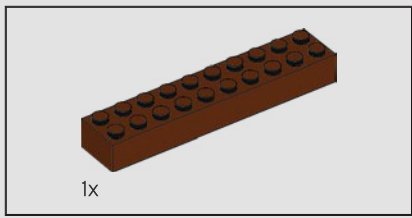

6

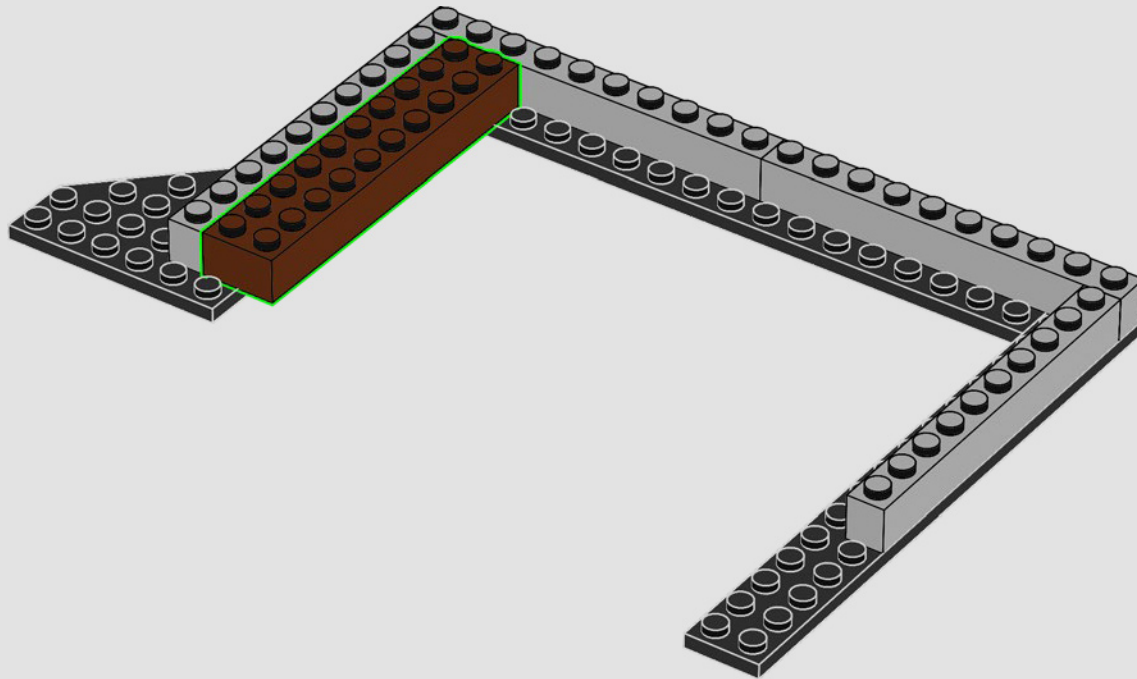

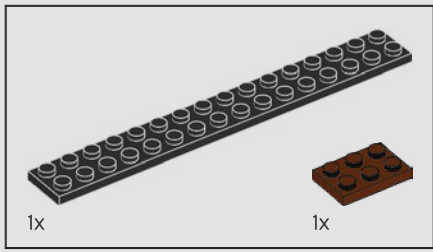

7

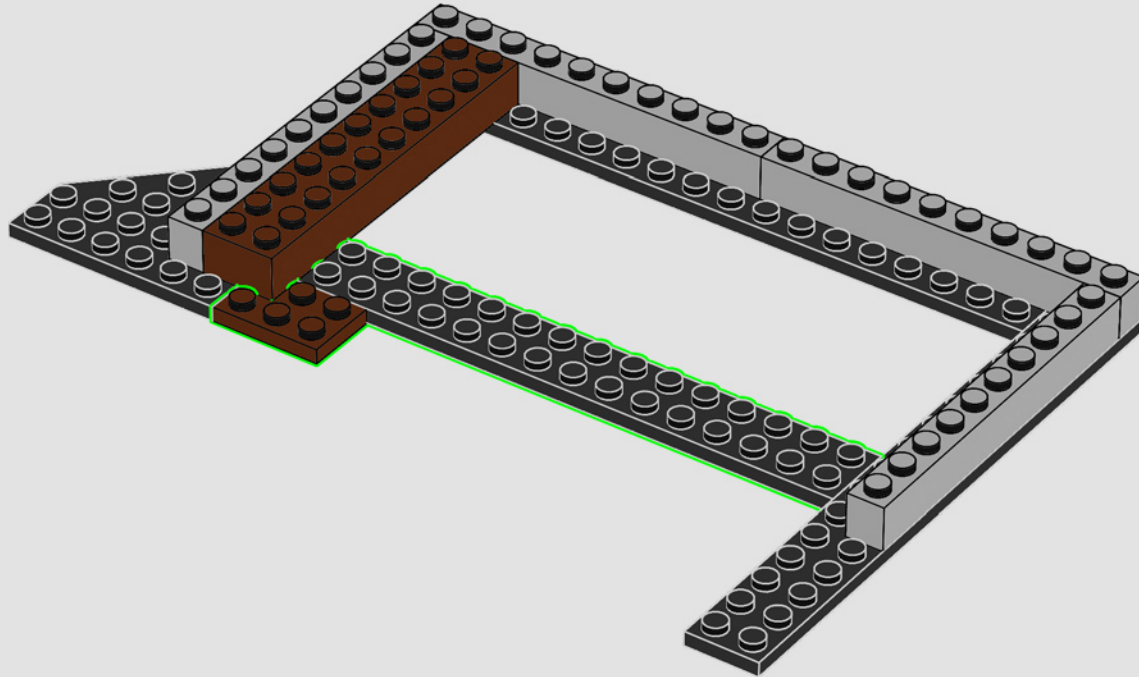

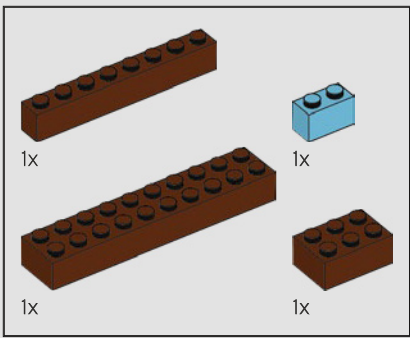

8

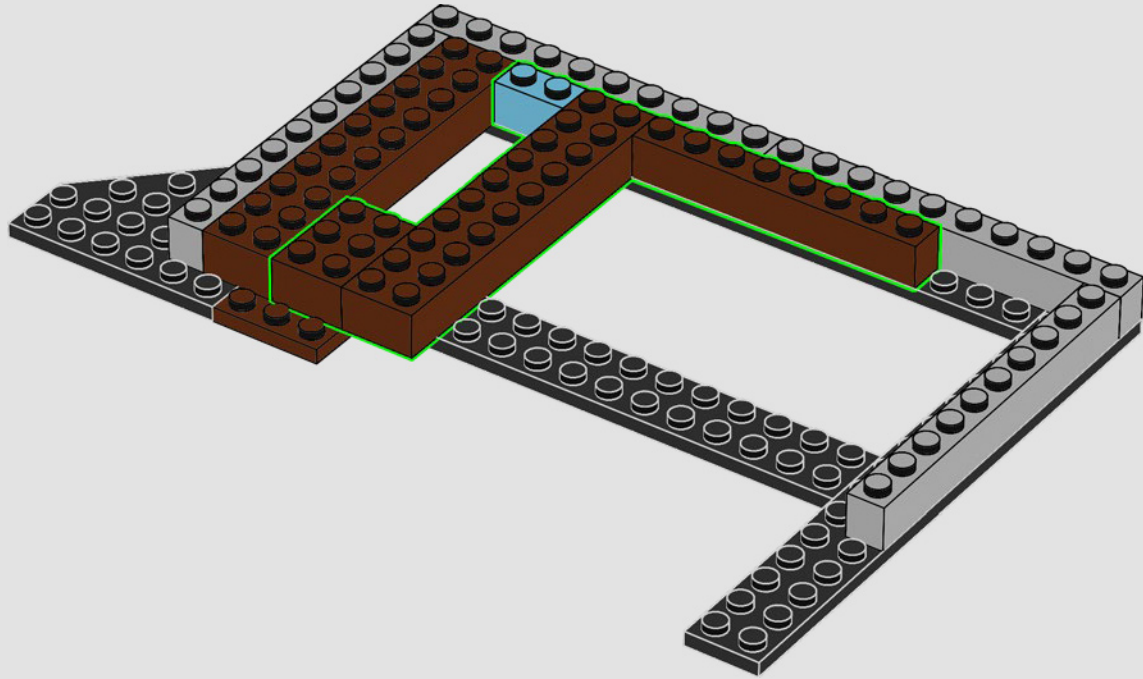

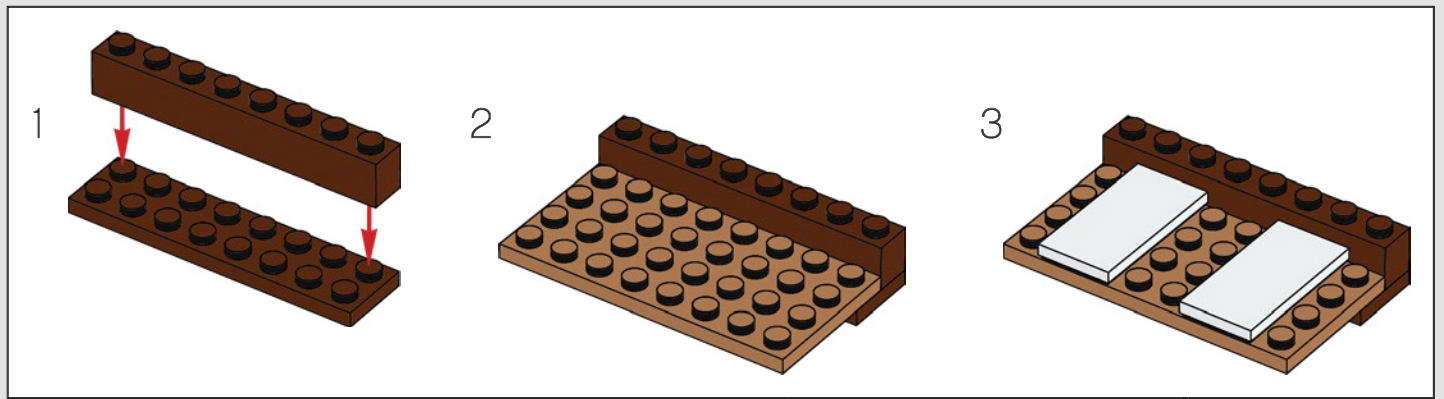
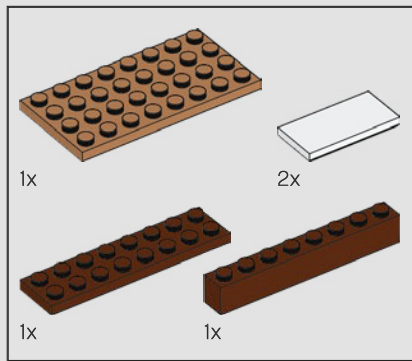

9

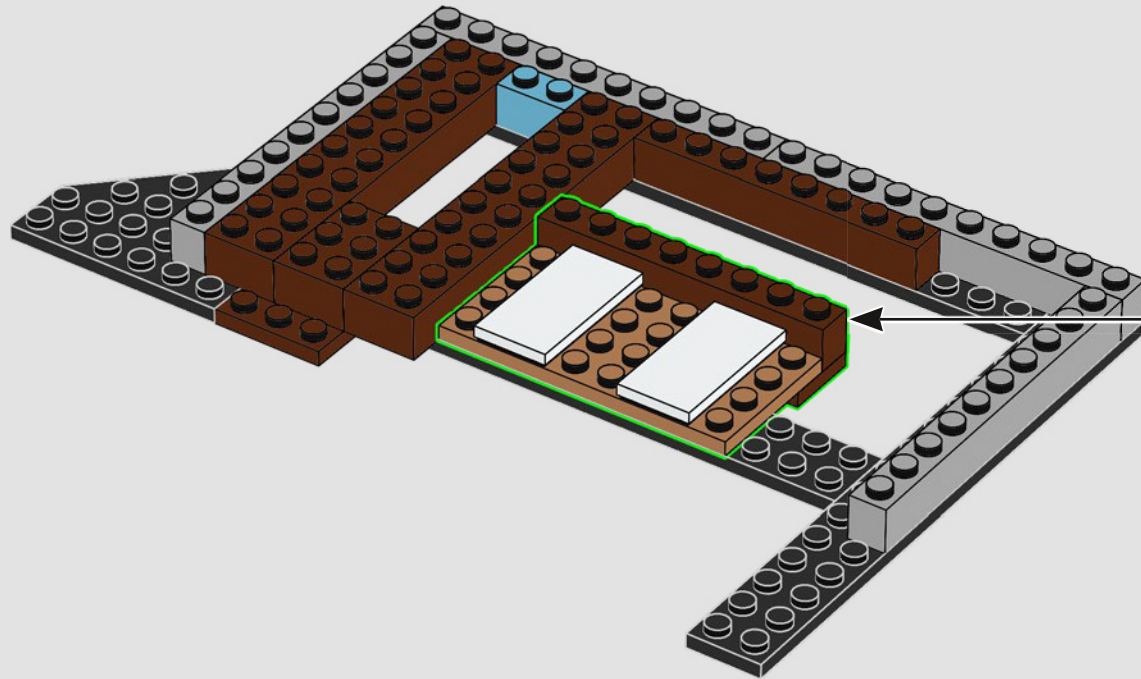

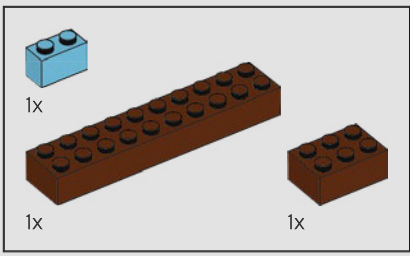

10

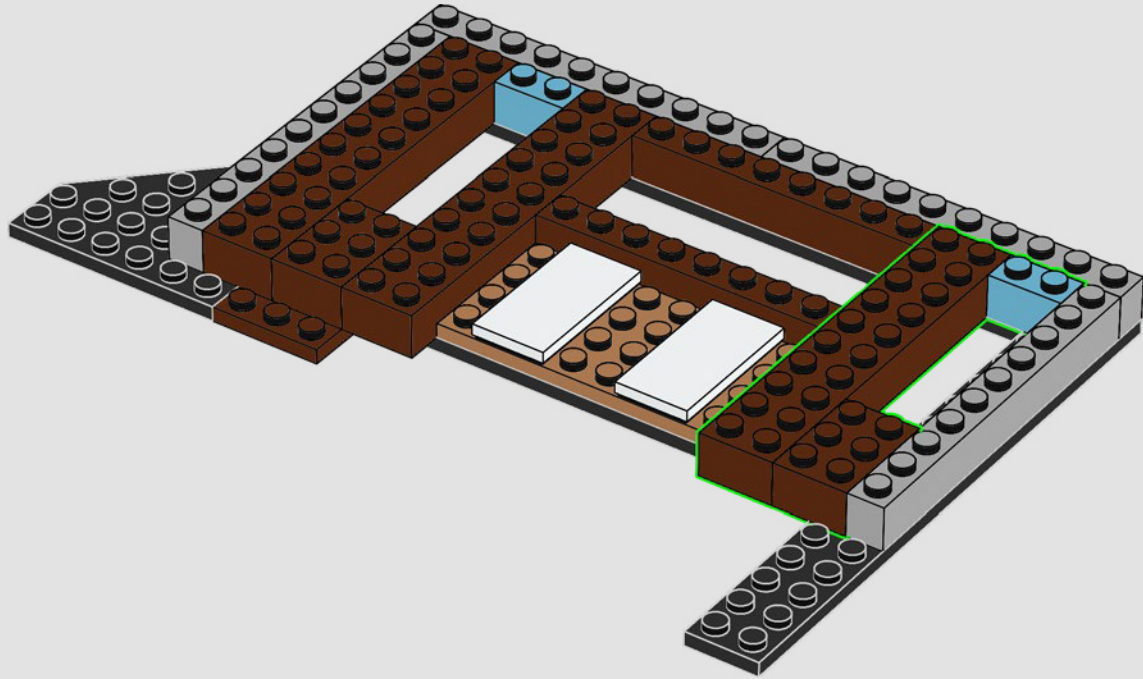

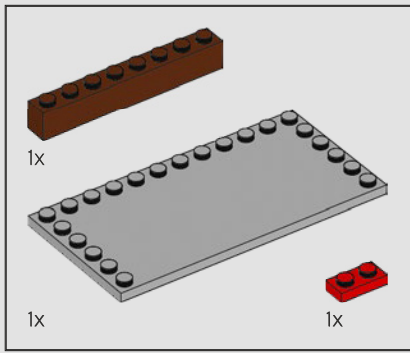

11

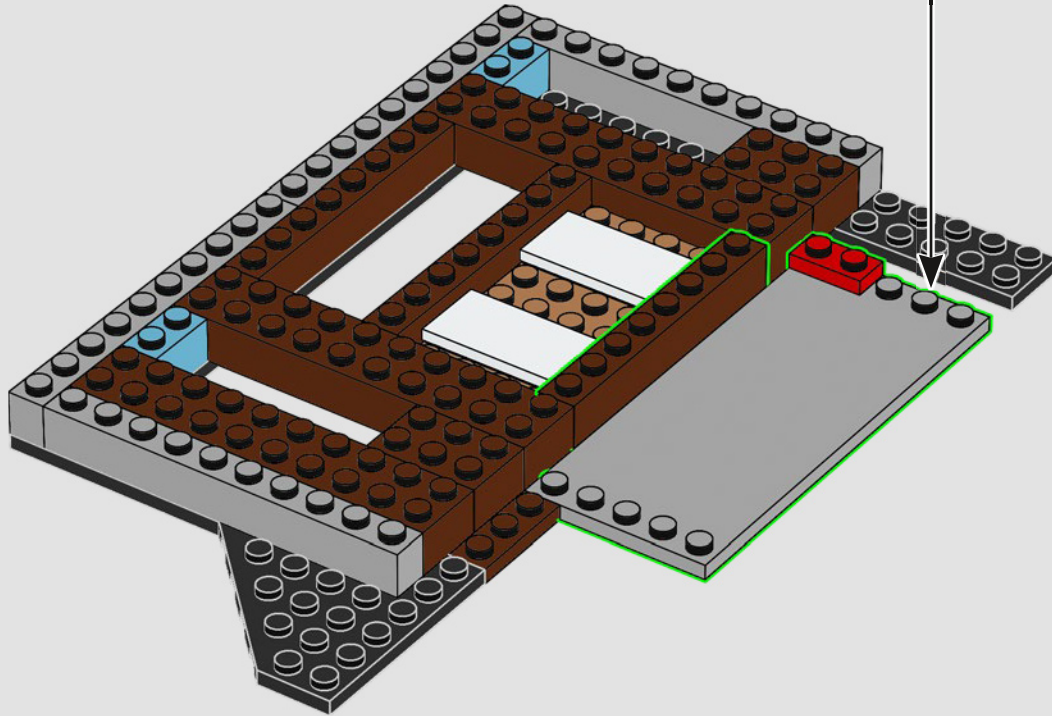
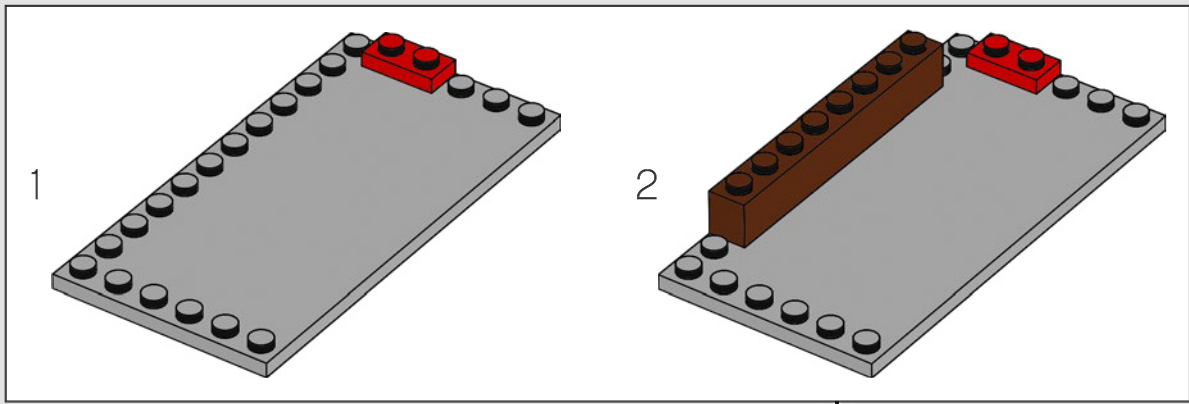

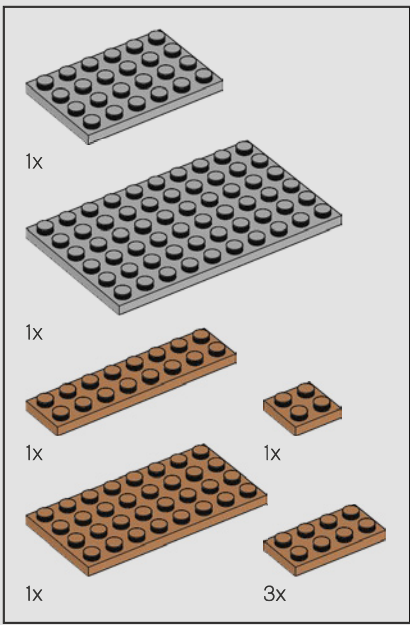

12

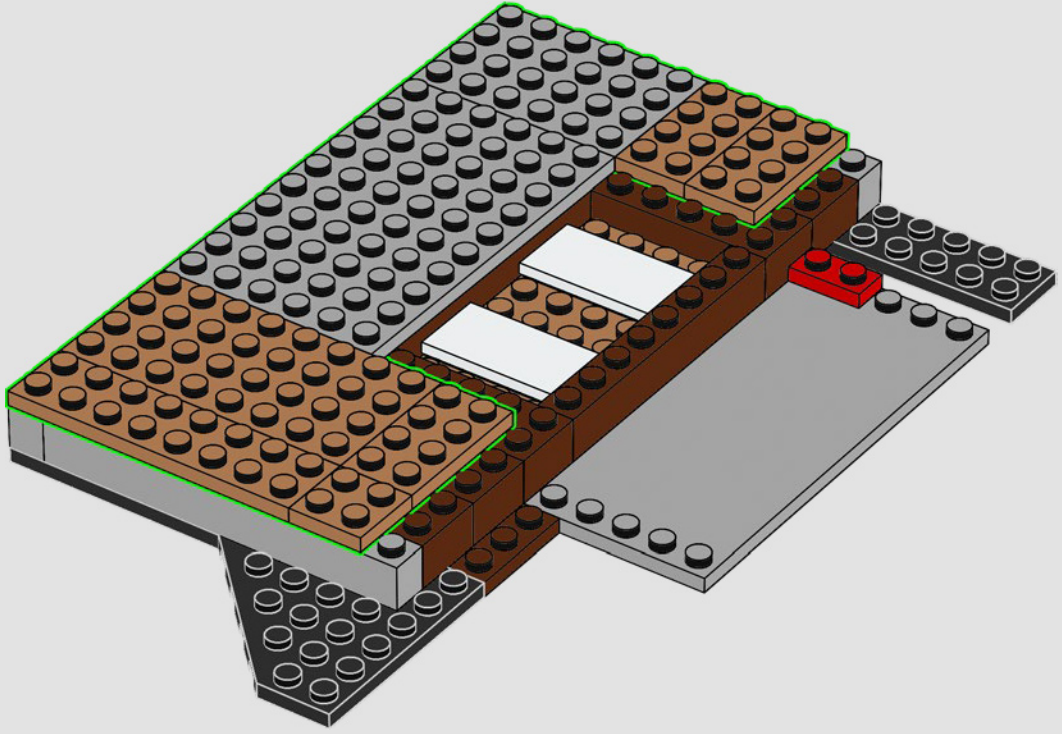

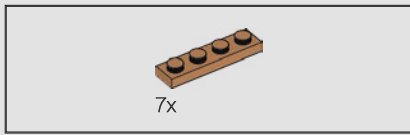

13

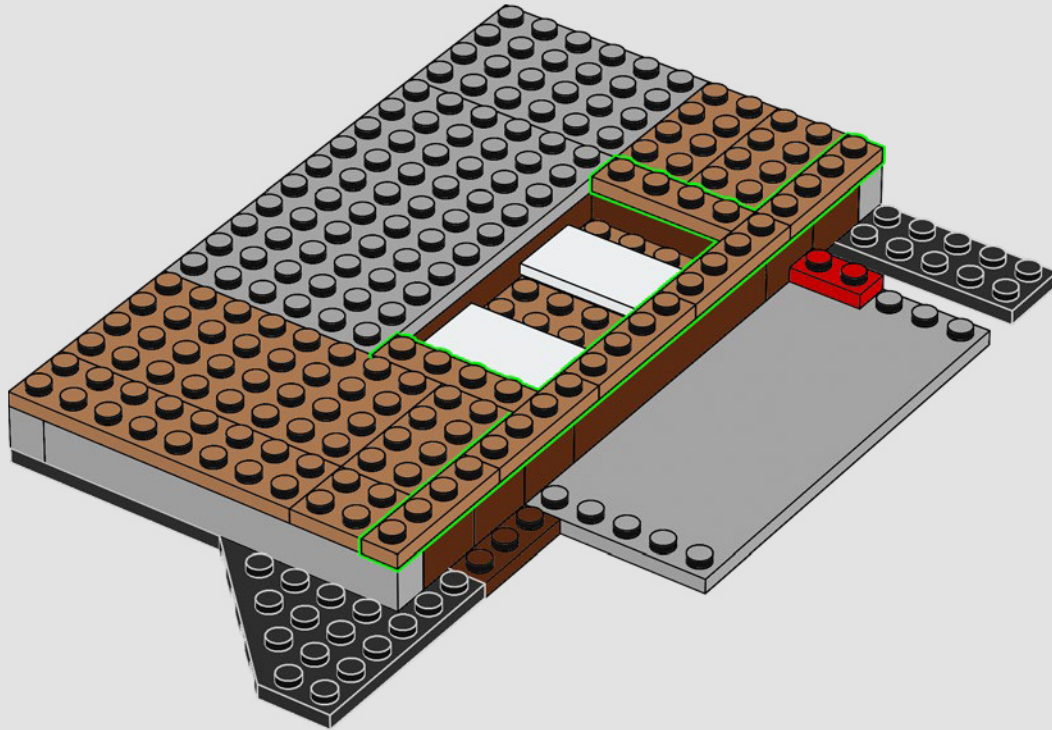

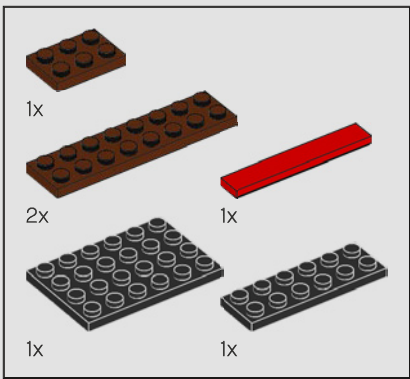

14

1

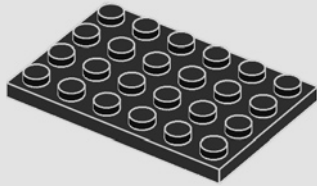

2

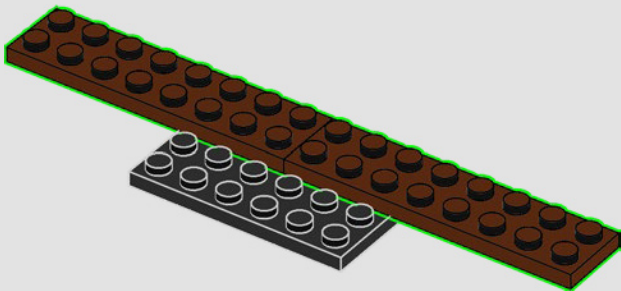

3

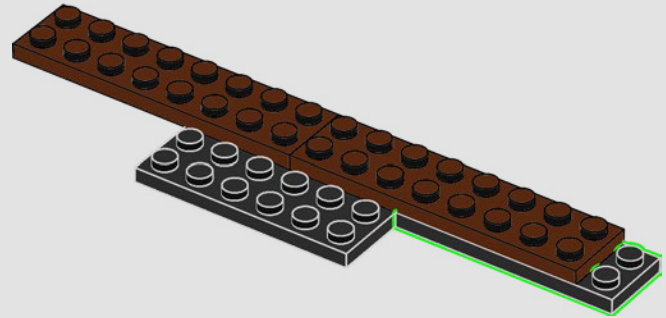

4

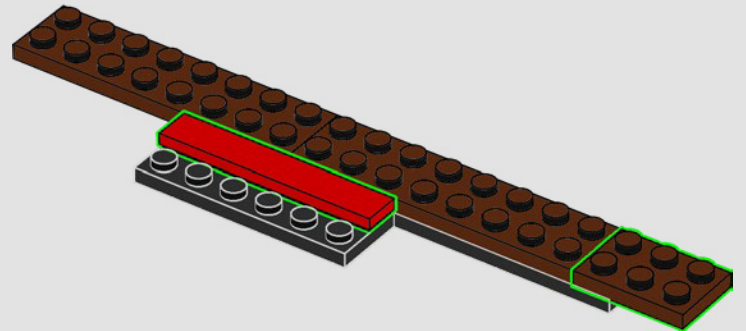

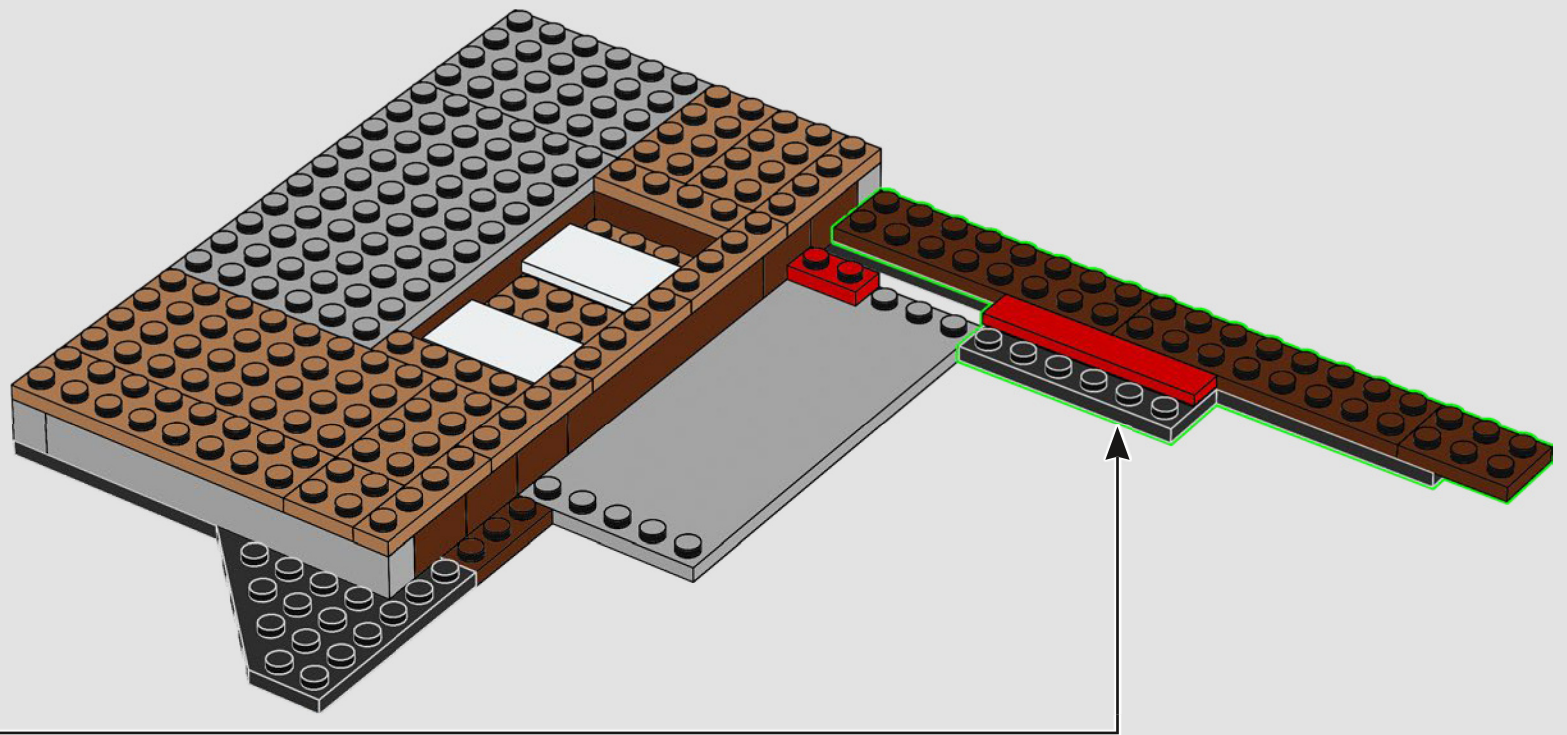

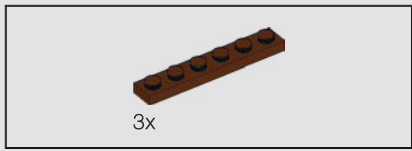

15

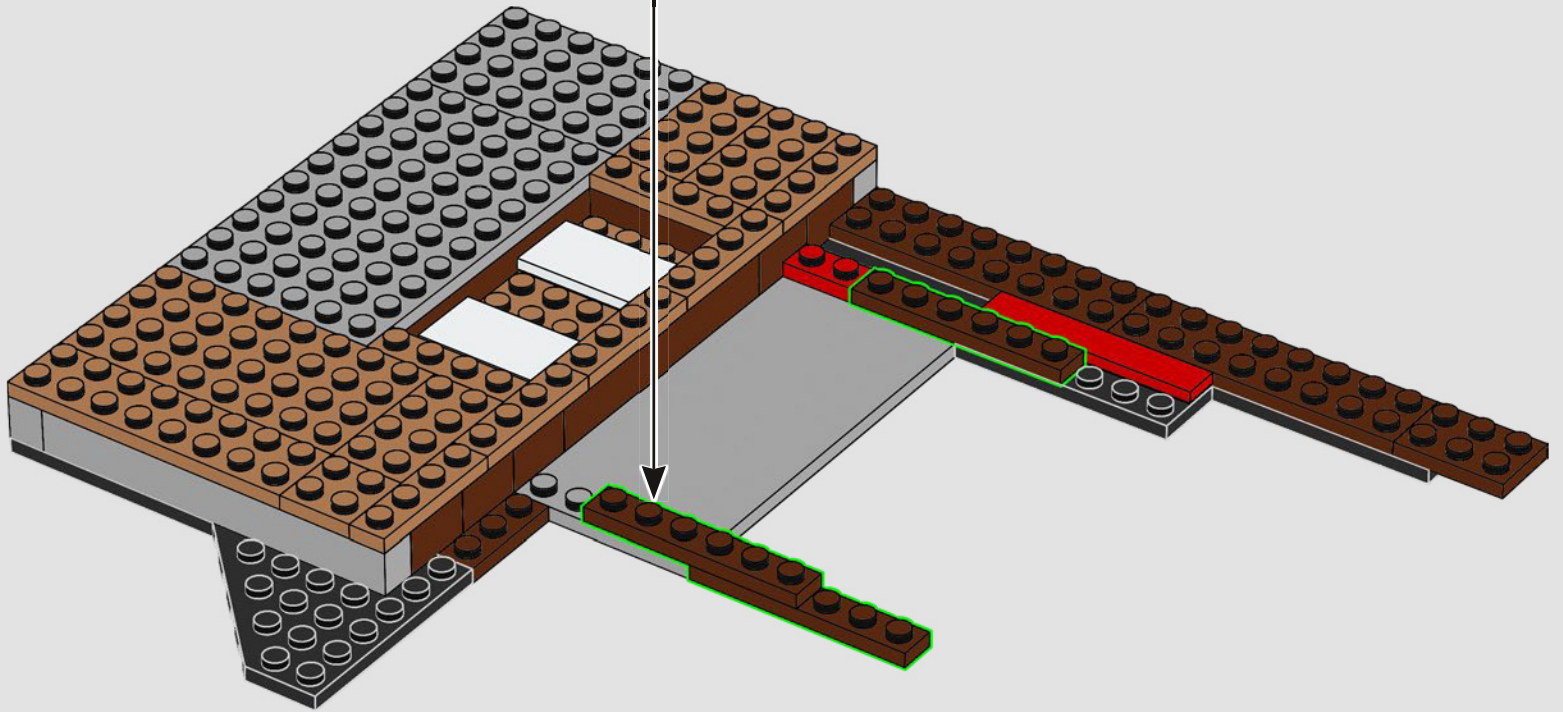
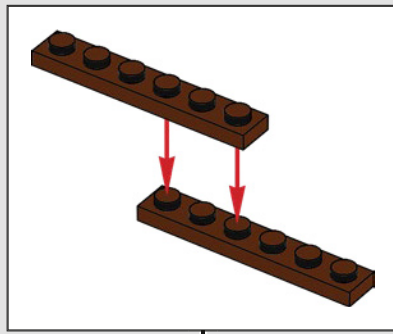

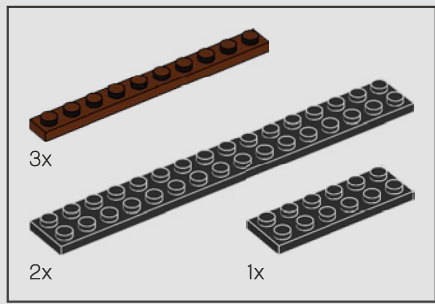

16

1

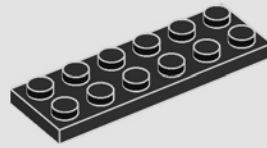

2

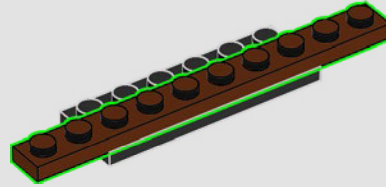

3

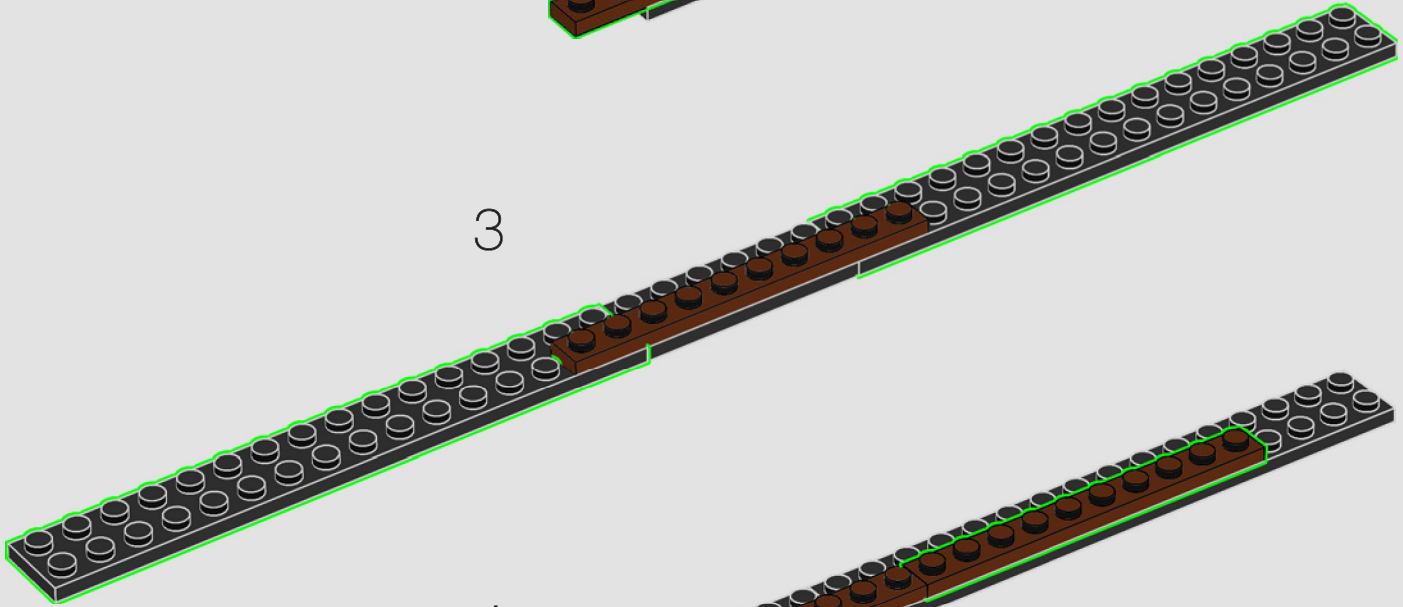

4

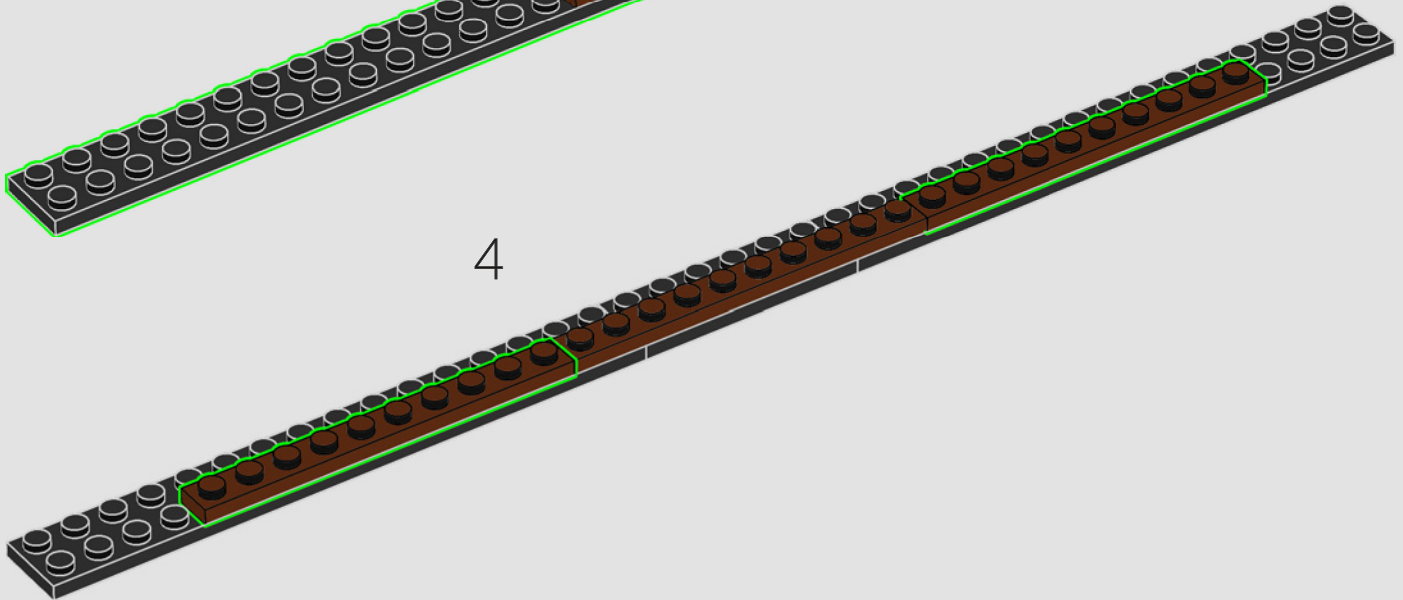

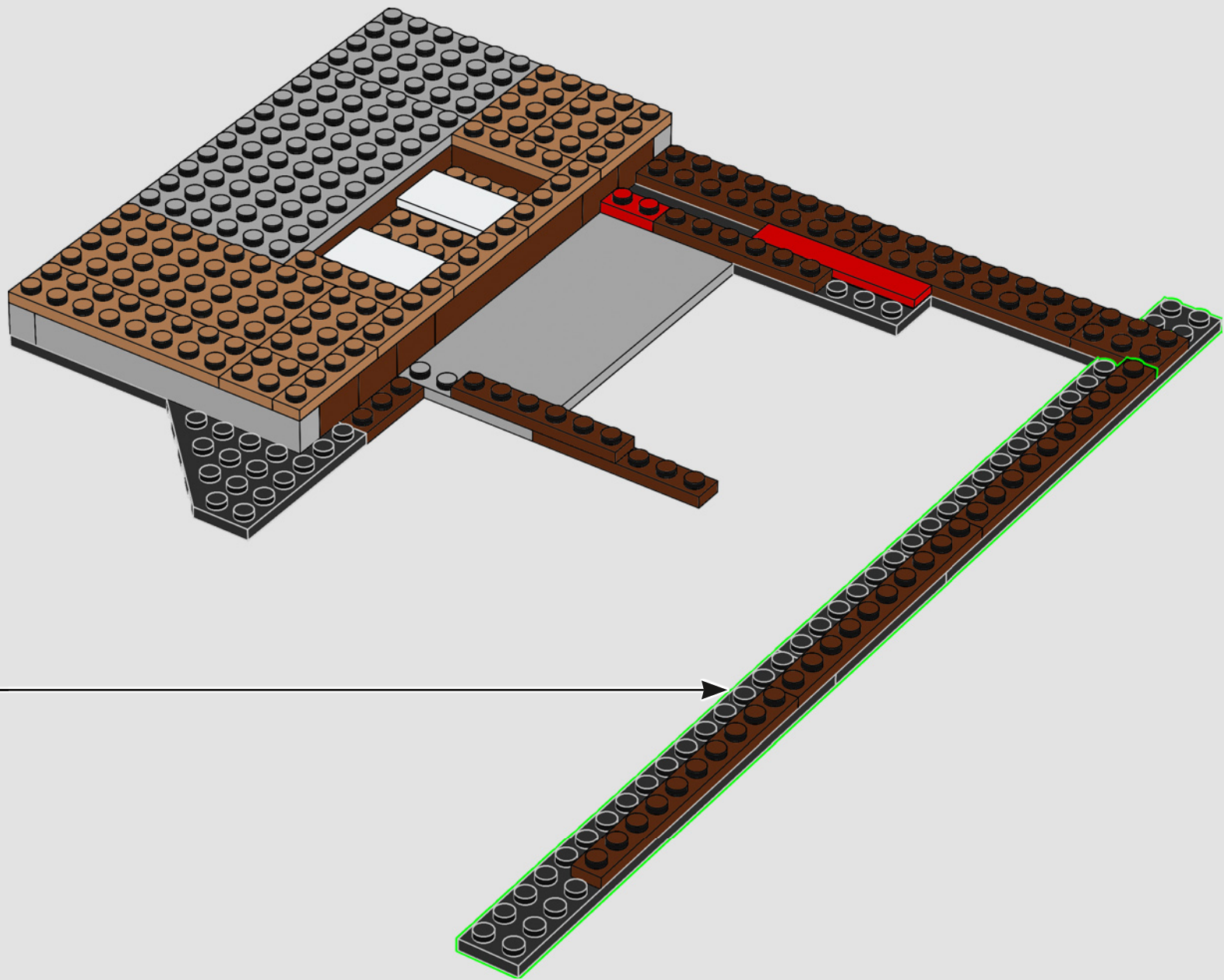

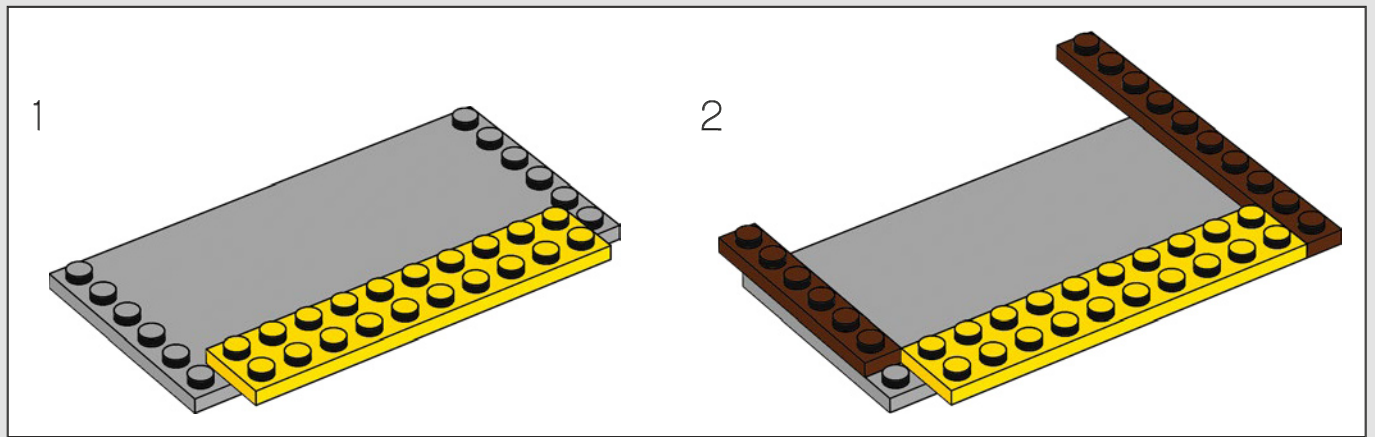
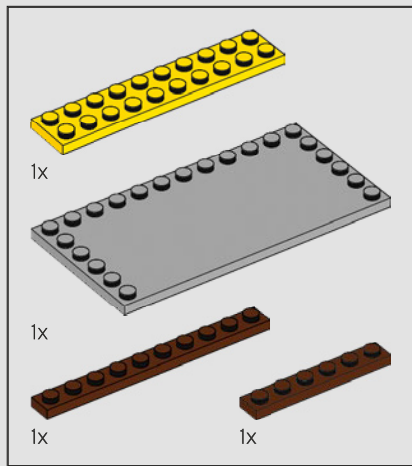

17

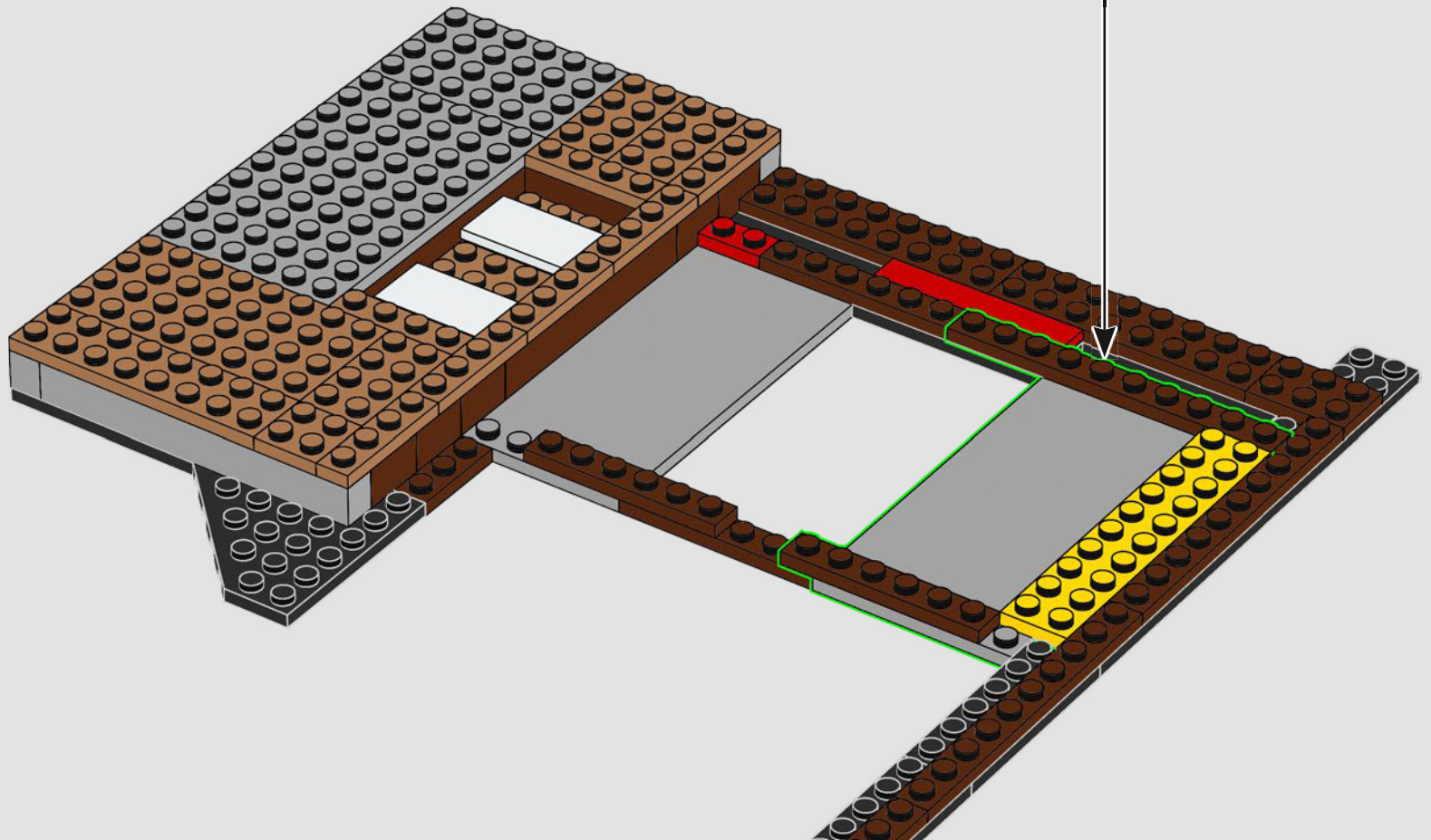

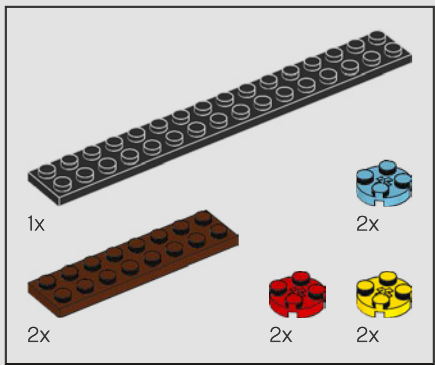

18

1

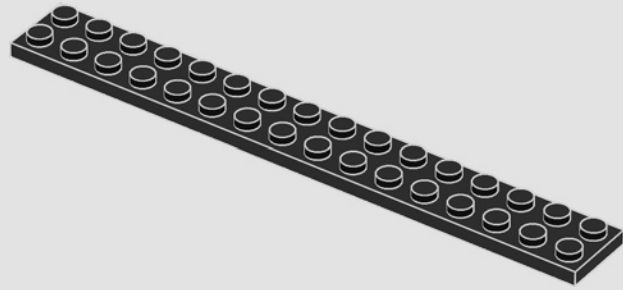

2

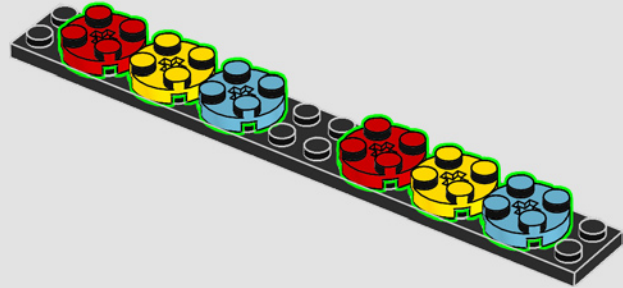

3

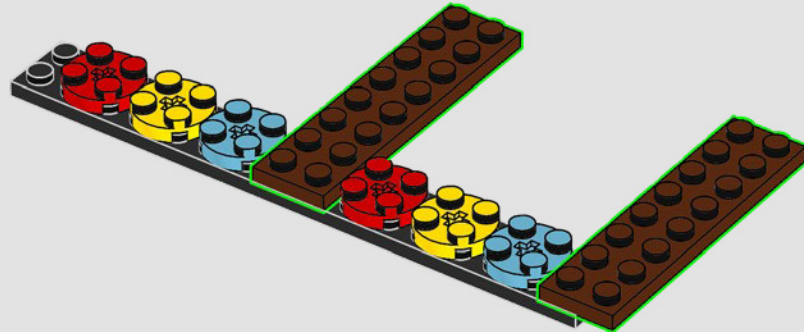

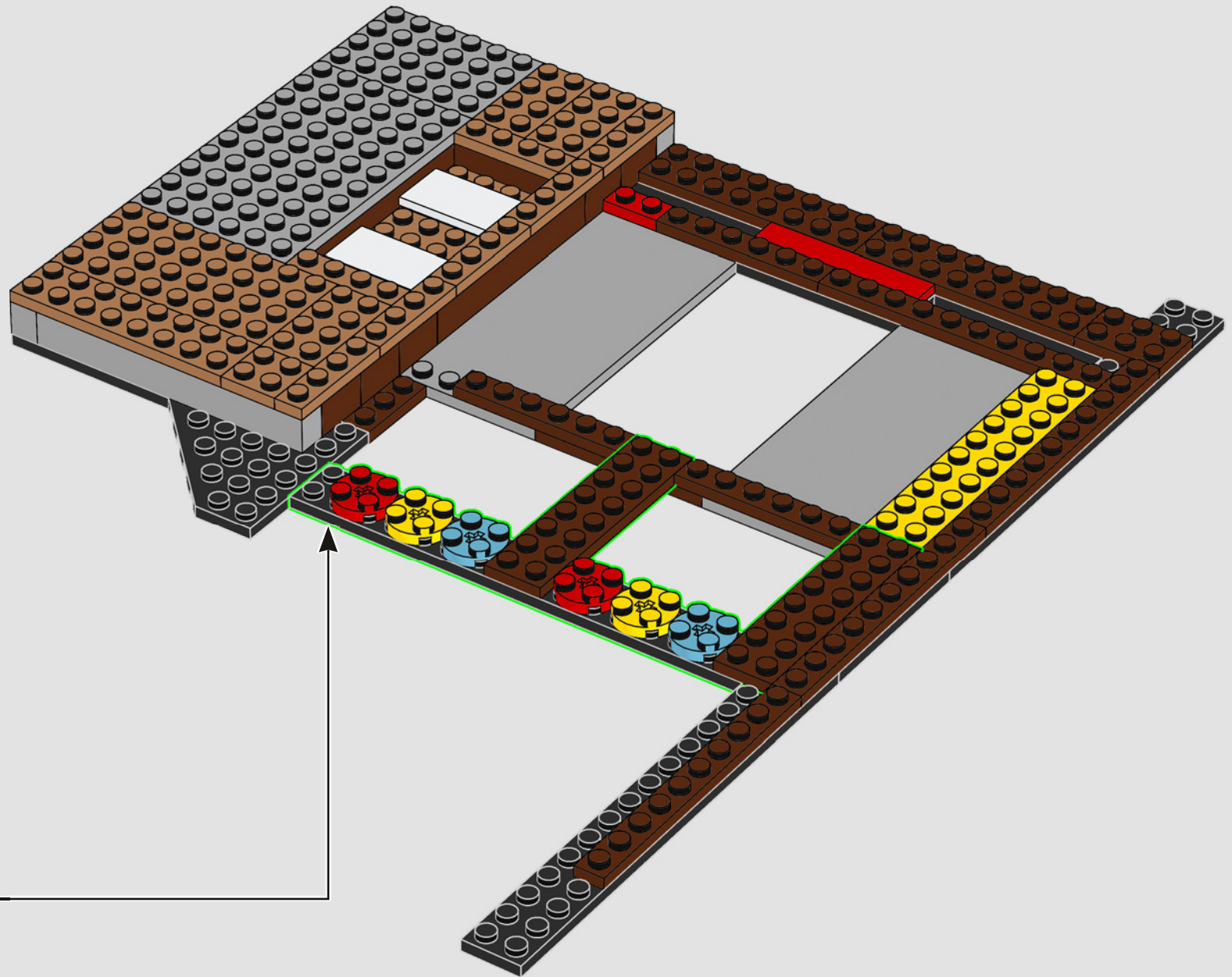

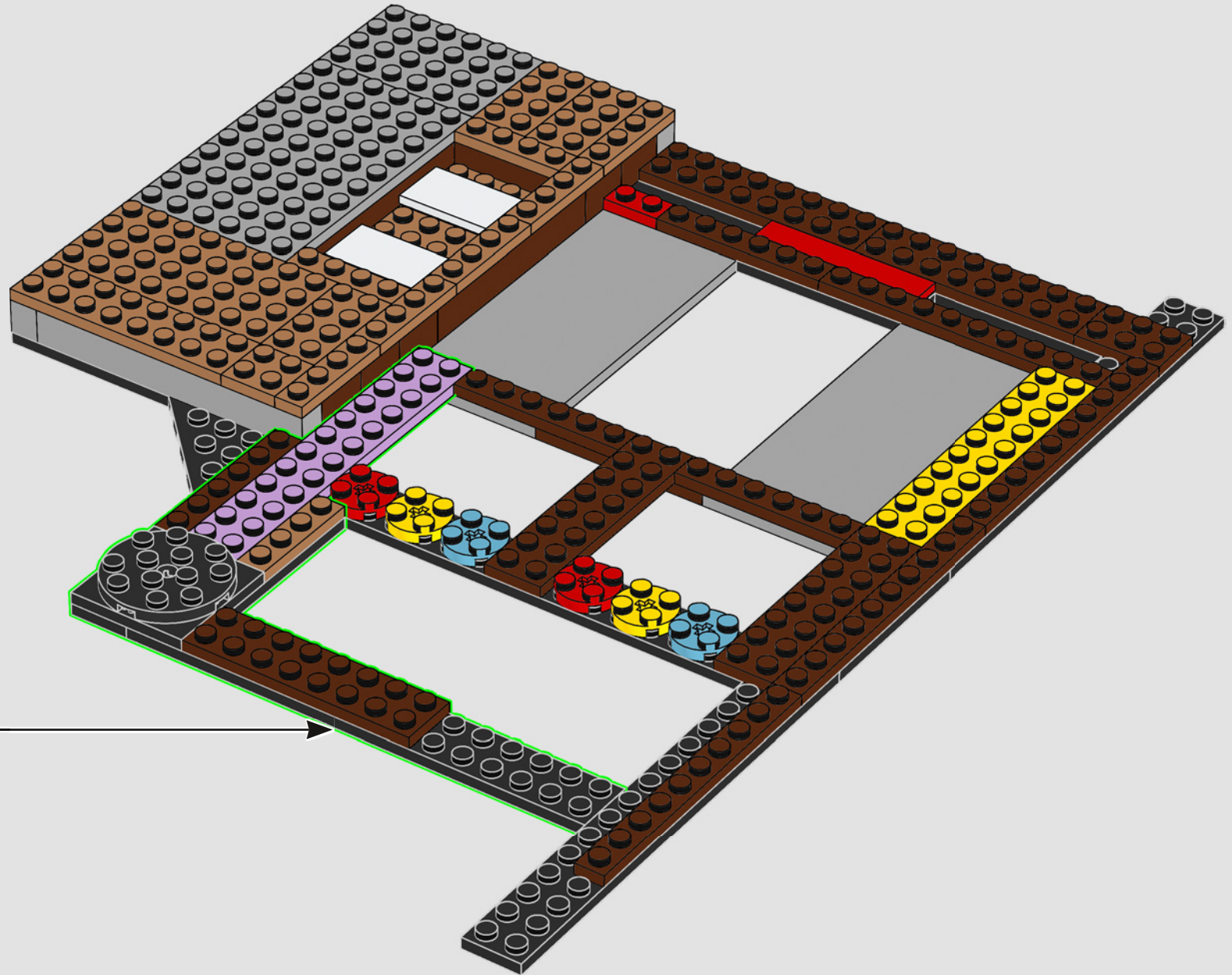

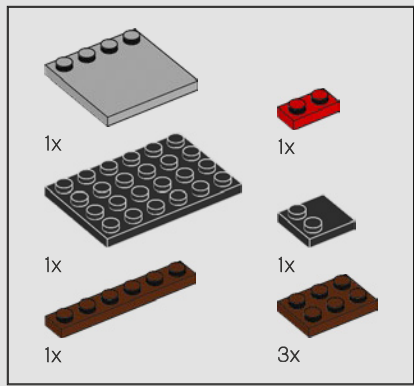

20

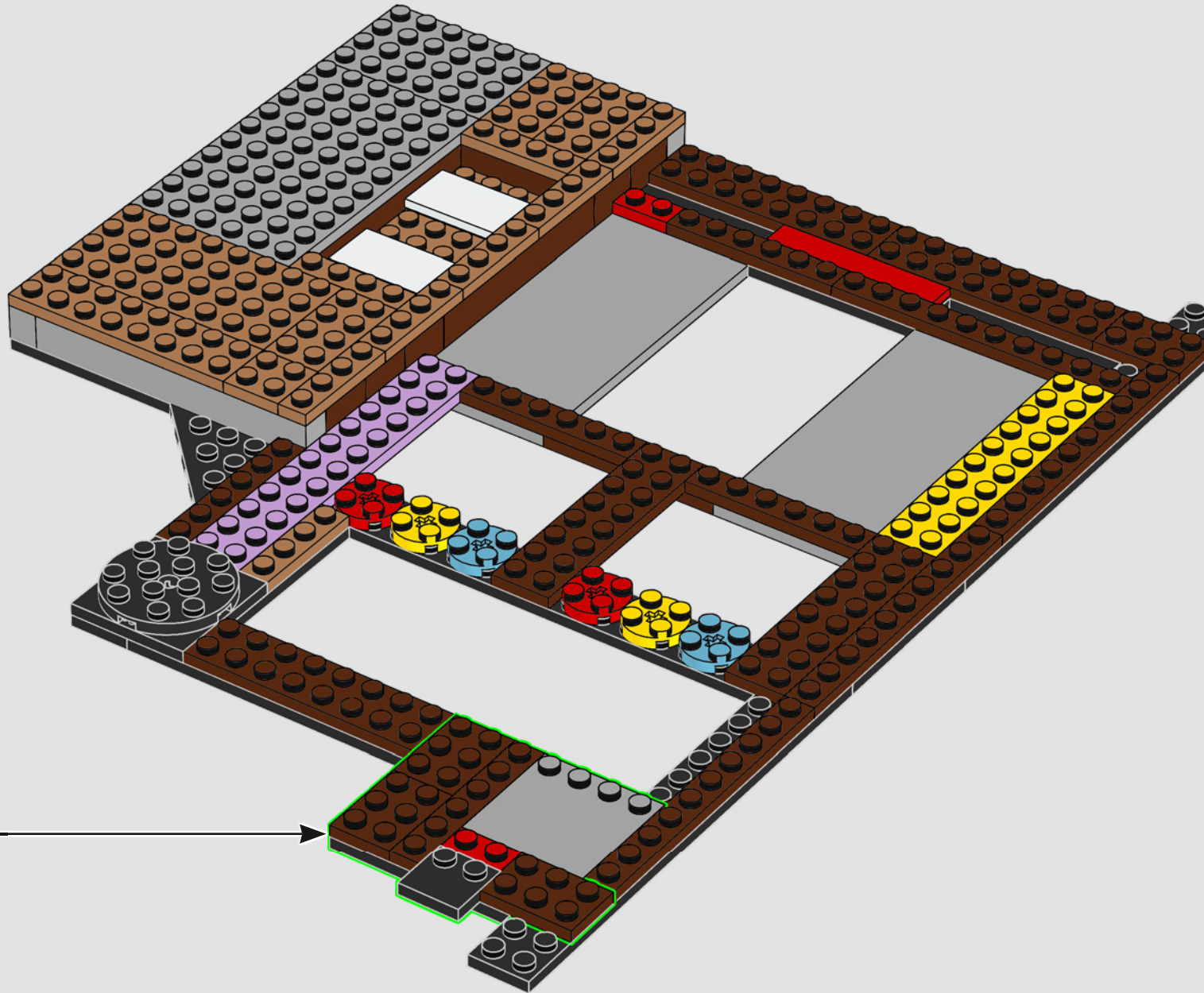
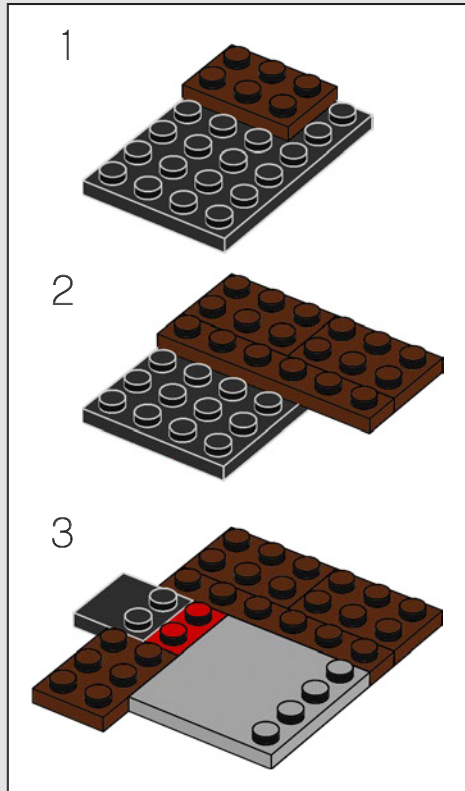

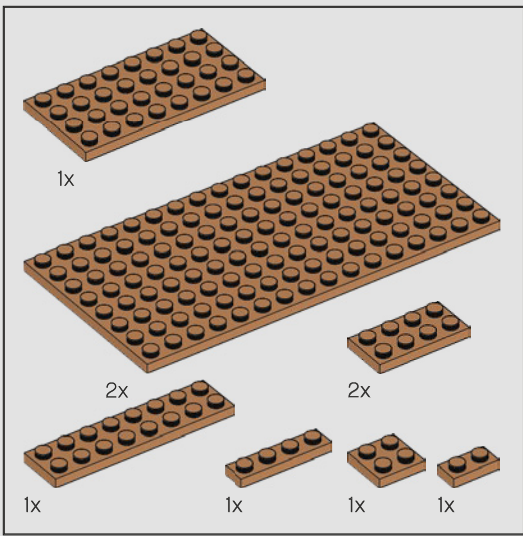

22

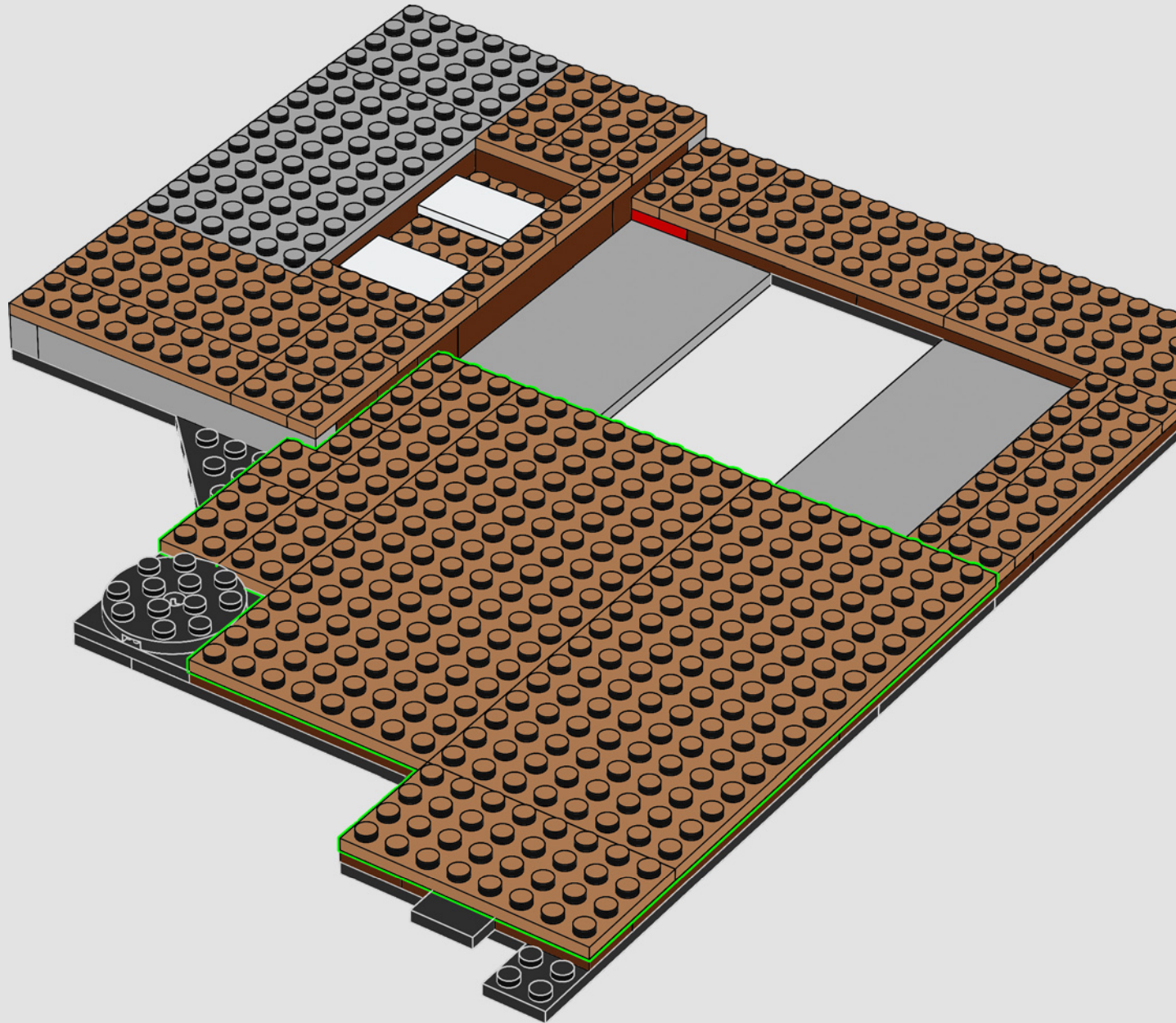

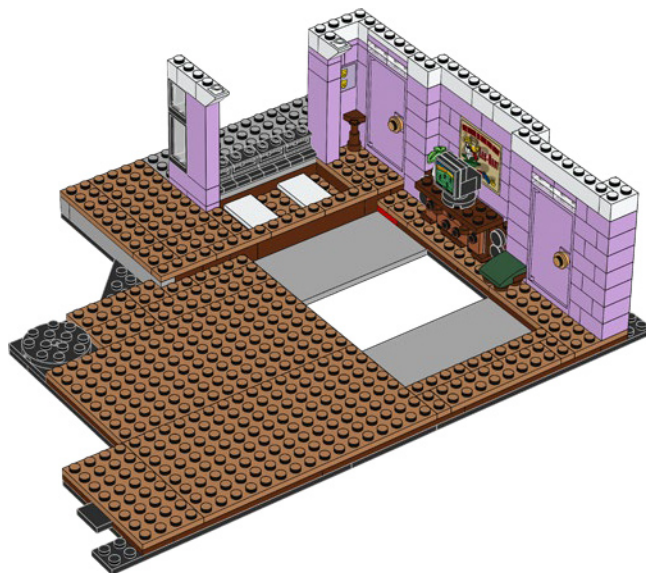



1x

23

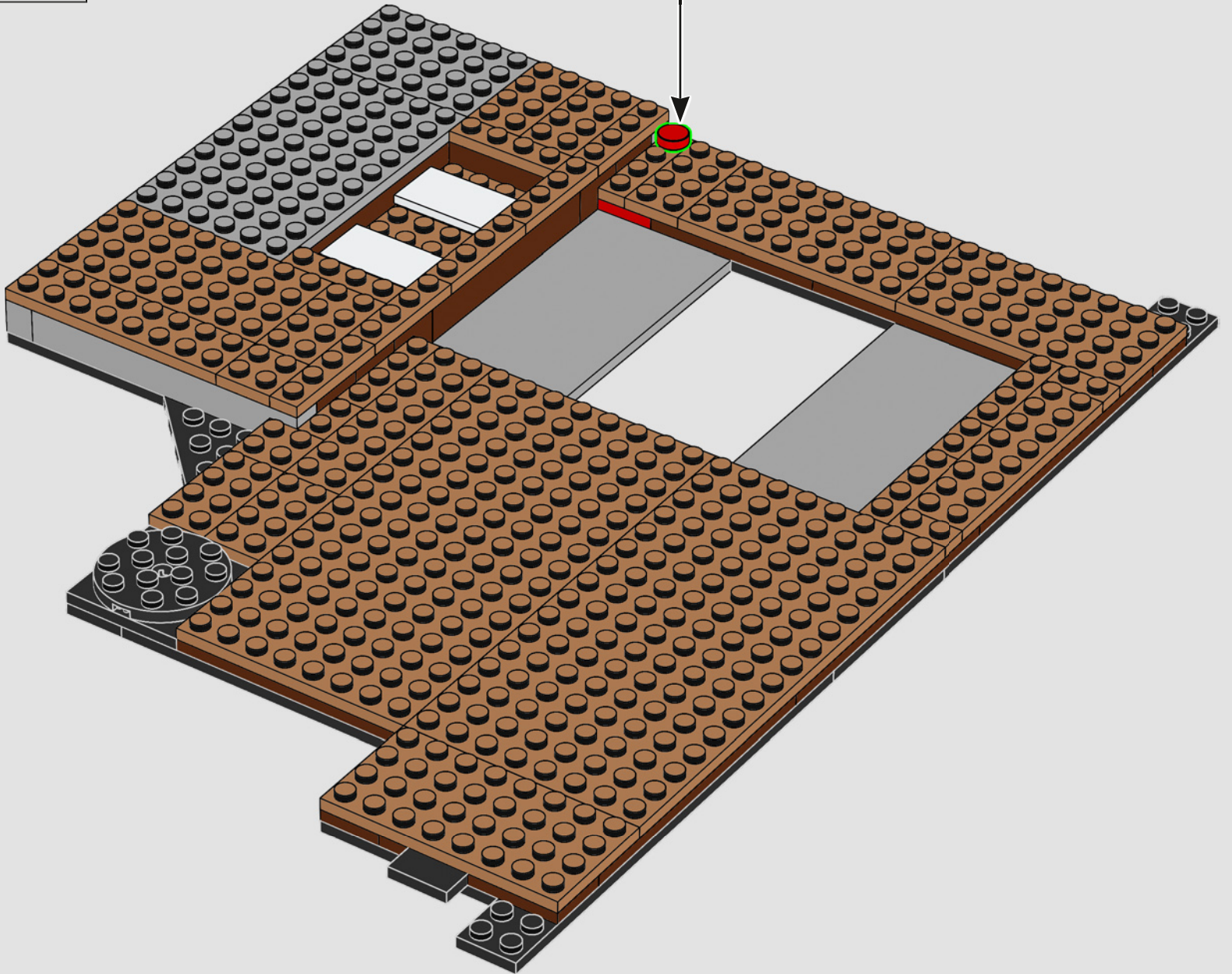

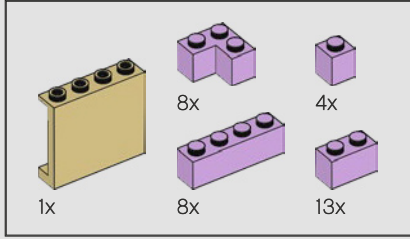
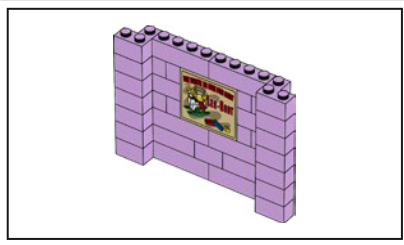

24

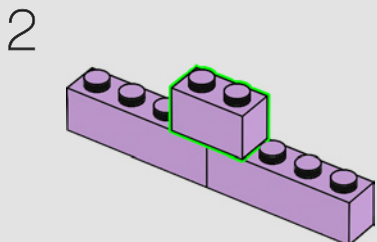
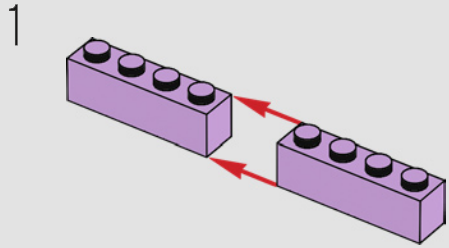

3

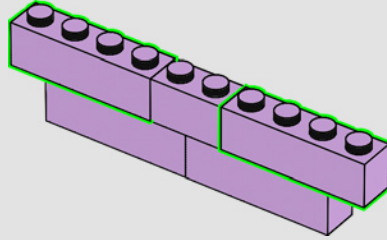

4

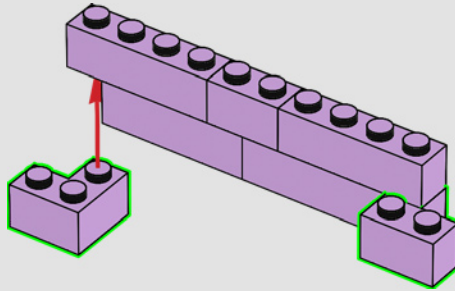

5

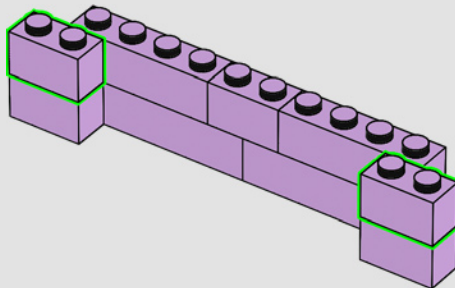

6

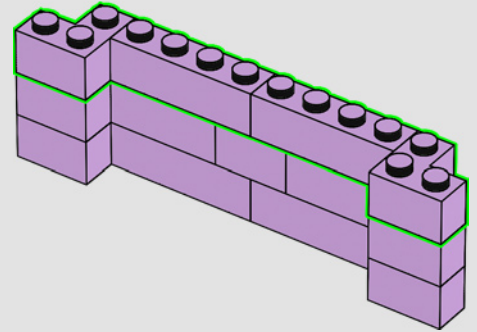

7

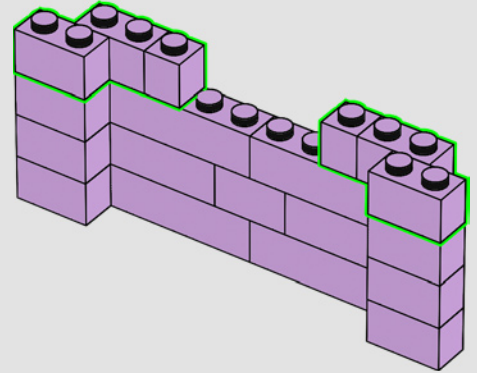

8

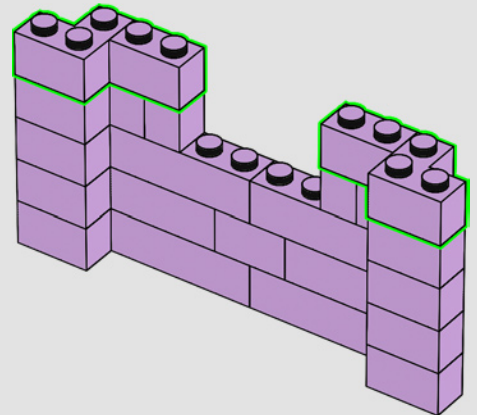

Do you remember the large poster behind the TV, and the famous golden mirror frame on the door?

Vous souvenez-vous de la grande affiche derrière la télévision, et du célèbre cadre doré sur la porte ?

¿Recuerdas el gran póster que estaba detrás del televisor, y el famoso espejo con marco dorado de la puerta?

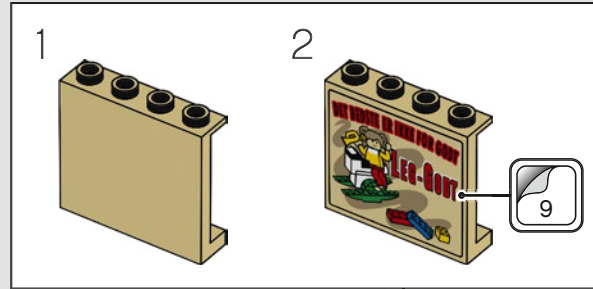

9

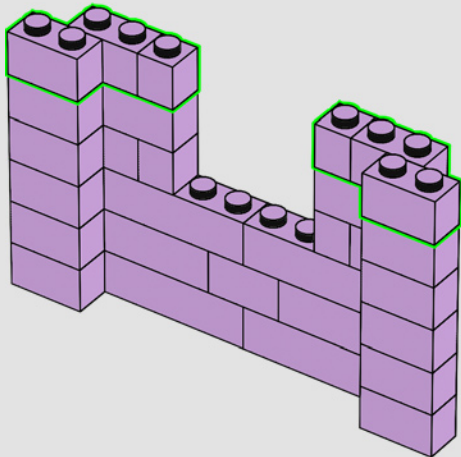

10

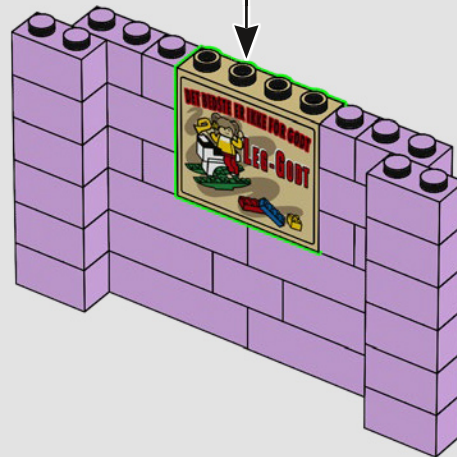

11

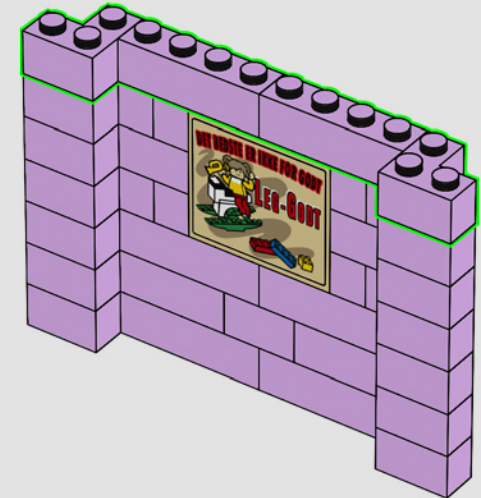

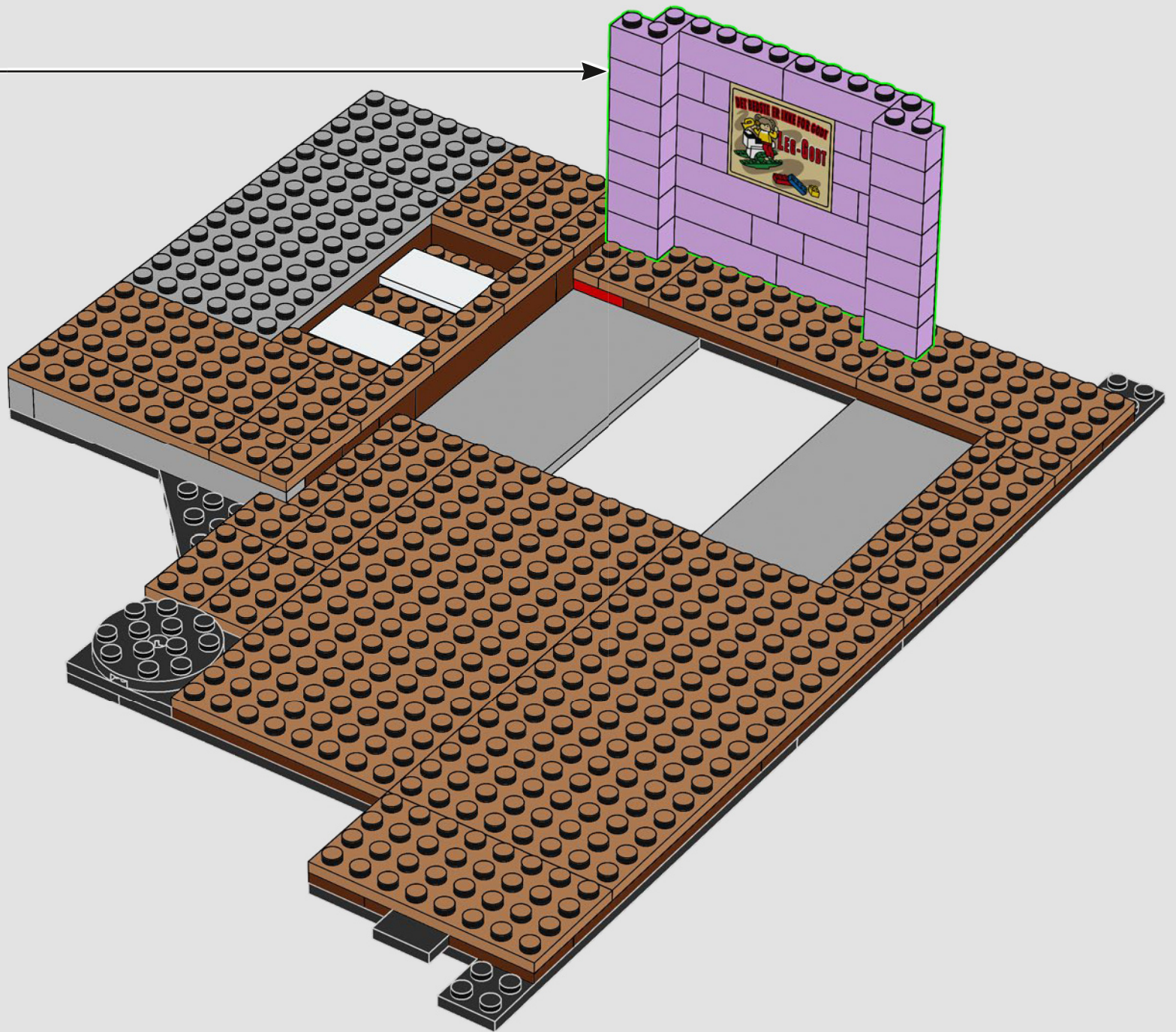

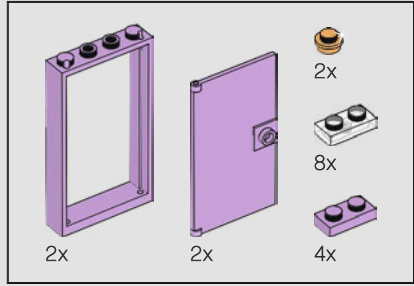

25

1

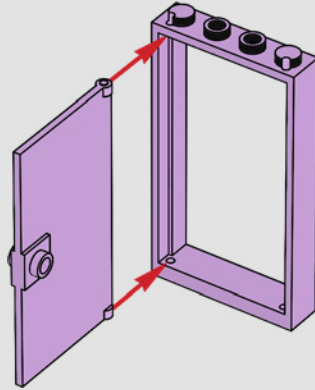

2

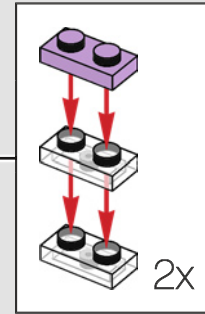
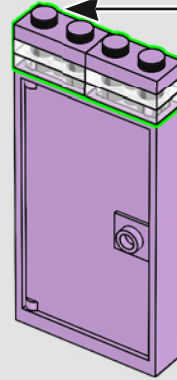

3

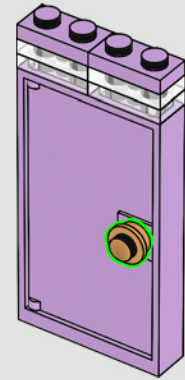

2x

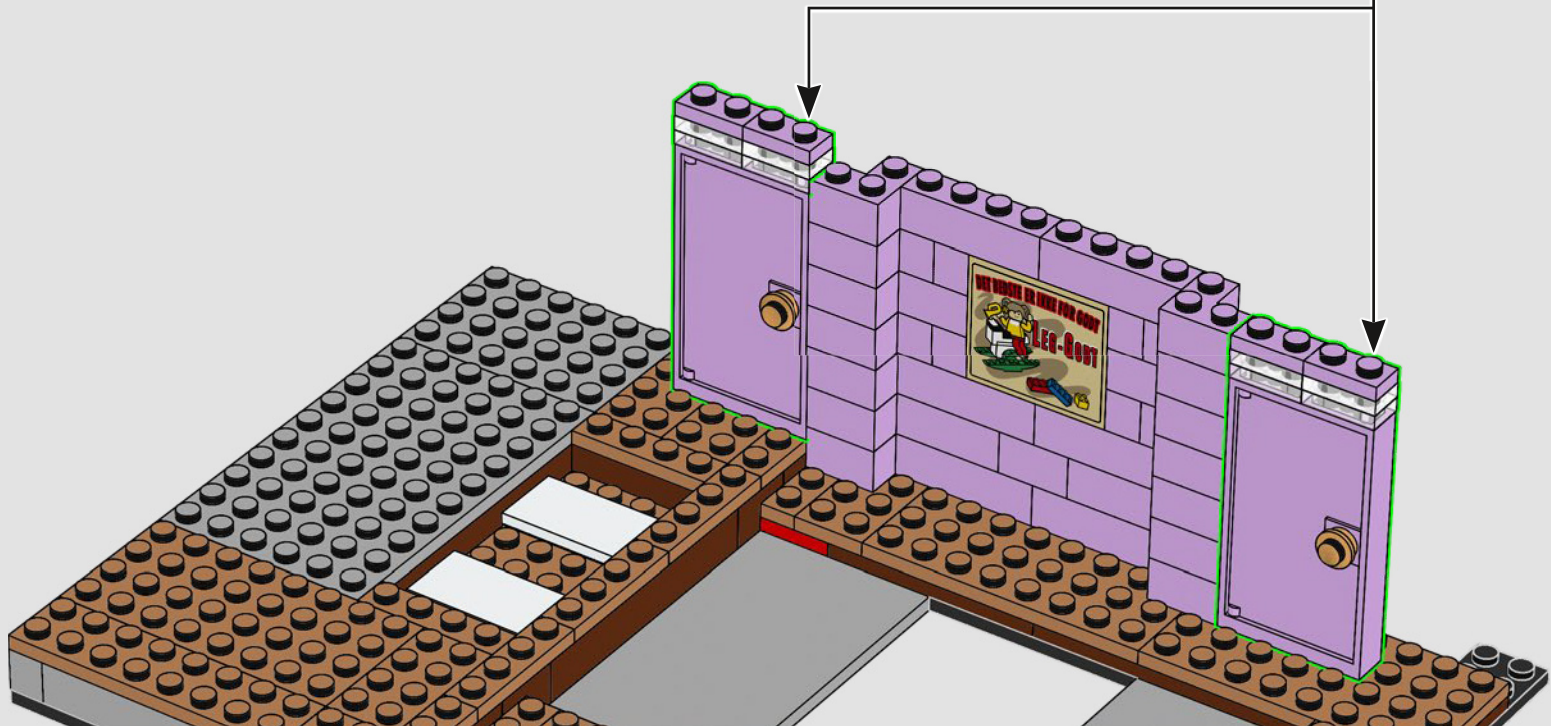

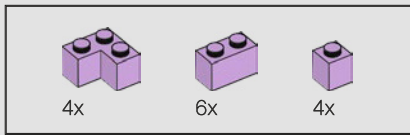

26

1

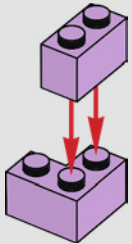

2

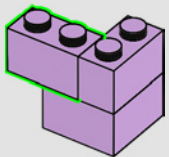

3

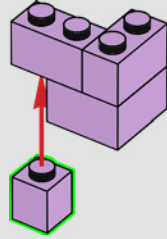

4

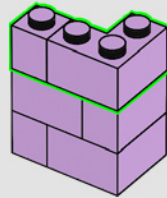

5

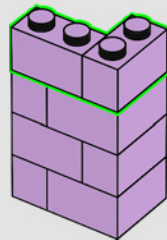

6



7

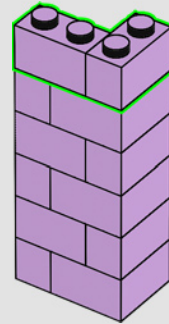

8

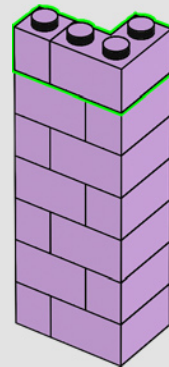

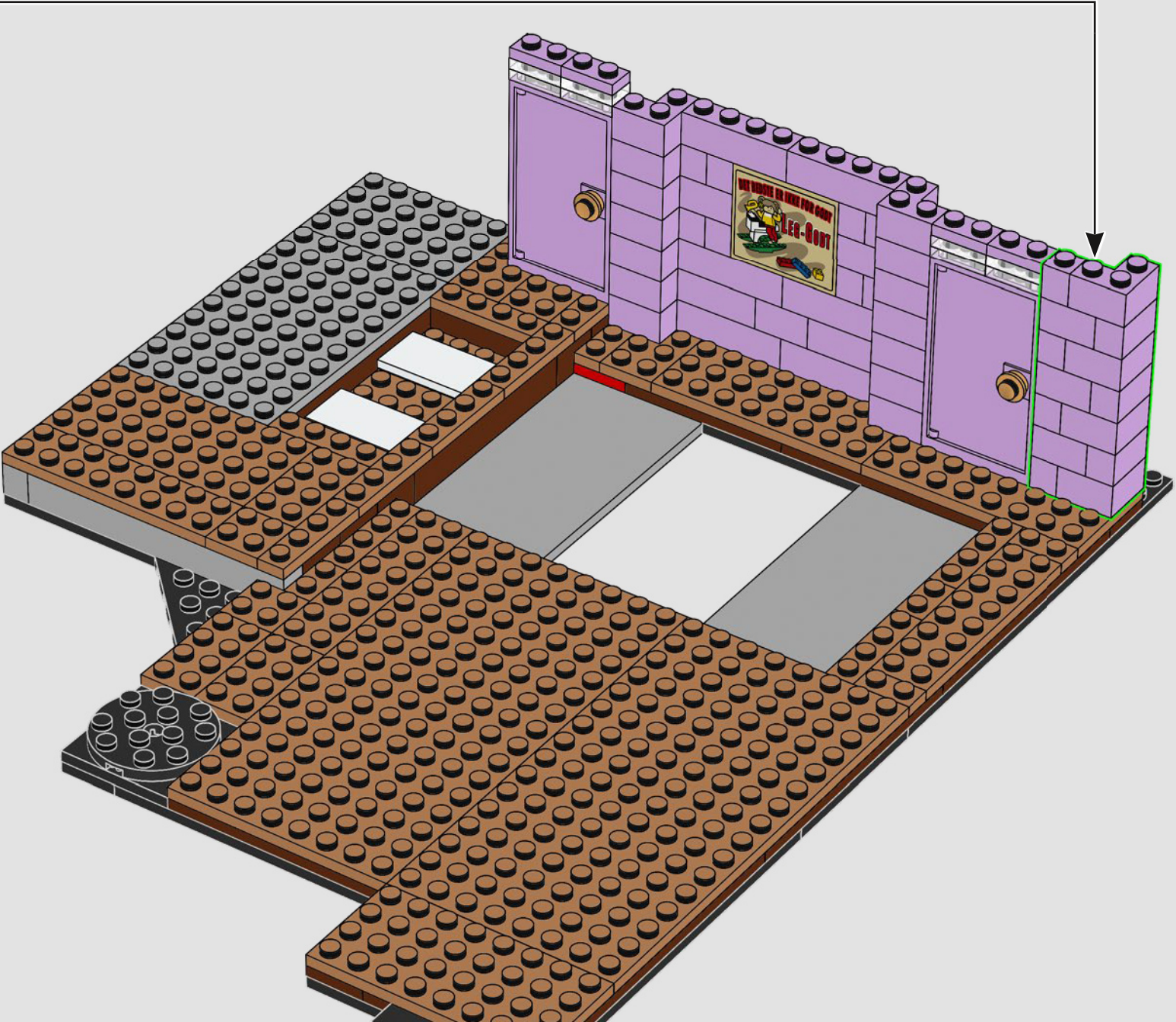

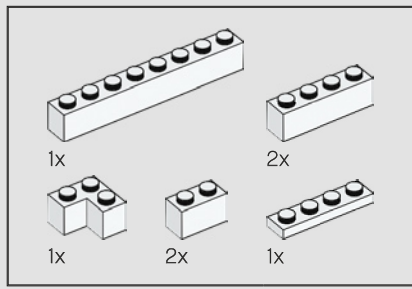

27

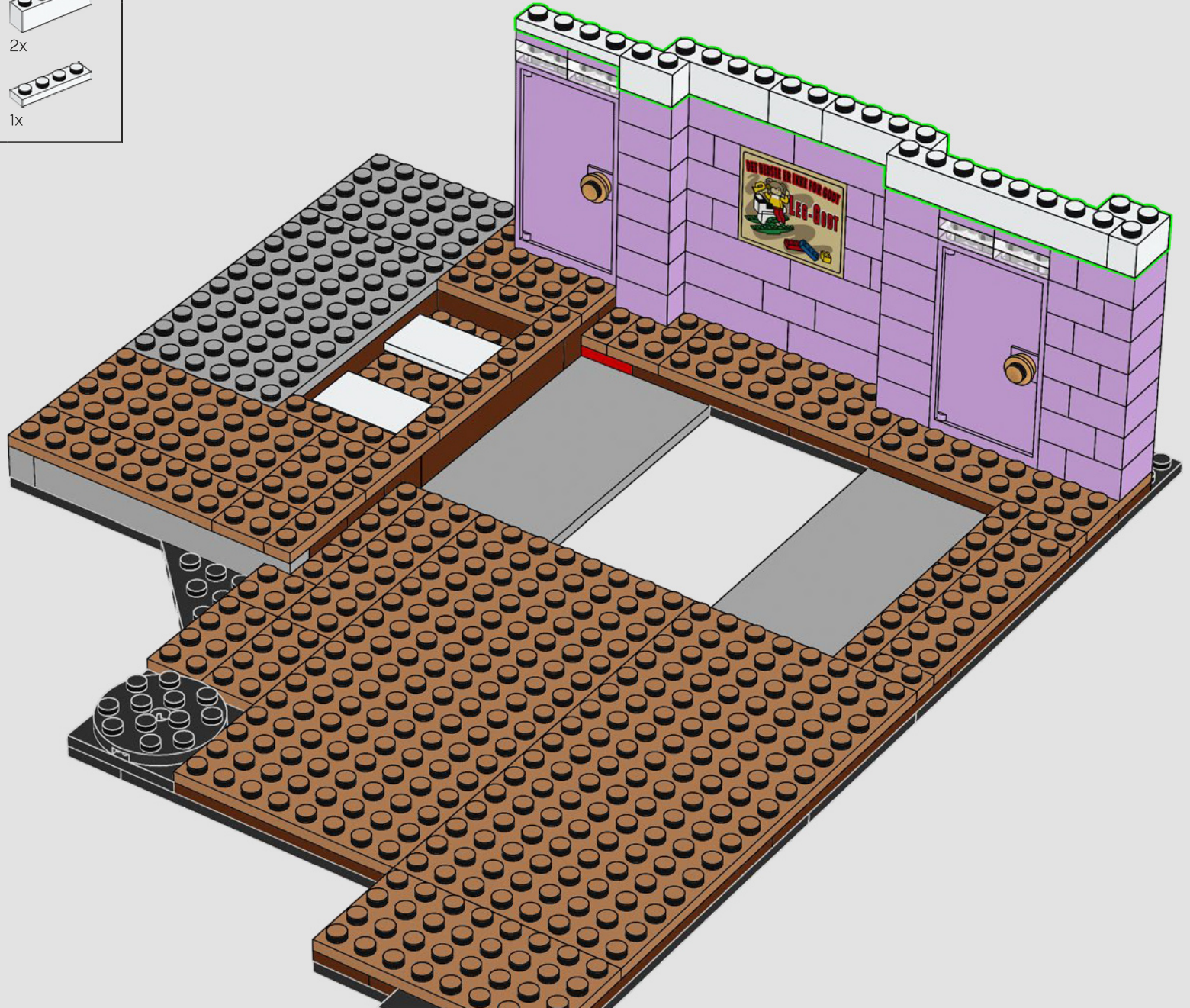

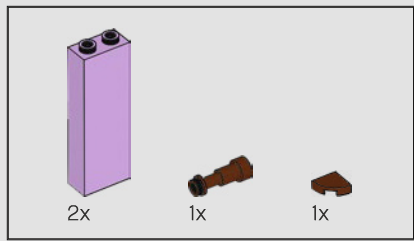

28

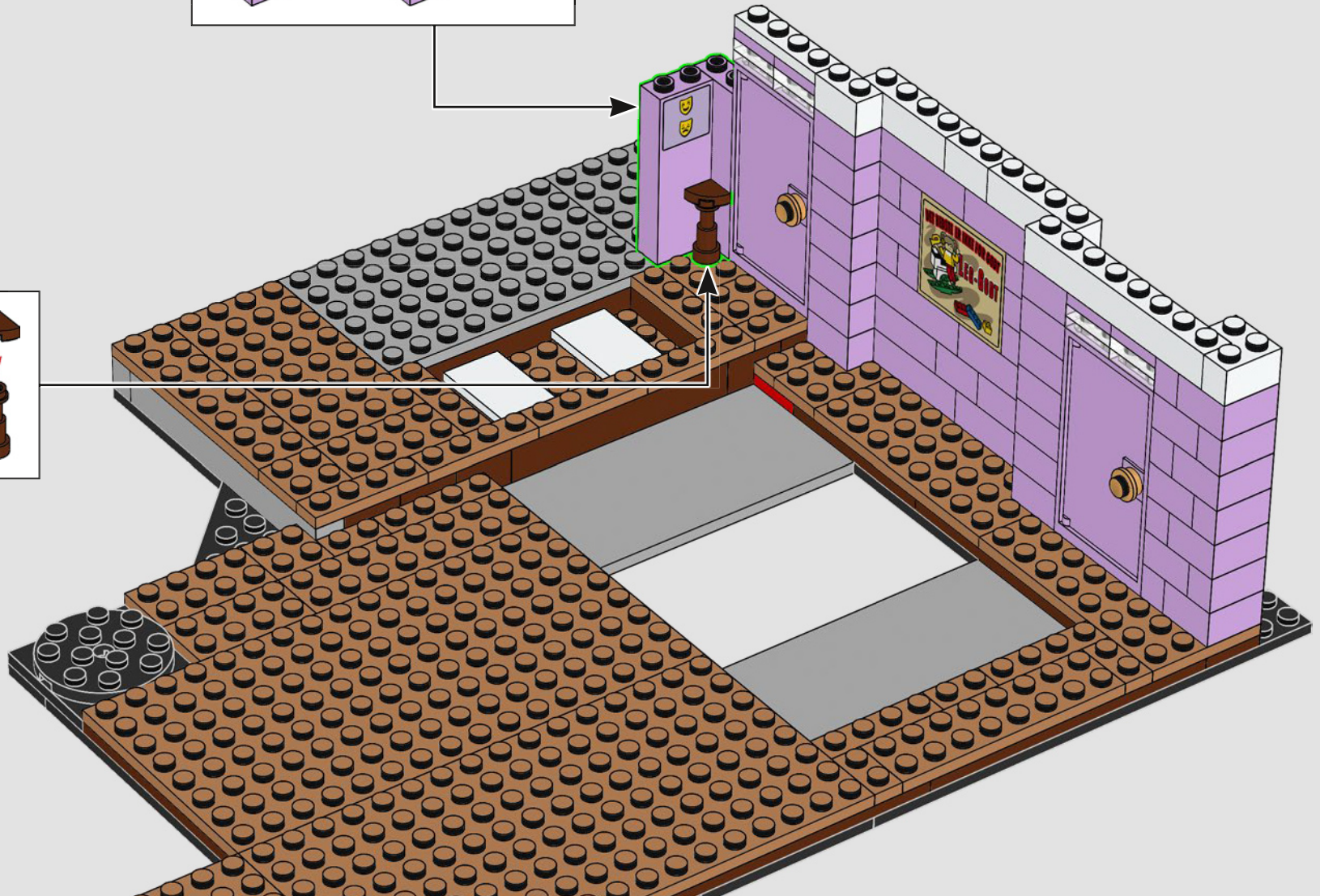
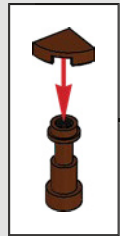
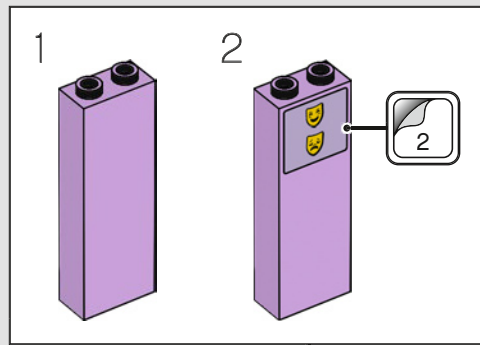

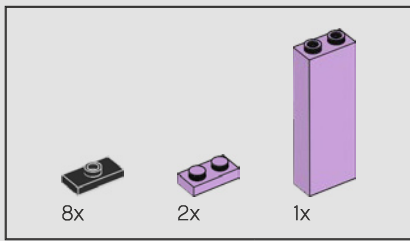

29

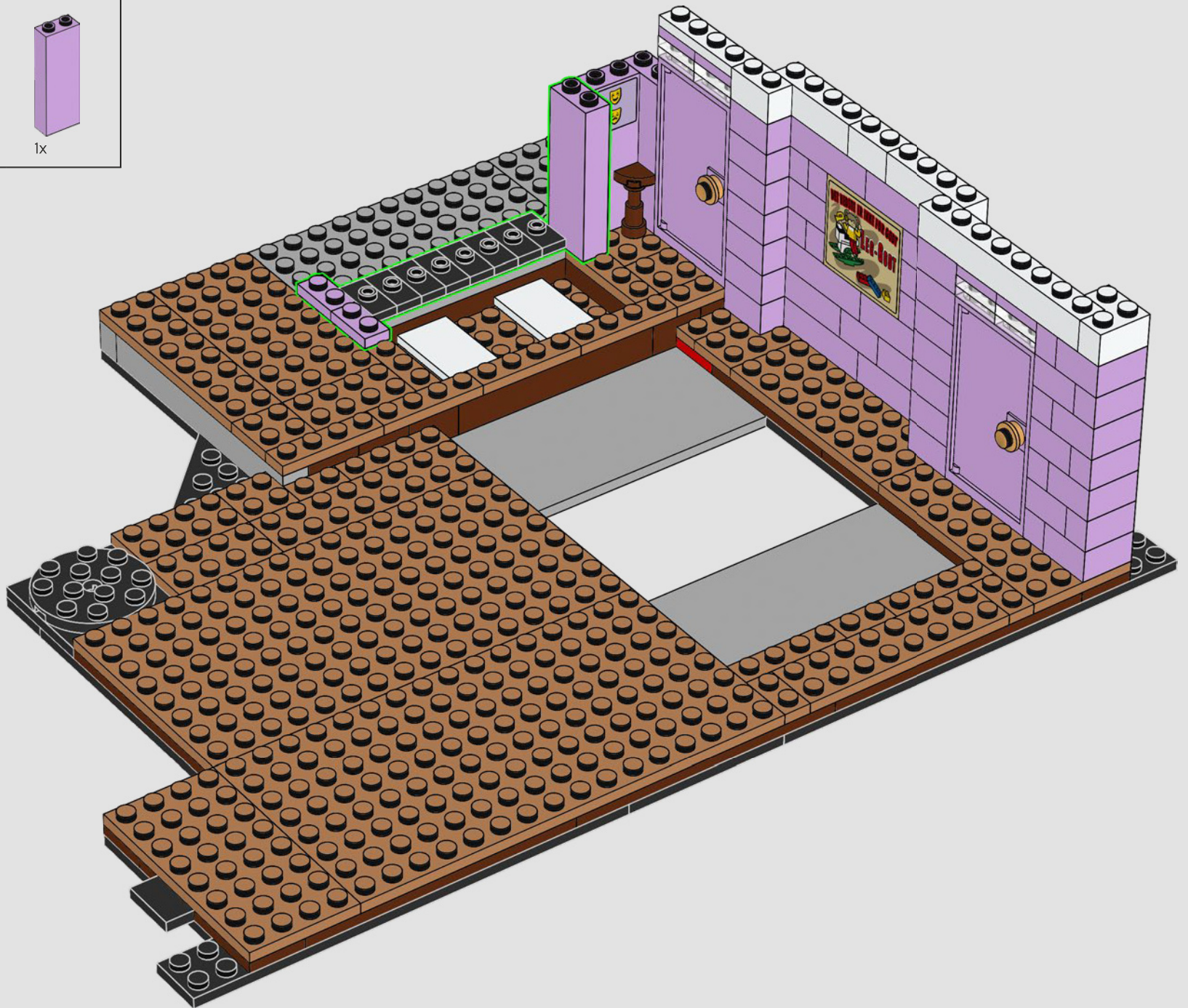

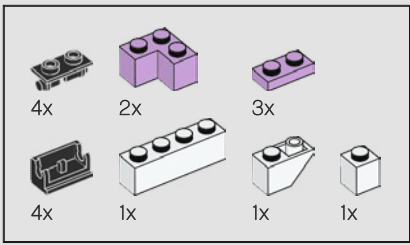

30

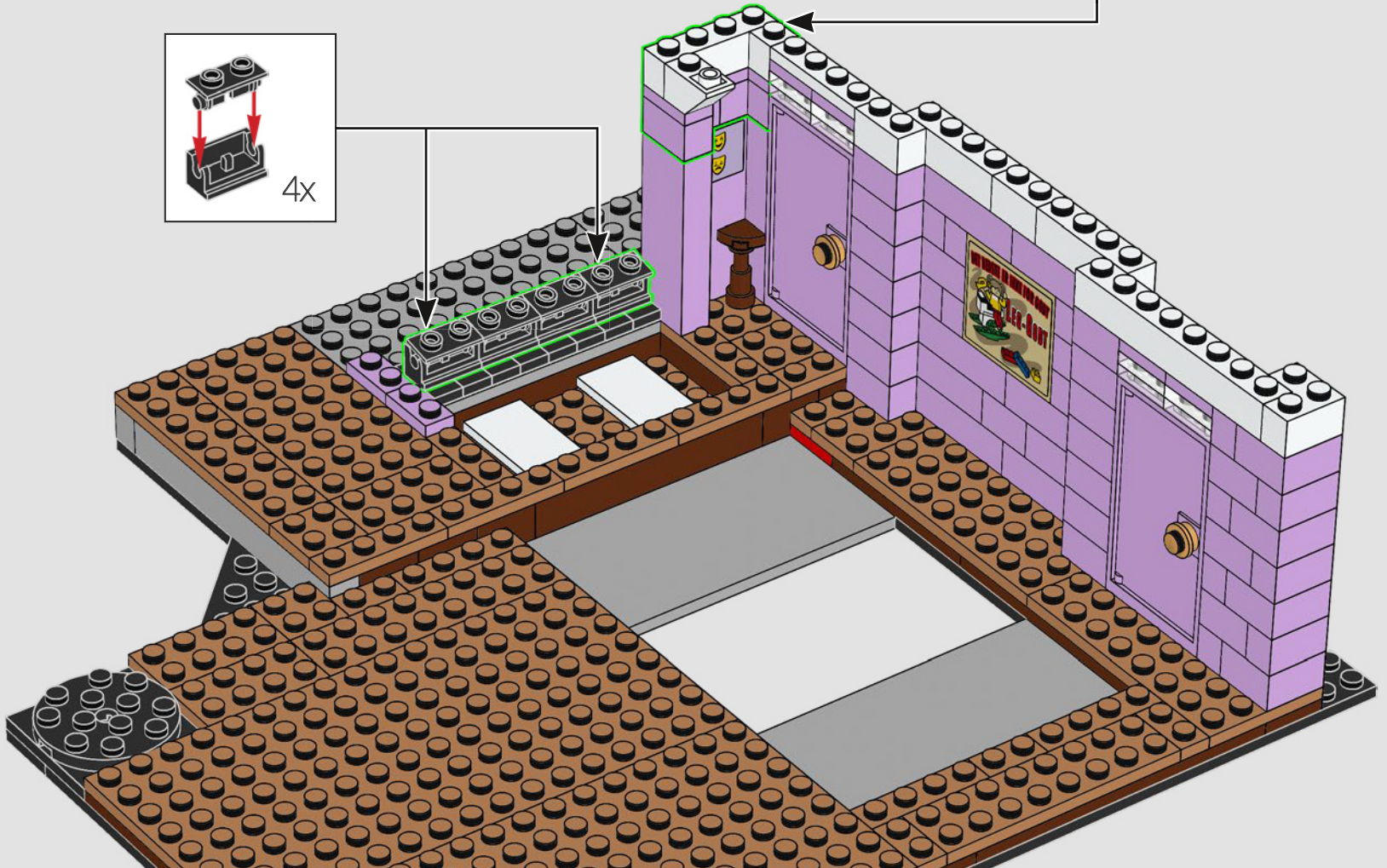
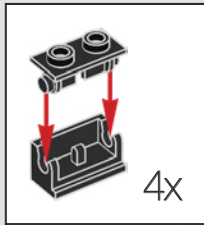
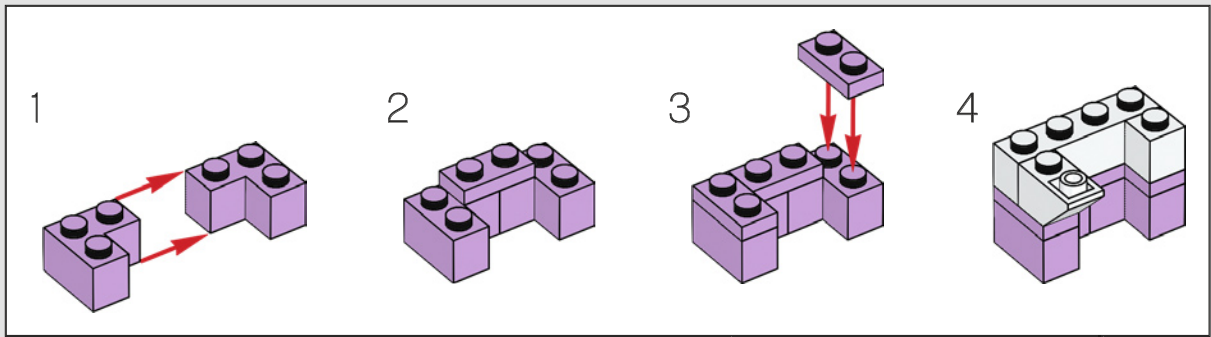

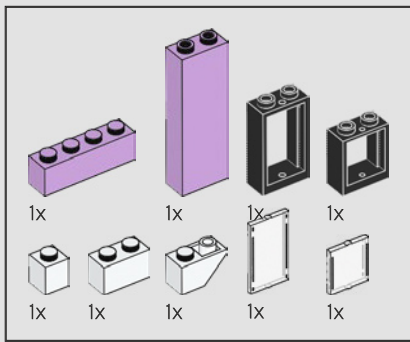

31

1

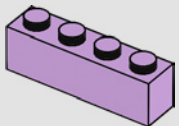

2

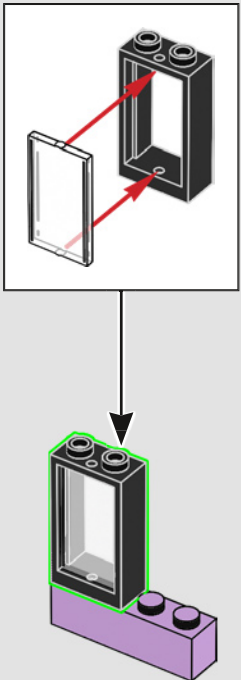

3

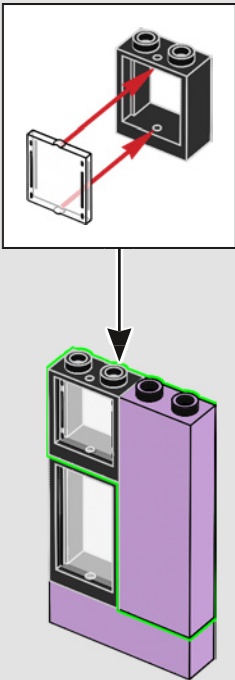

4

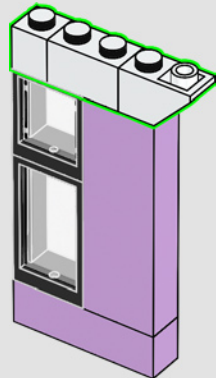

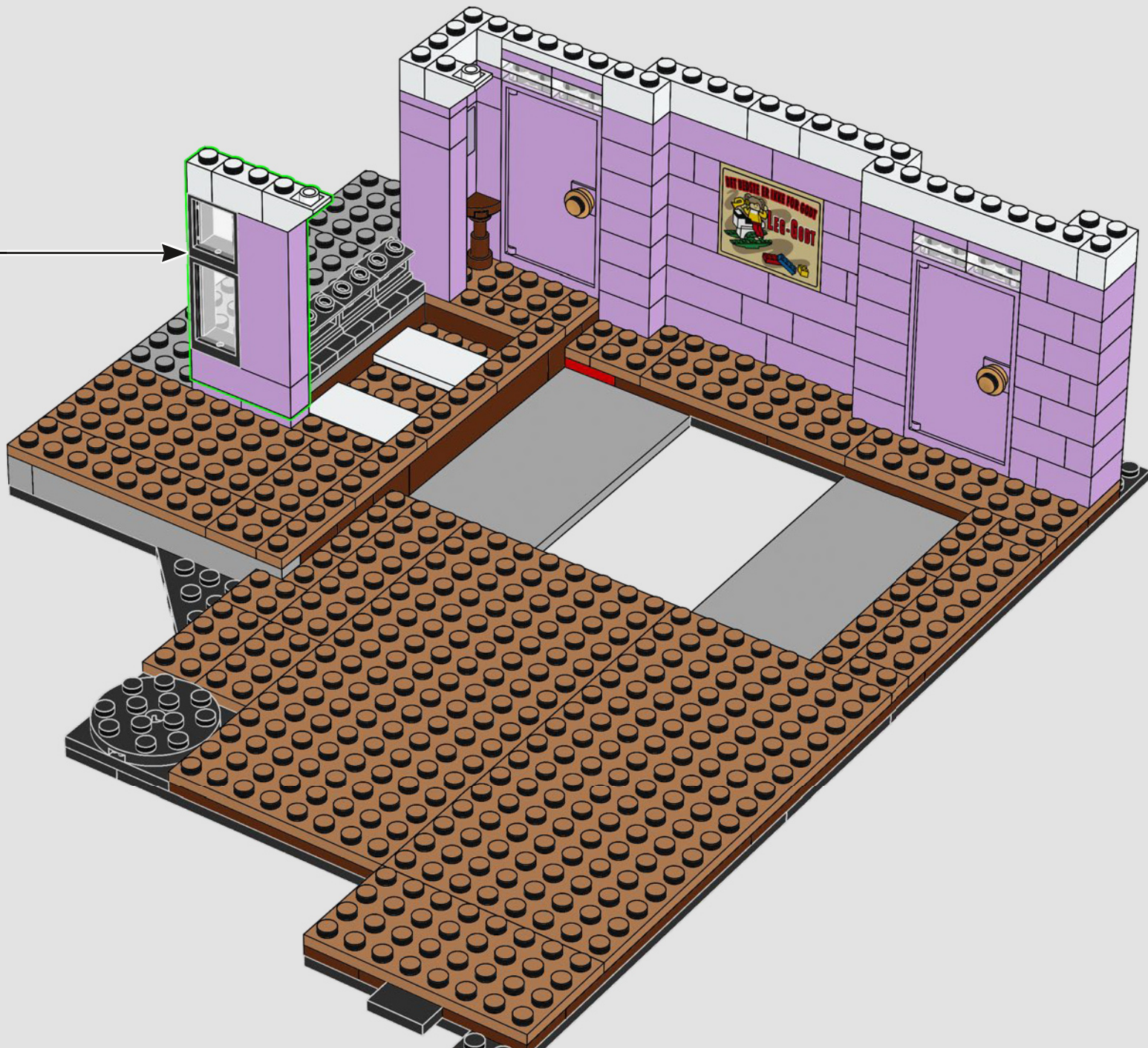

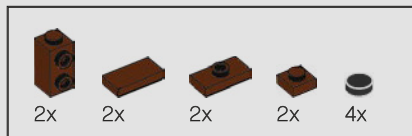

32

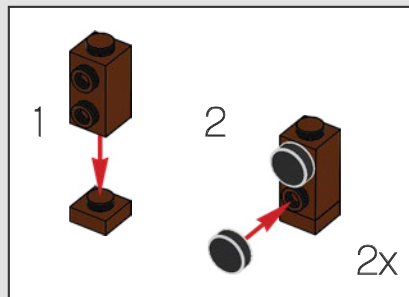

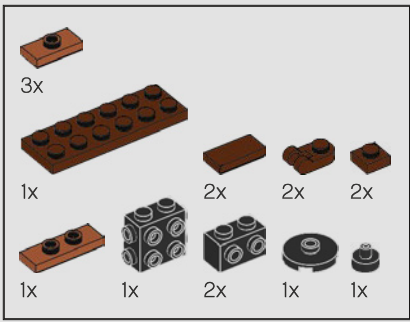

33

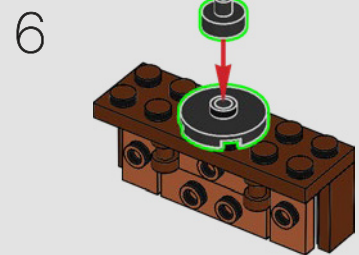
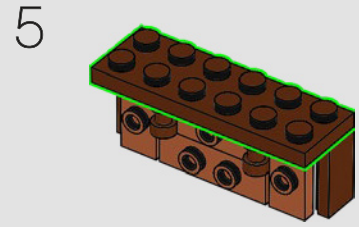
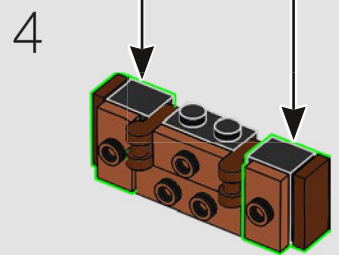
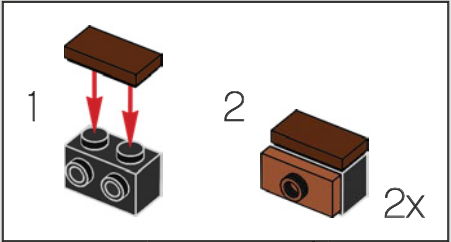
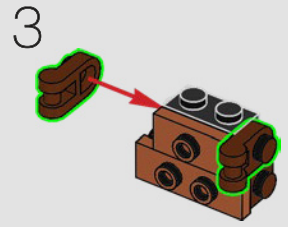
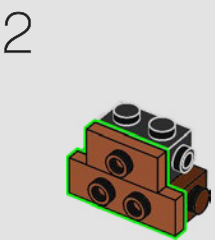
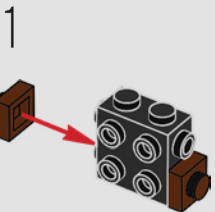



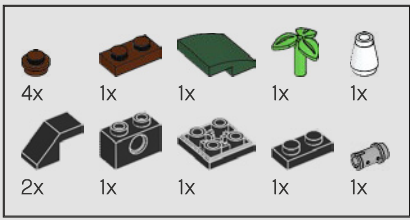

34

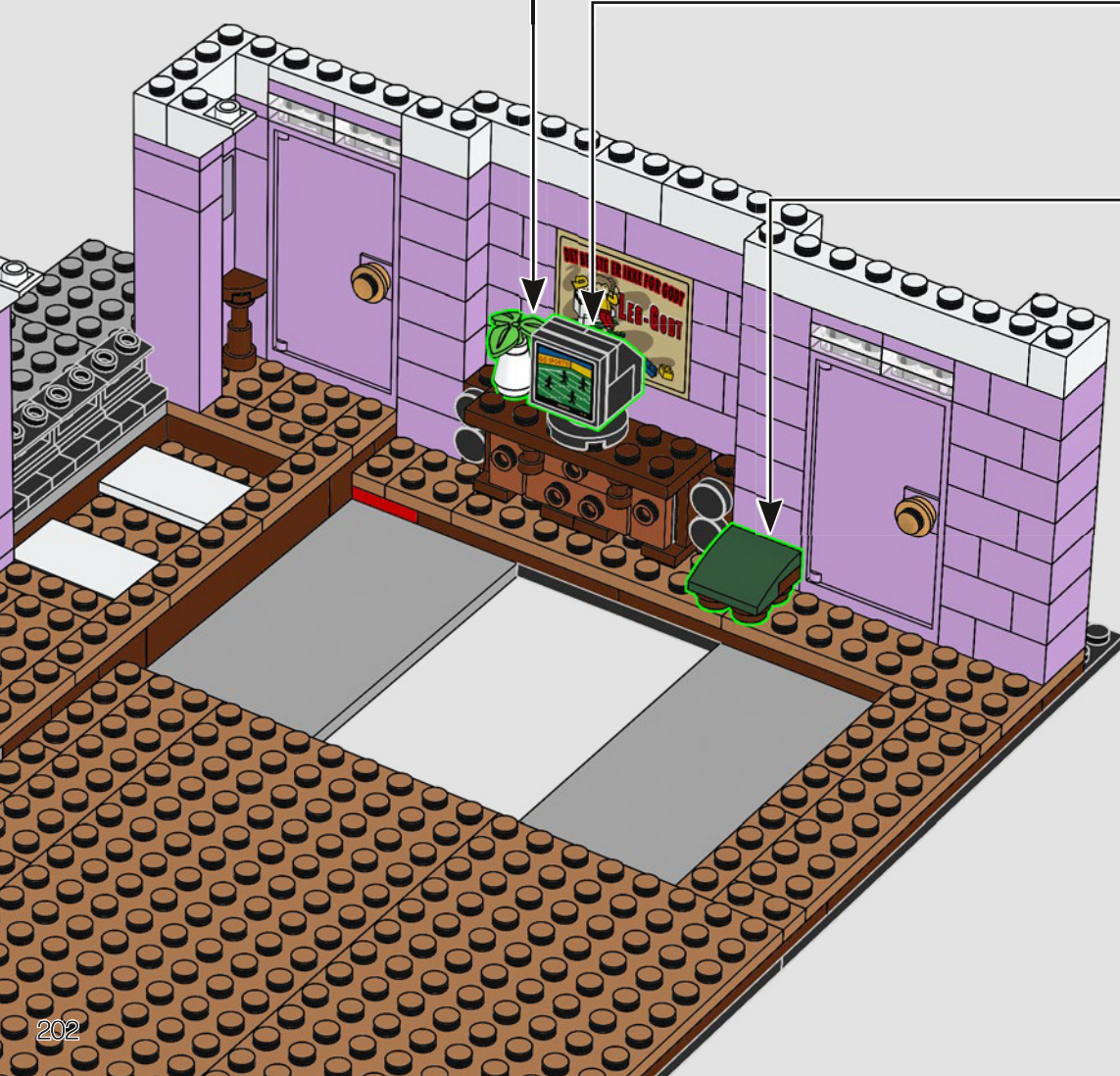
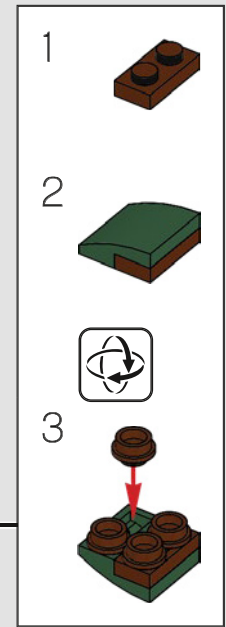
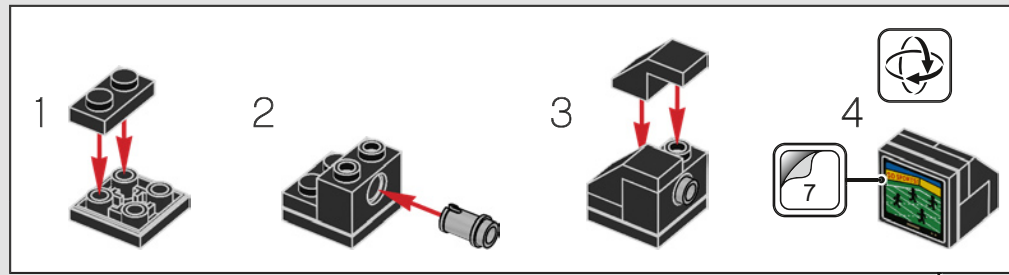
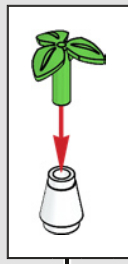

● The gang watched football on this TV during Thanksgiving to avoid helping Monica cook.

● Les amis ont regardé le football sur cette télé durant l'Action de grâce pour éviter de devoir aider Monica dans la cuisine.

● Todos decidieron ver un partido de futbol americano en este televisor el Día de Acción de Gracias para evitar ayudarlo a cocinar a Monica.

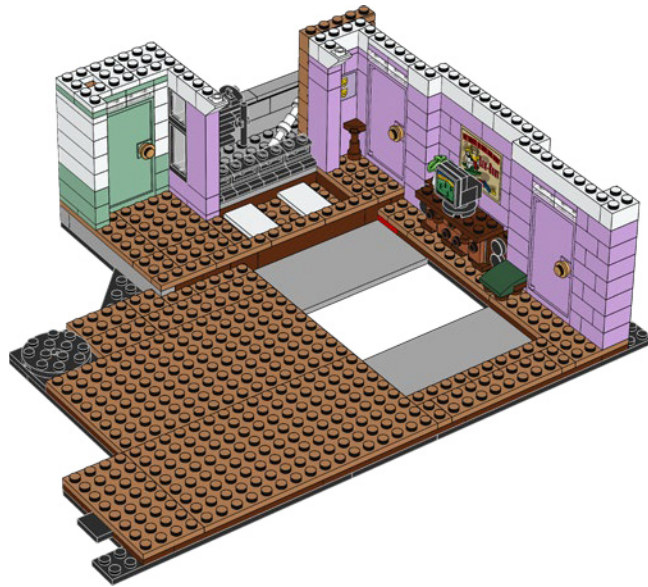

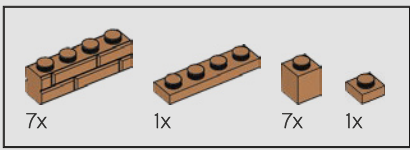

35

1

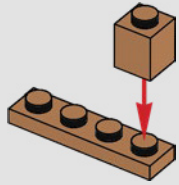

2

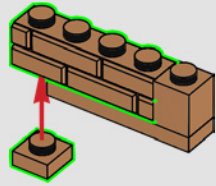

3

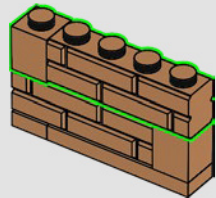

4

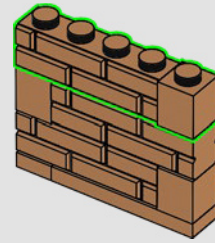

5

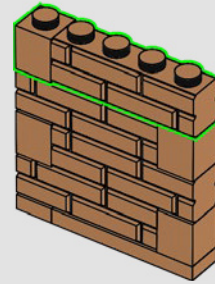

6

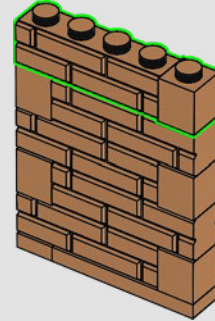

7

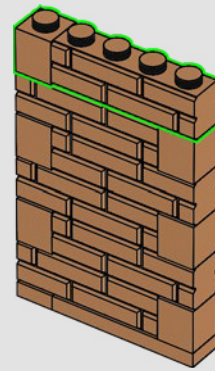

8

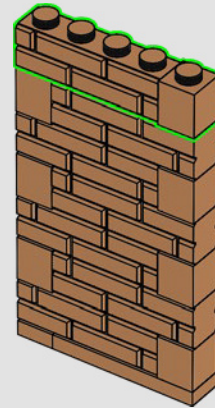

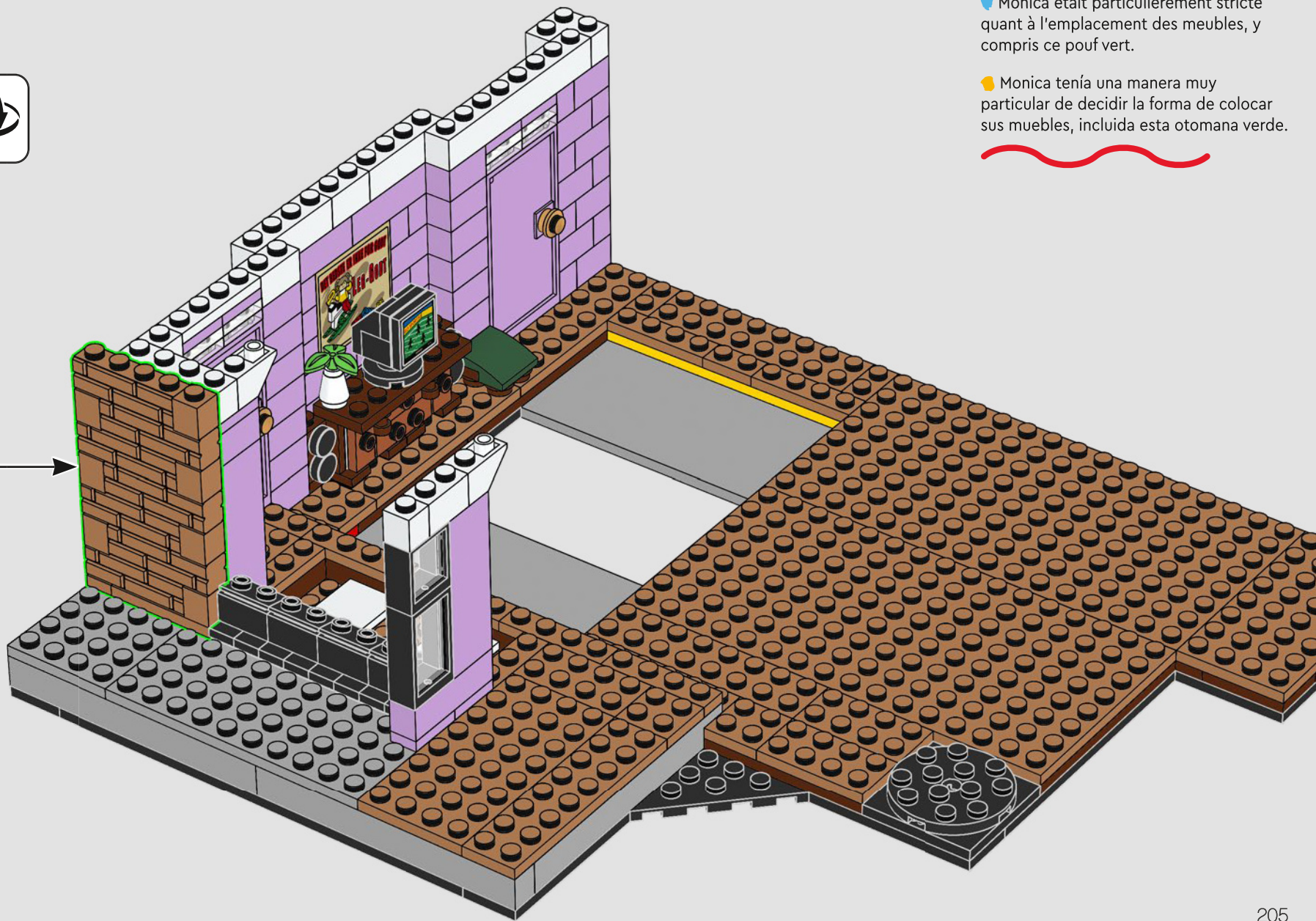

■ Monica was very particular about the placement of her furniture, including this green ottoman.

■ Monica était particulièrement stricte quant à l'emplacement des meubles, y compris ce pouf vert.

■ Monica tenía una manera muy particular de decidir la forma de colocar sus muebles, incluida esta otomana verde.



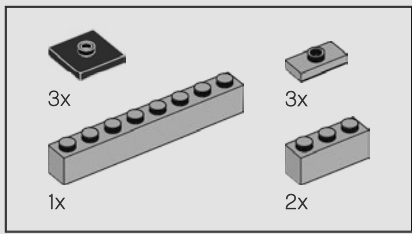

36

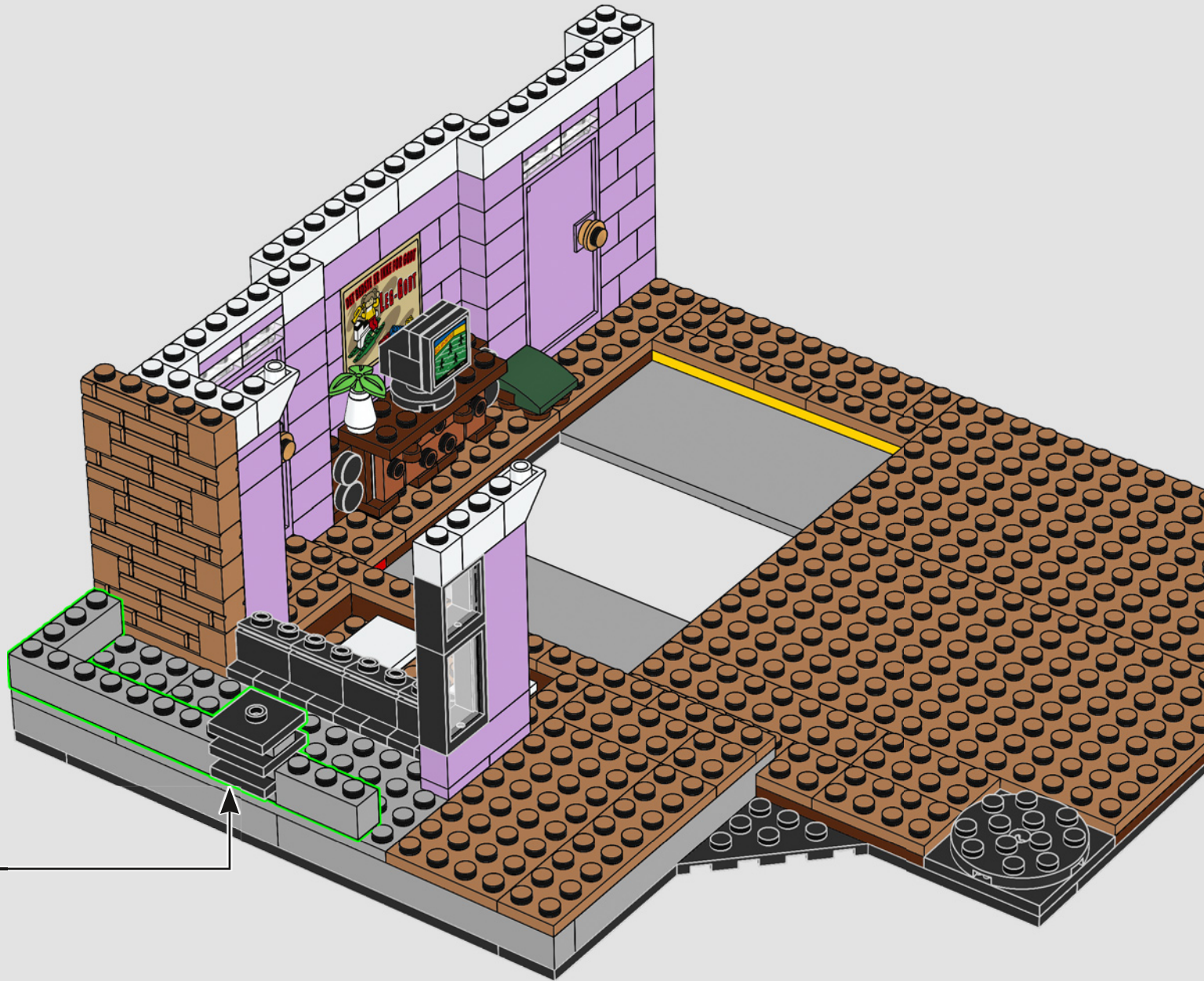
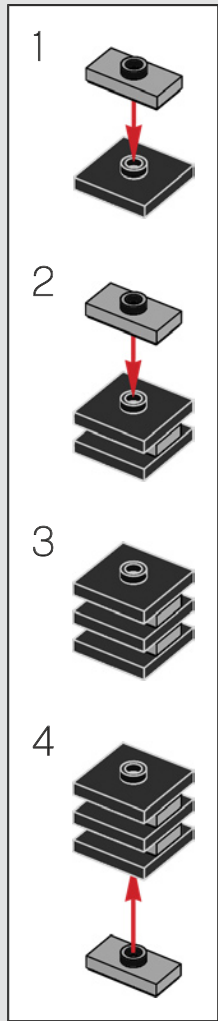

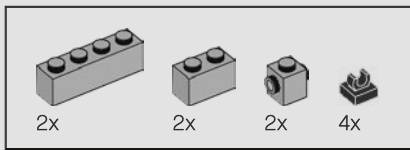

37

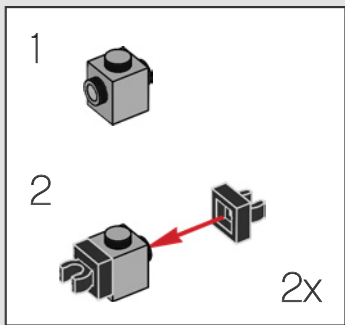
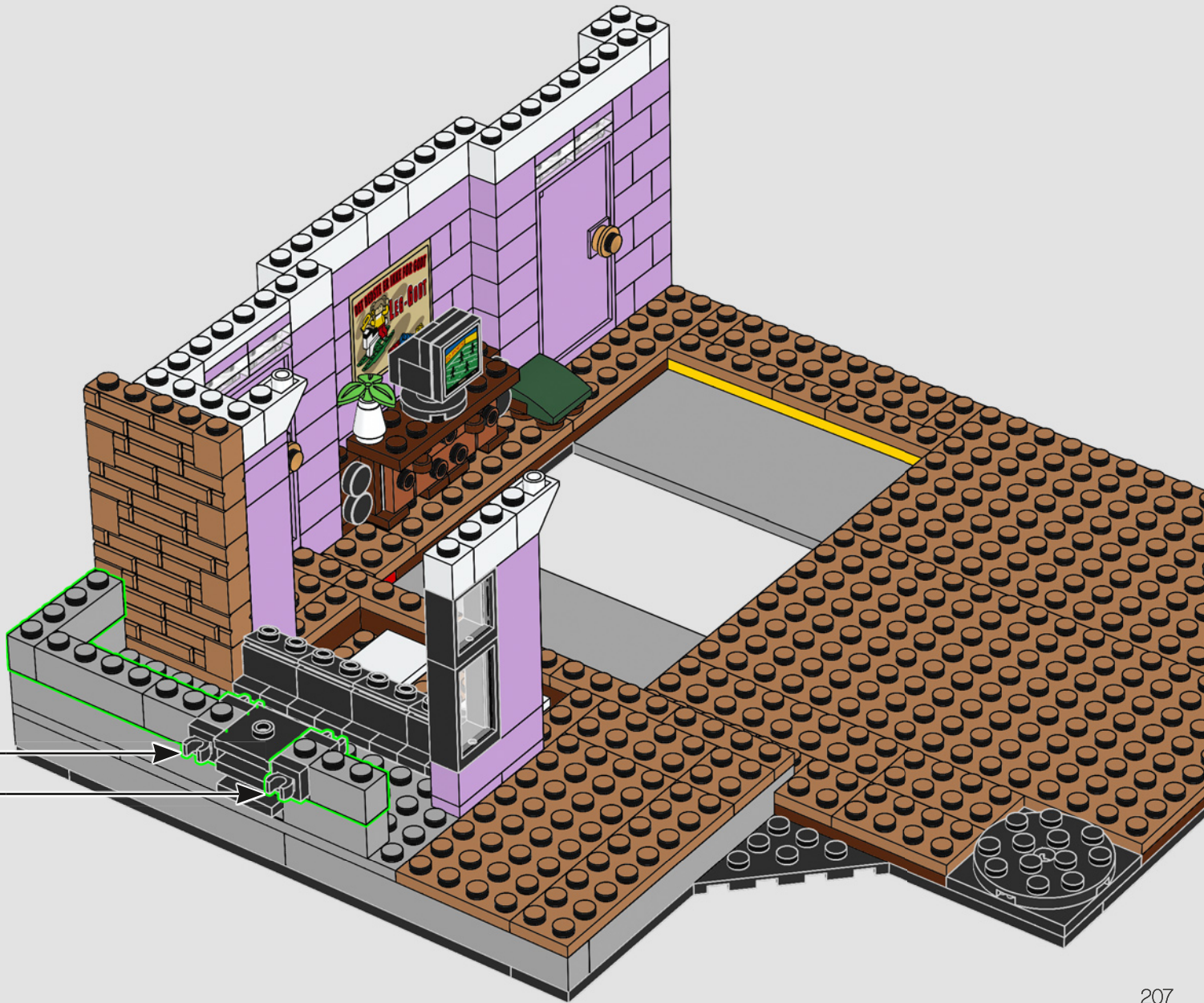

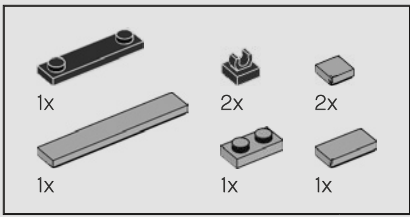

38

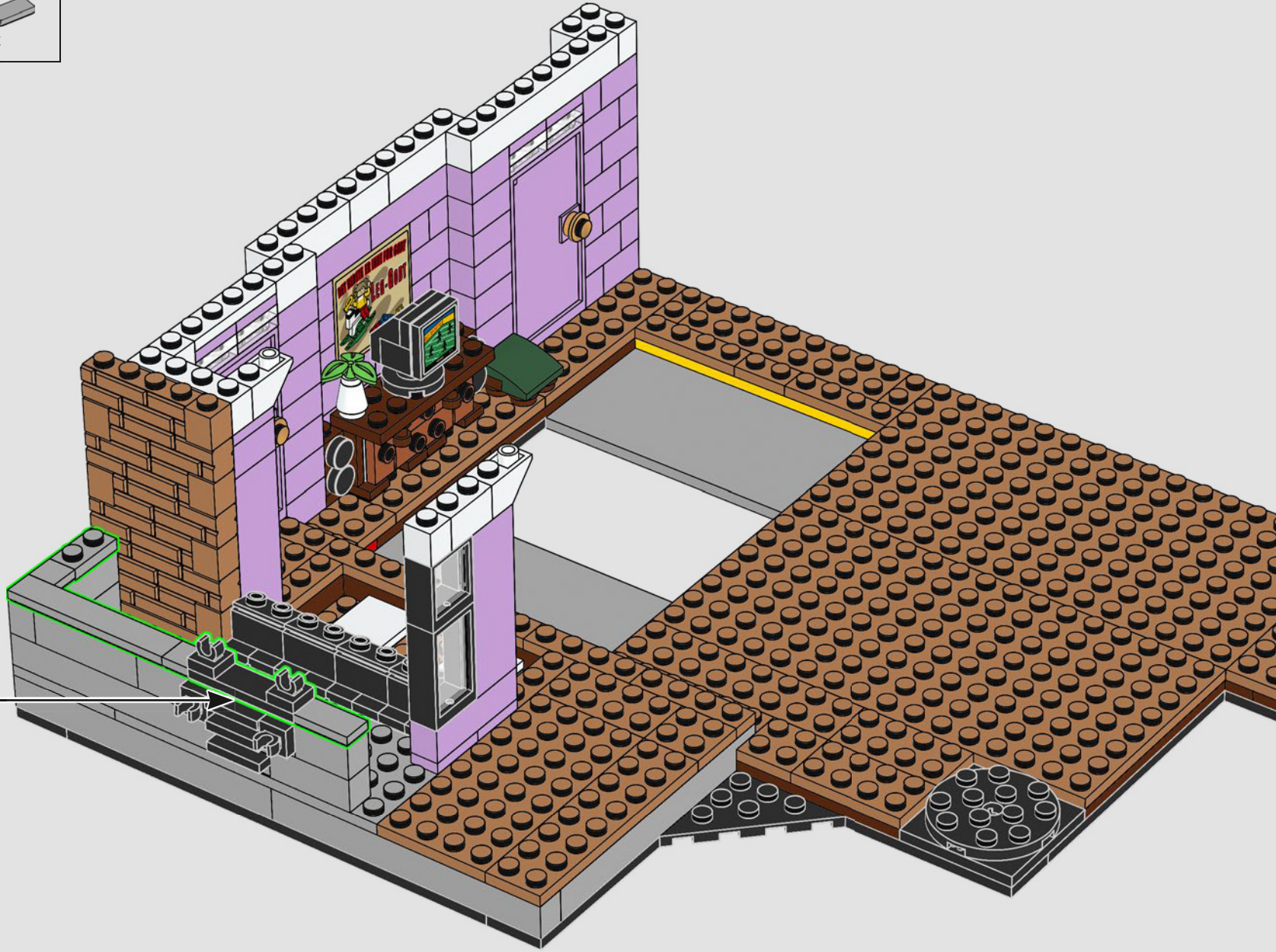
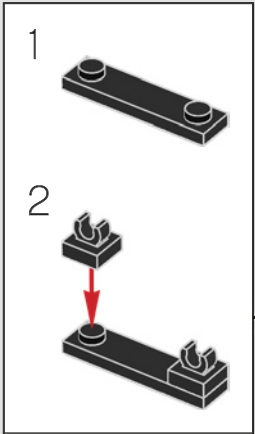



39

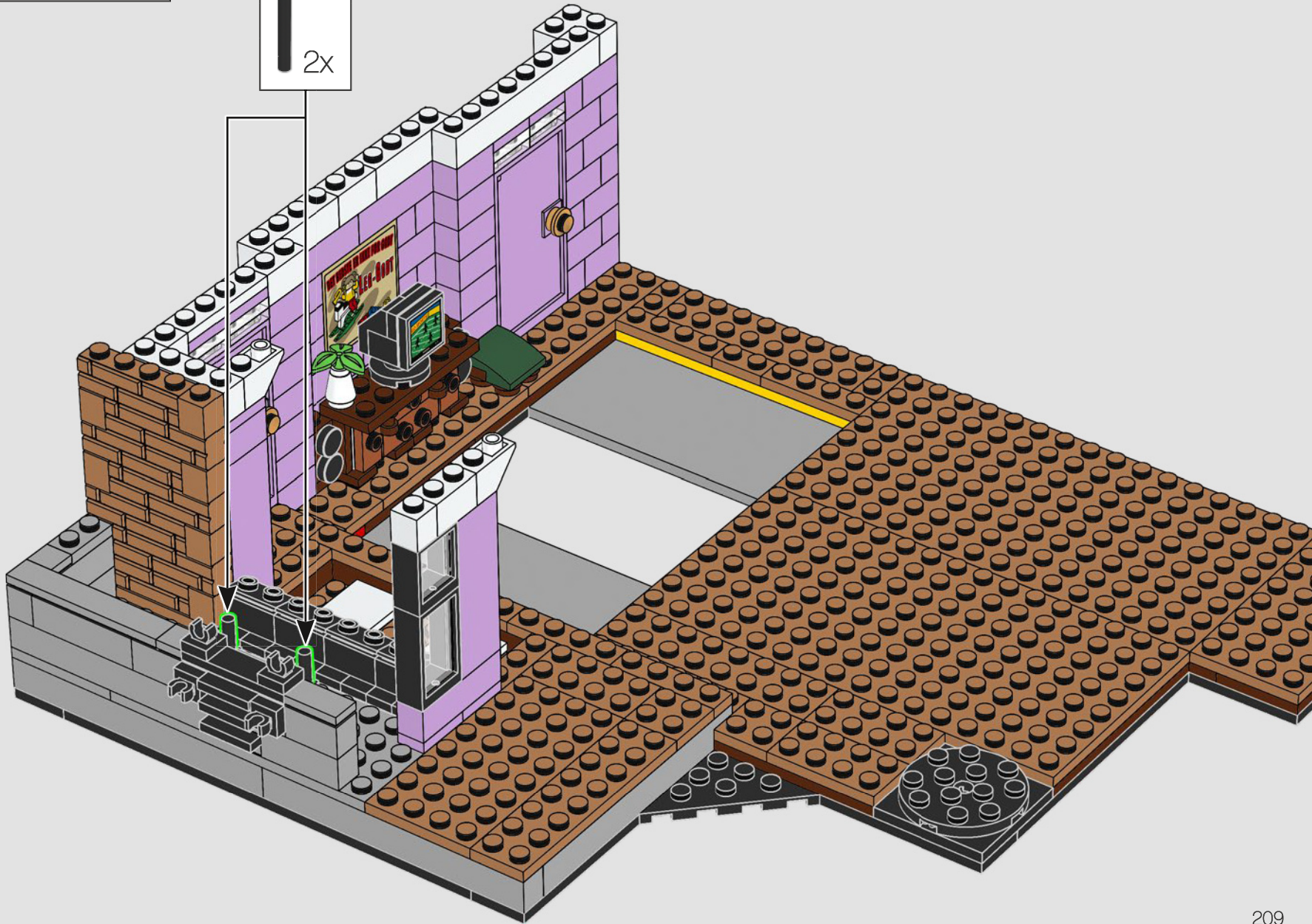



40

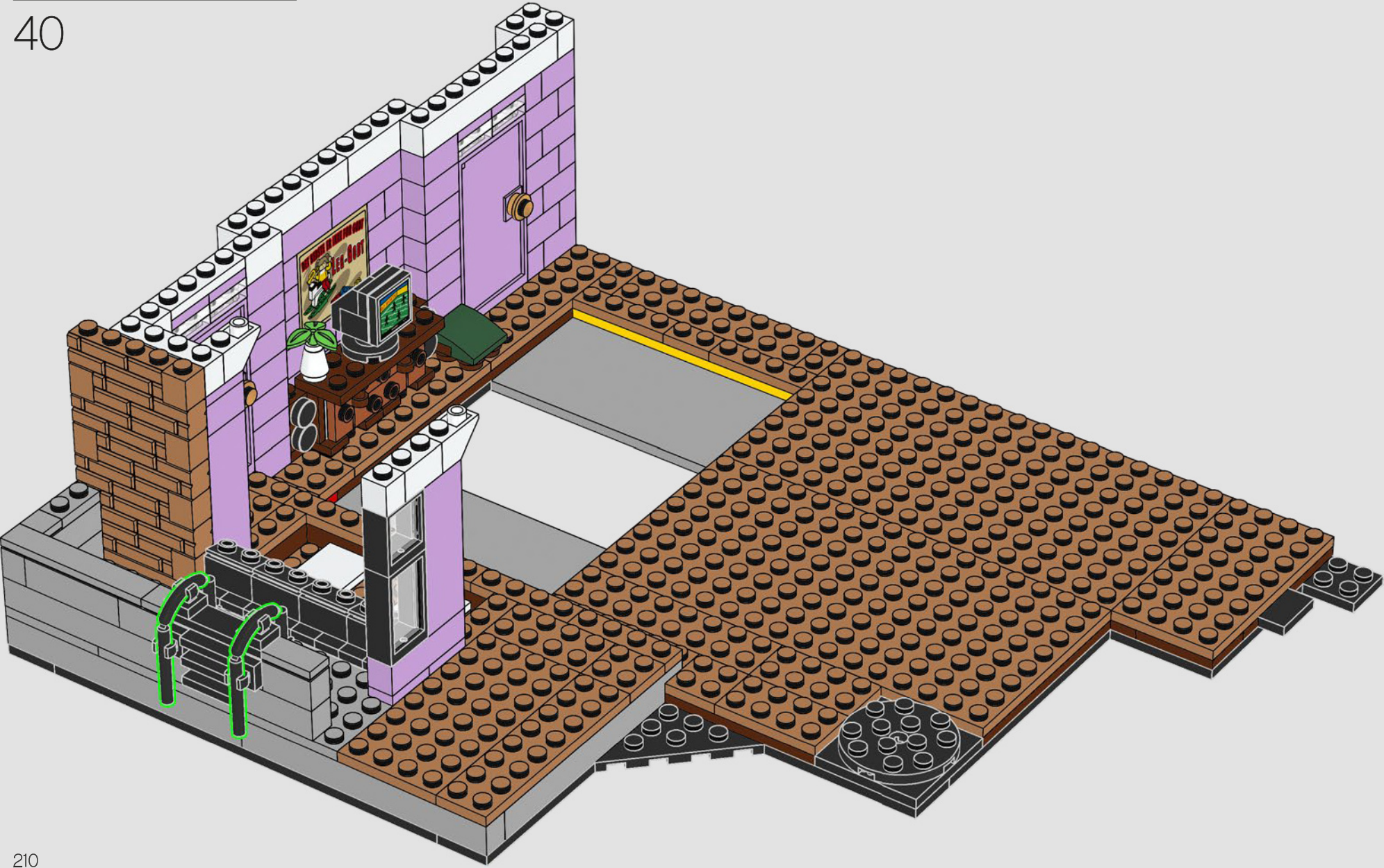

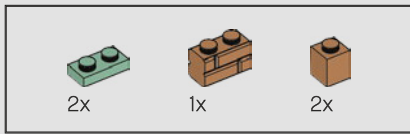

41

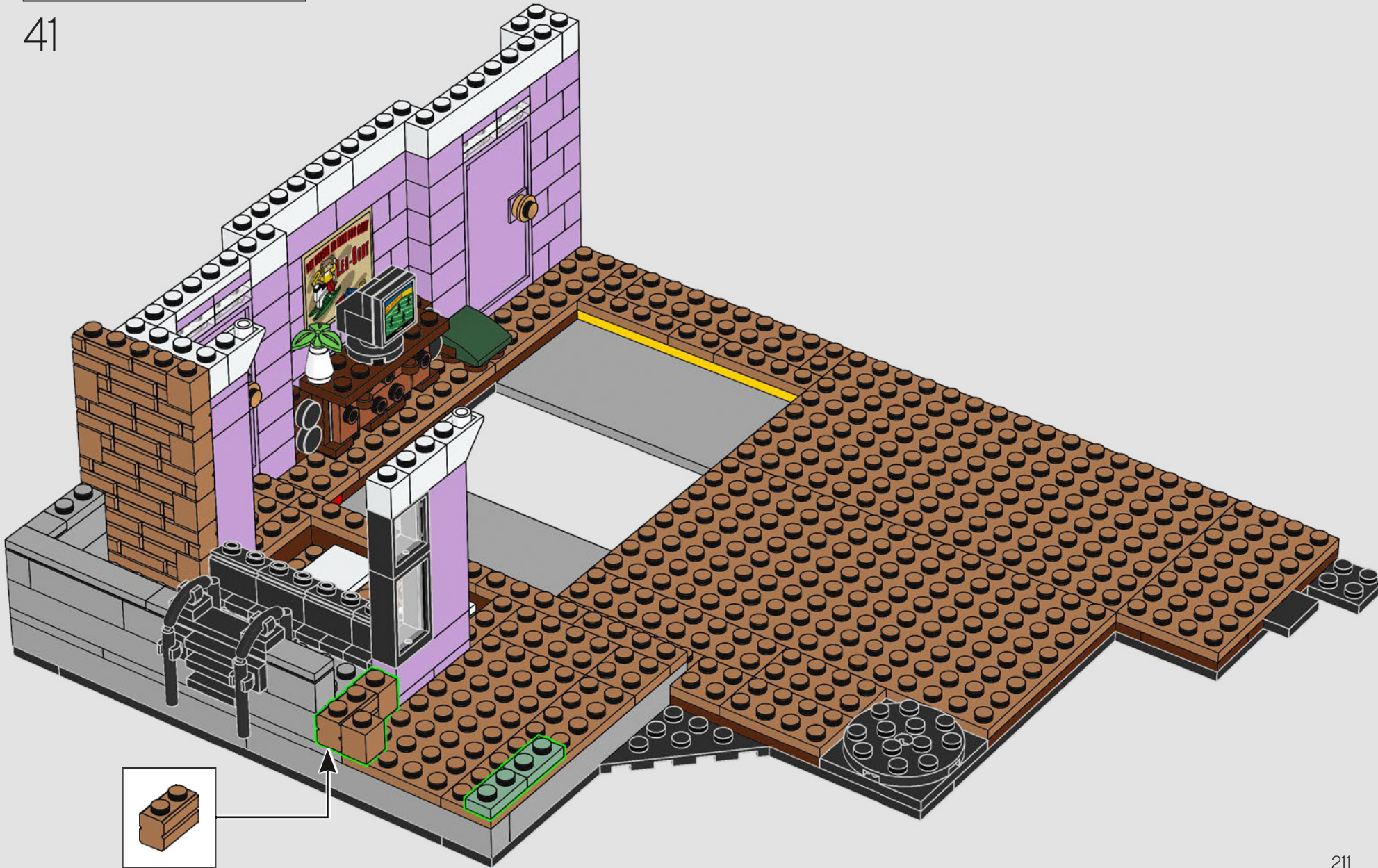

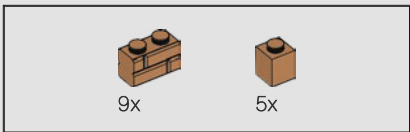

42

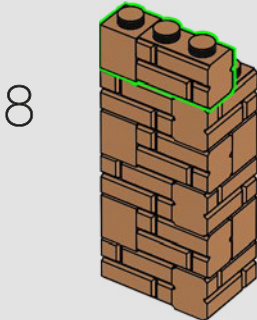
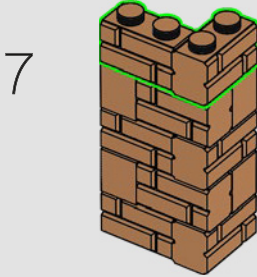
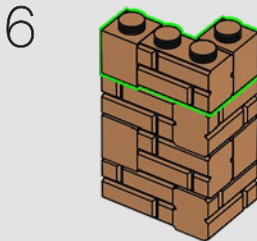
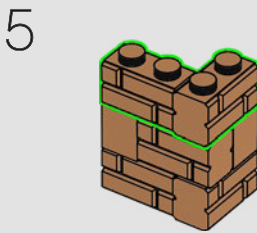
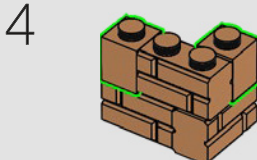
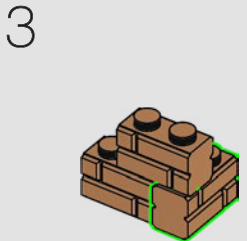
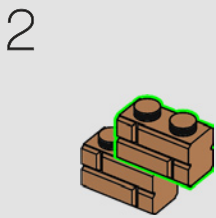

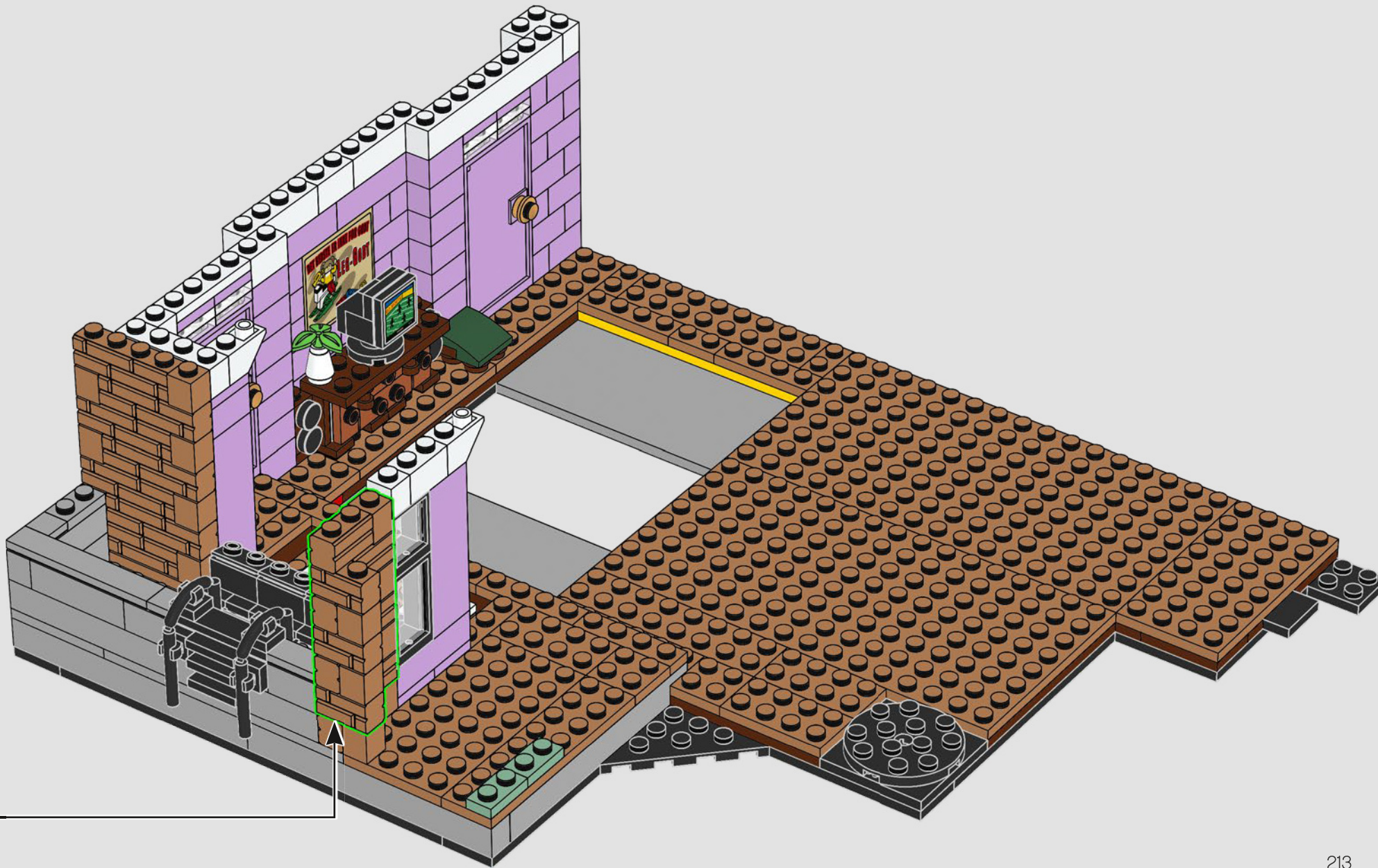

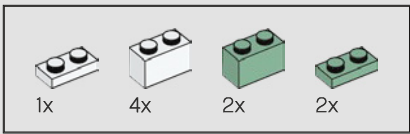

43

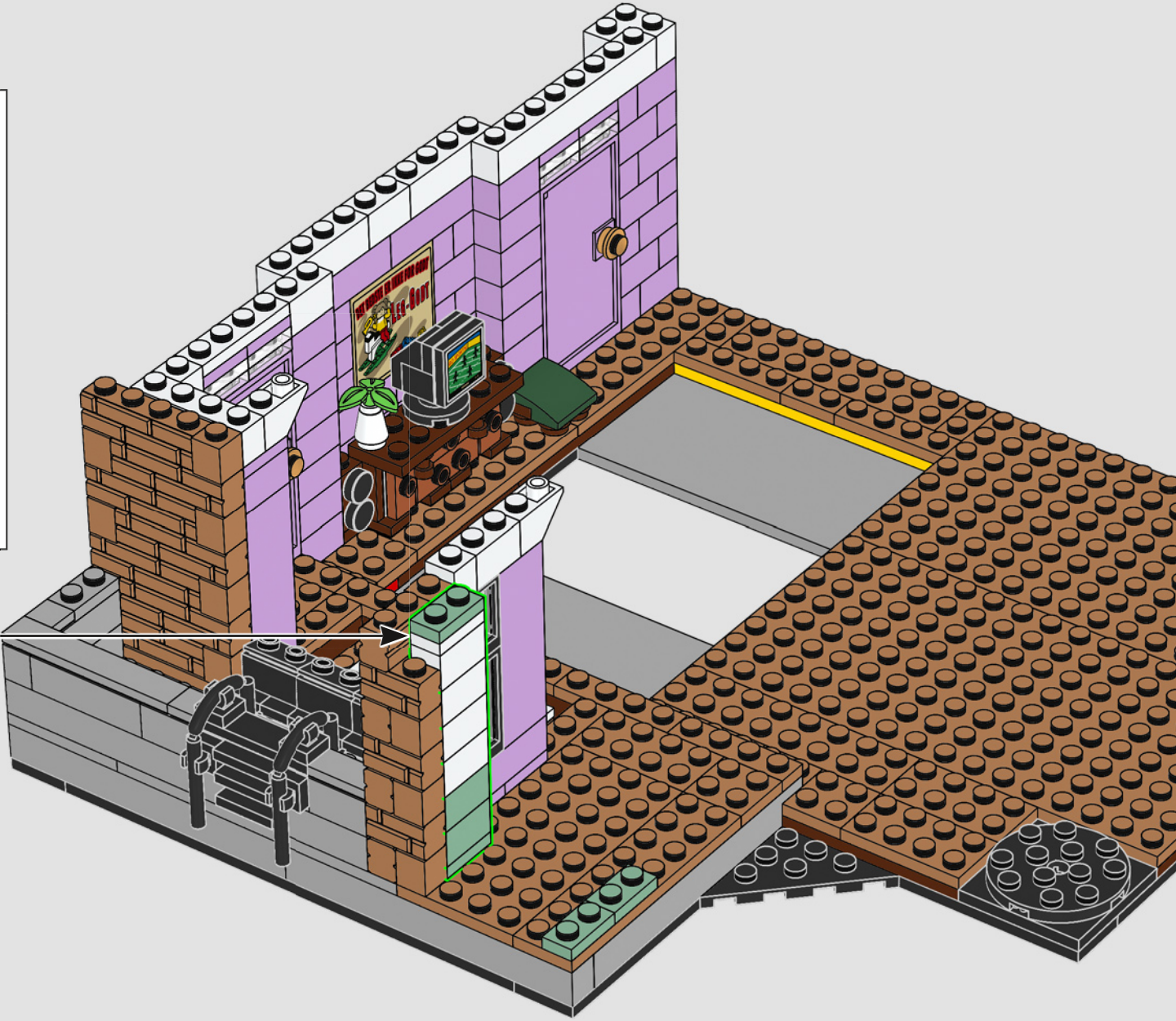
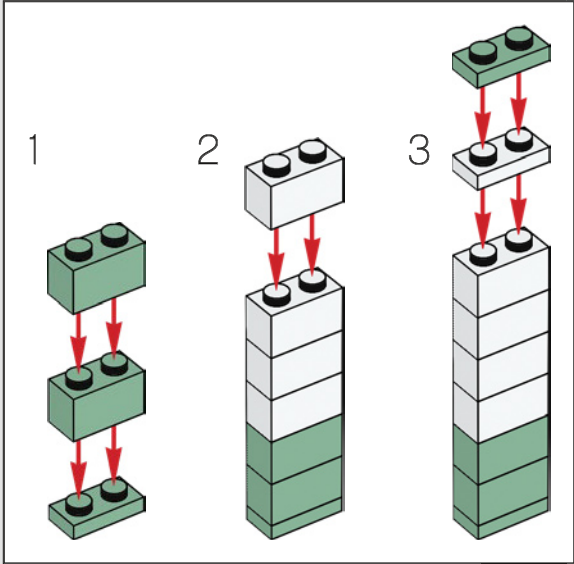

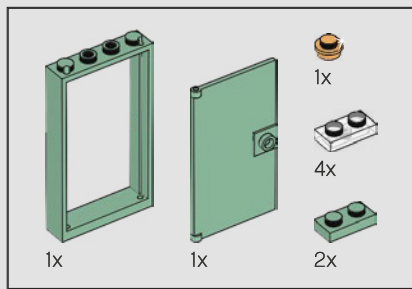

44

1

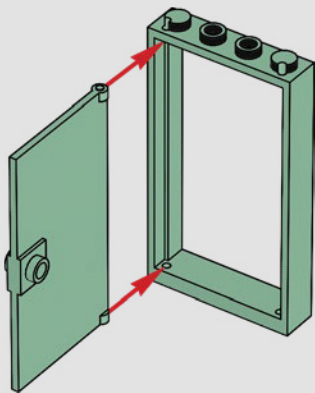

2

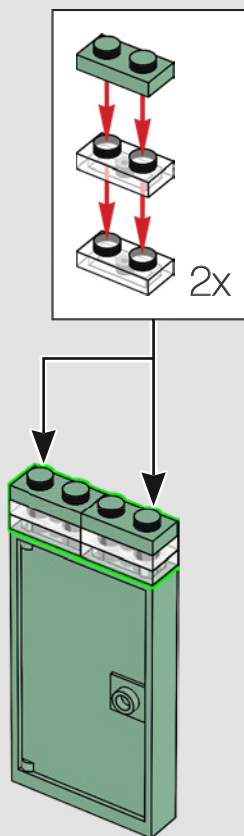

3

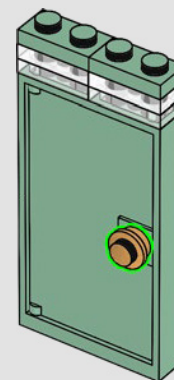

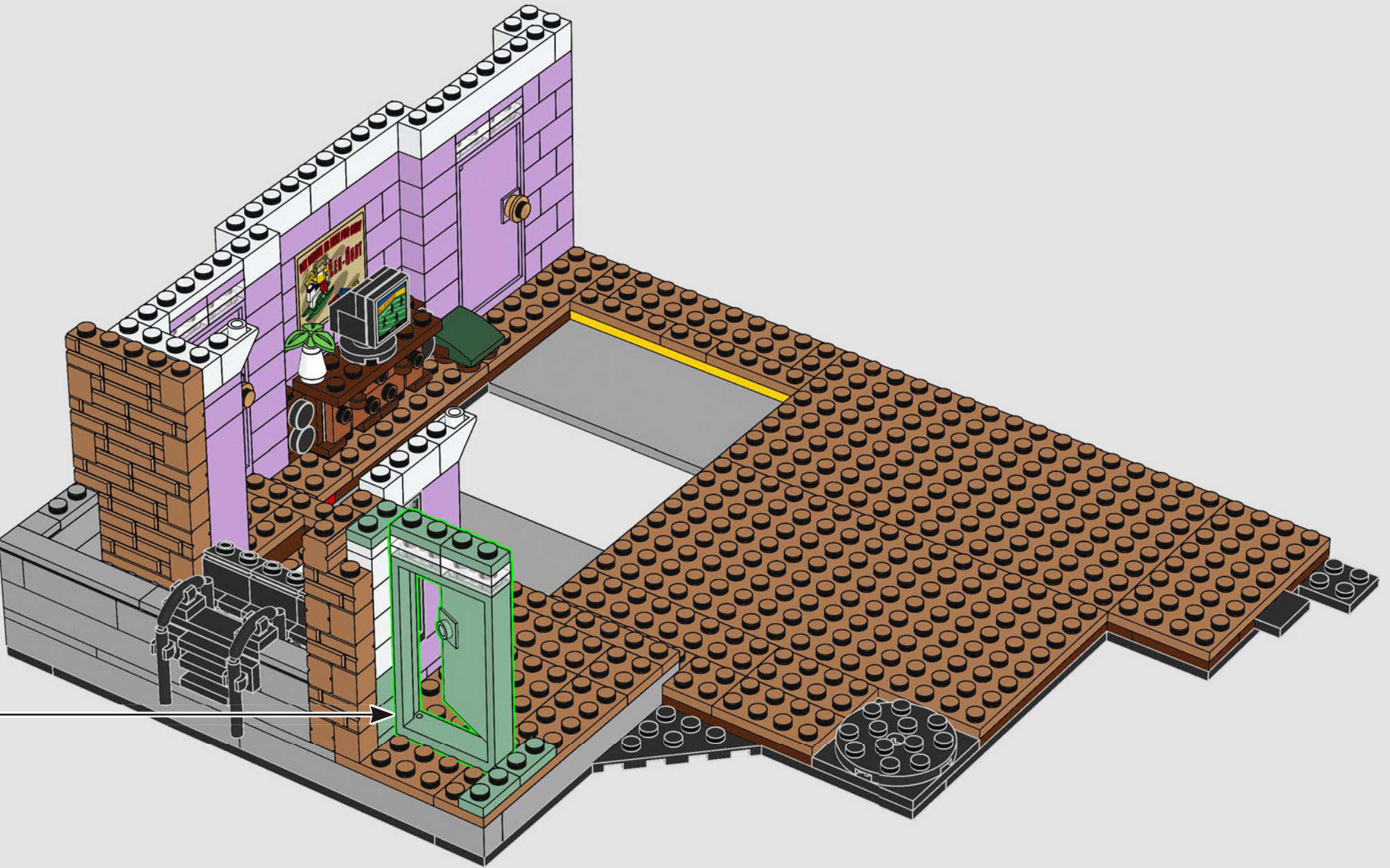

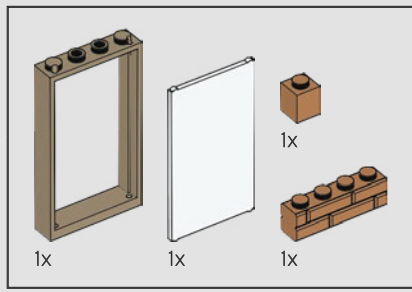

45

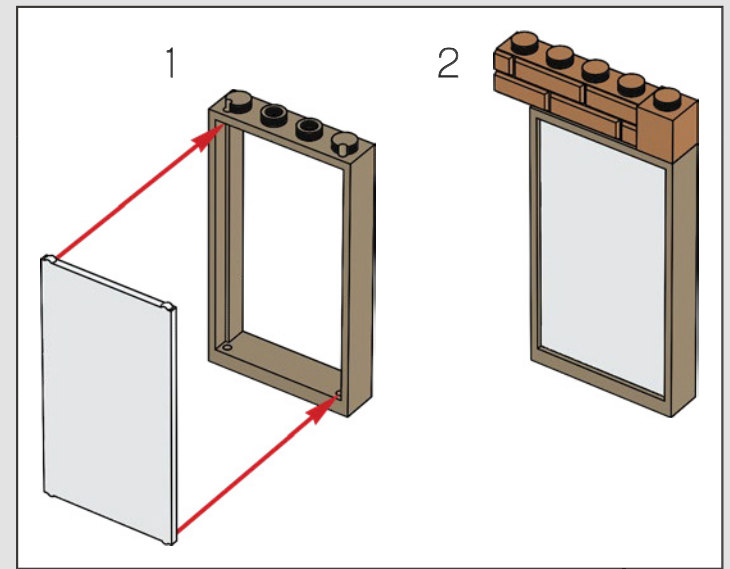
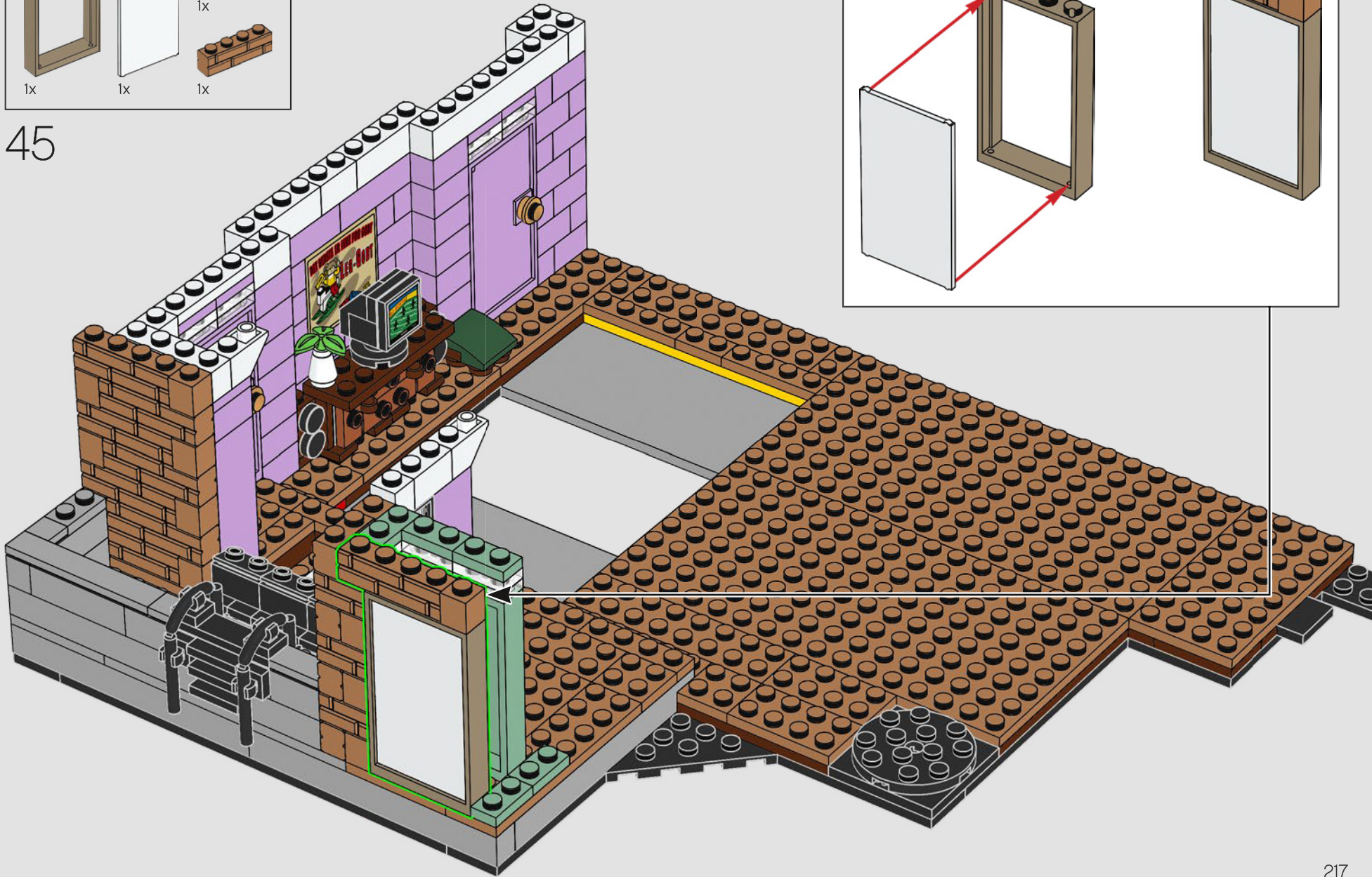

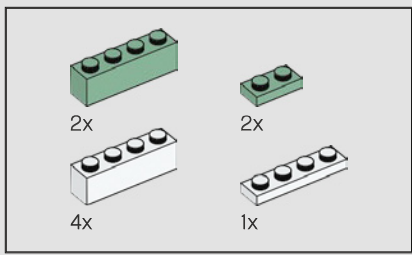

46

1

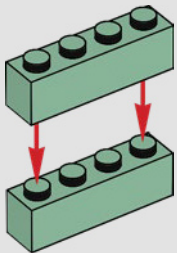

2

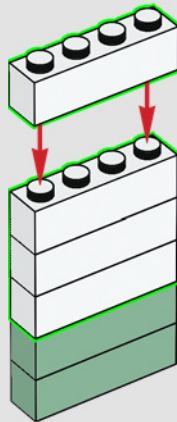

3

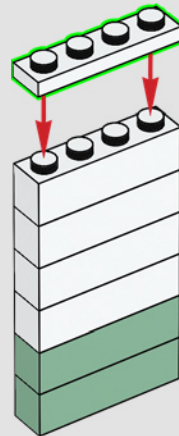

4

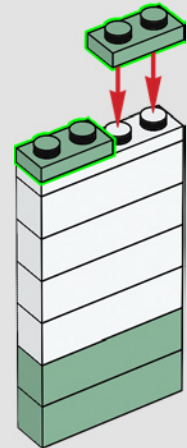

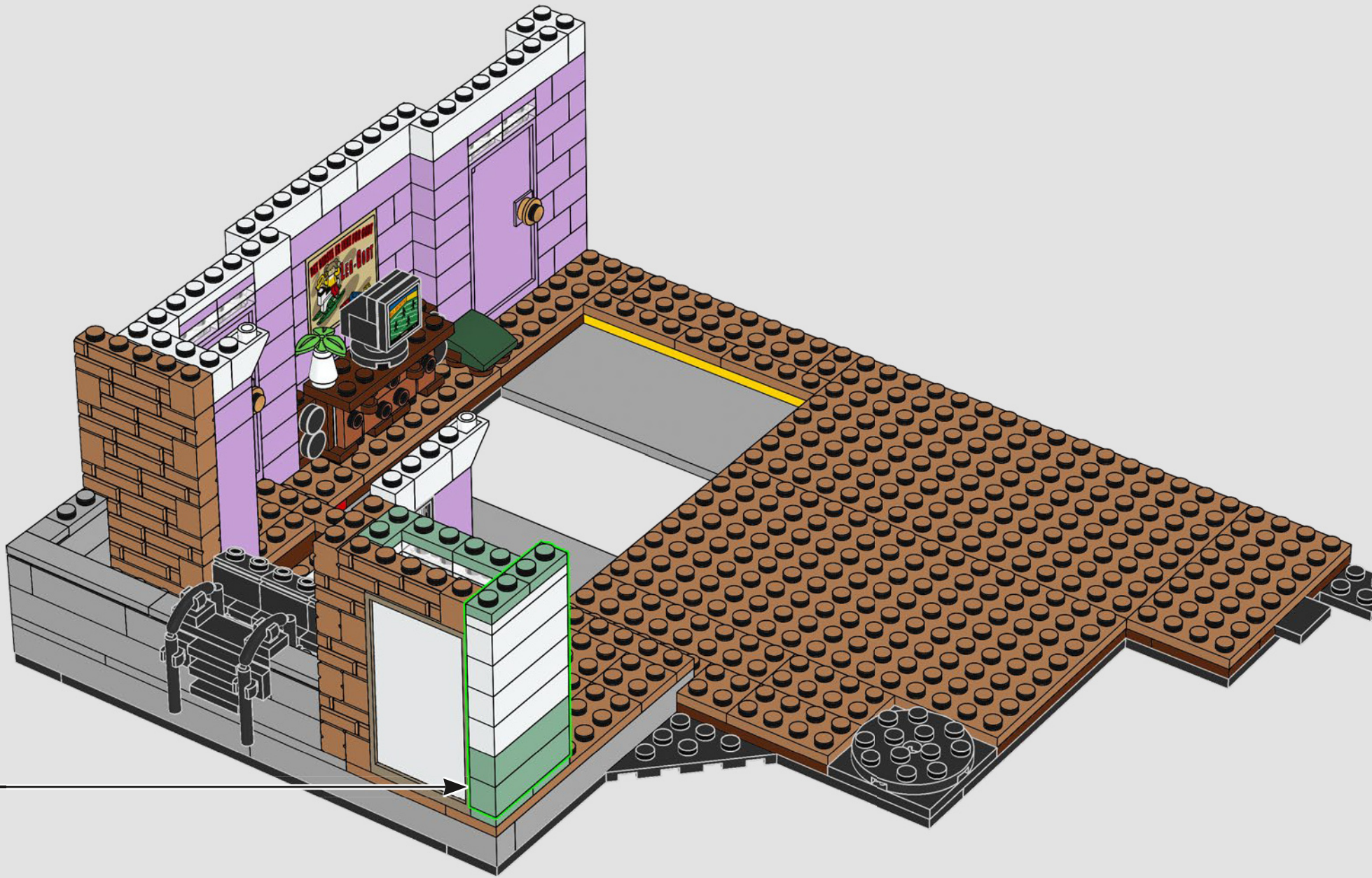

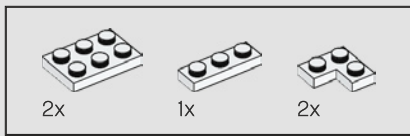

47



• The cat on the balcony that attacked Ross just as he was about to kiss Rachel.

• Le chat sur le balcon qui a attaqué Ross au moment où il allait embrasser Rachel.

• El gato del balcón es por el que atacó a Ross cuando estaba a punto de besar a Rachel.



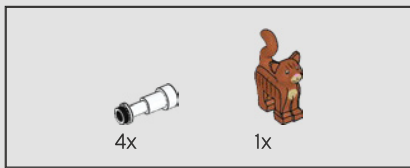

48

● The 'poking stick' that they used to check on their neighbor in the opposite building when they thought he'd died.

● Le bâton qu'ils ont apporté quand ils sont allés vérifier si leur voisin dans le bâtiment d'en face était bien mort.

● El "artilugio punzante" es el que usaron para revisar a su vecino del edificio de enfrente cuando pensaron que había muerto.



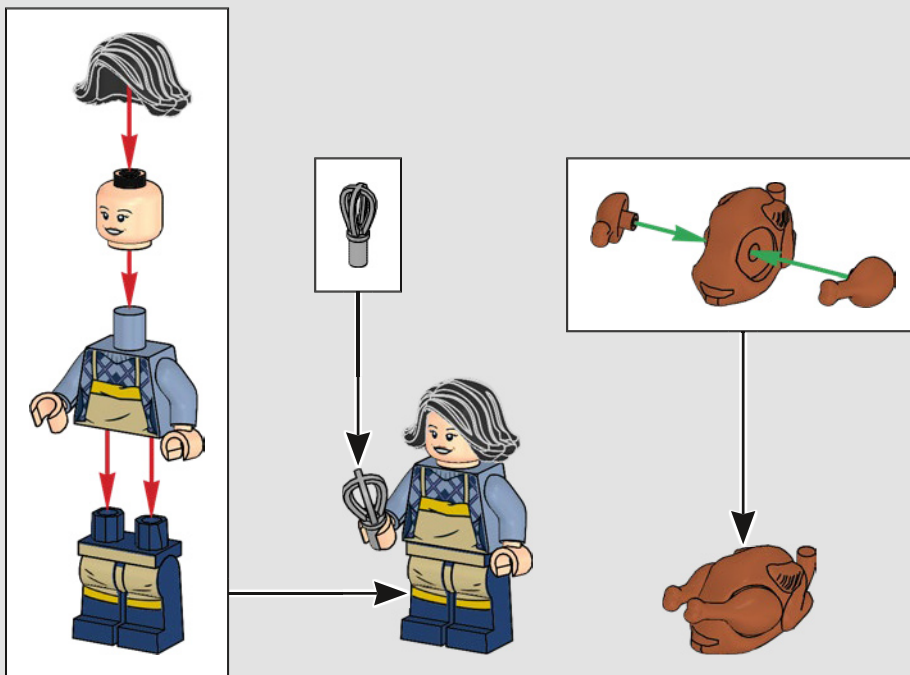
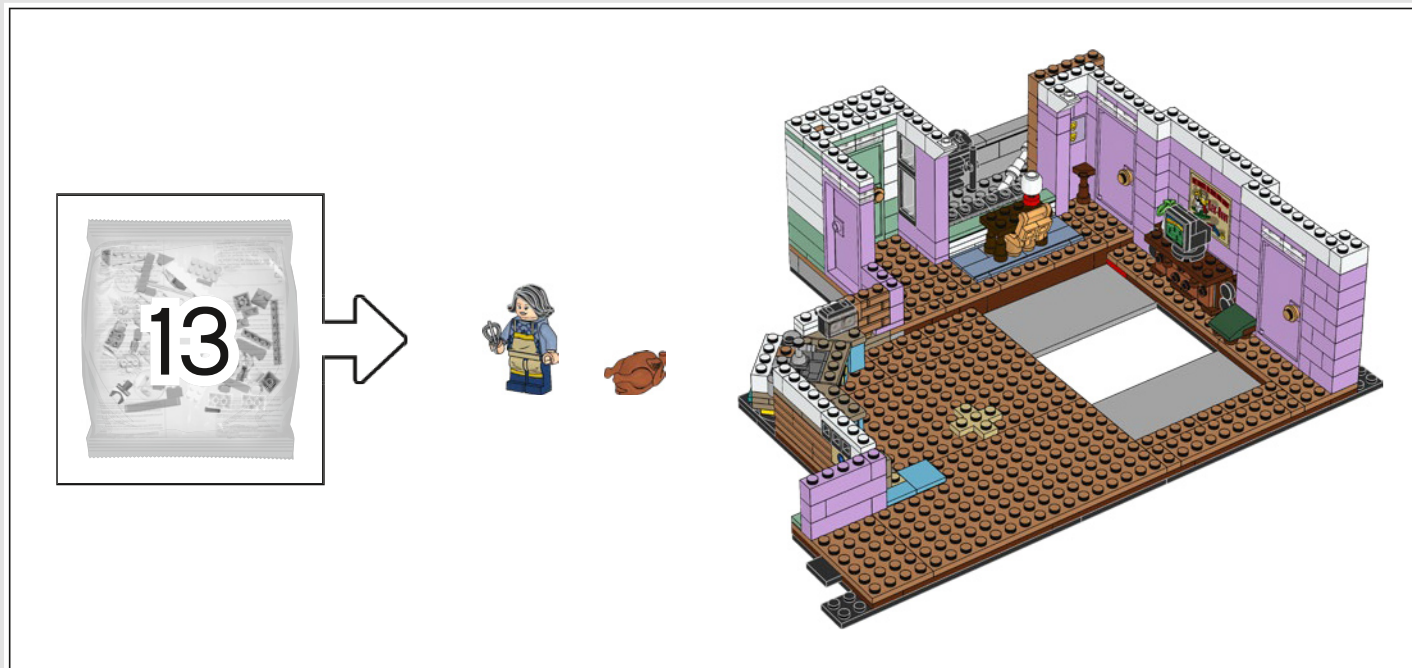

● The turkey is from the famous Thanksgiving episode when Monica wore a turkey on her head.

● La dinde provient du célèbre épisode de l'Action de grâce, où Monica portait une dinde sur la tête.

● Hay un pavo por el que usó Monica en la cabeza en el famoso episodio del Día de Acción de Gracias.

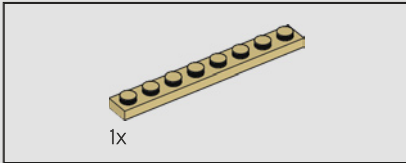
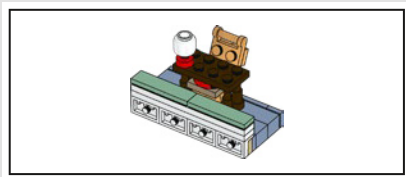

49

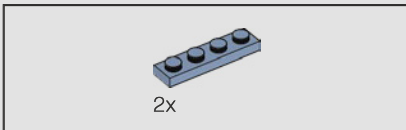
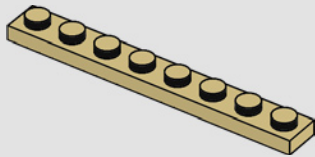

50

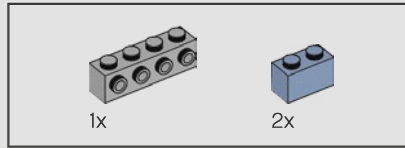
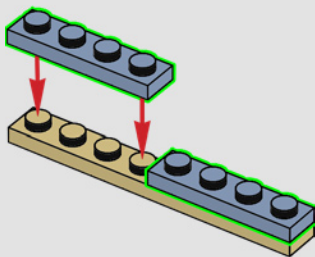

51

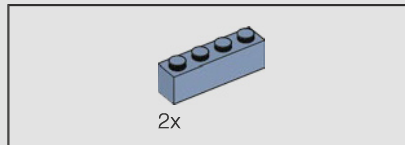
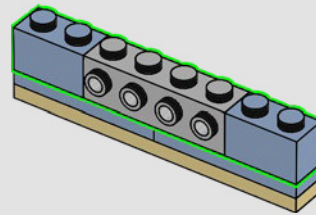

52

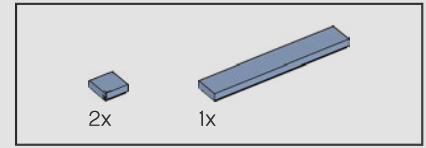
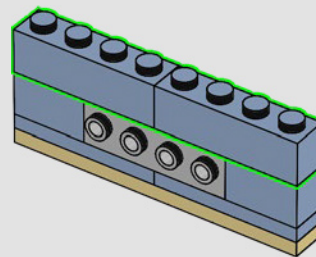

53

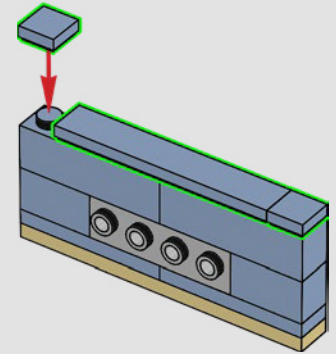

54

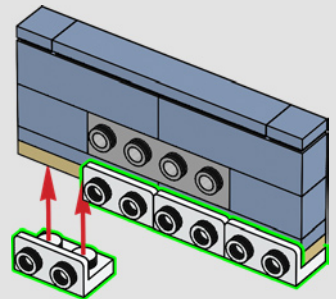



55

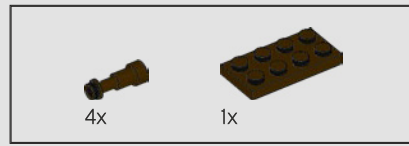
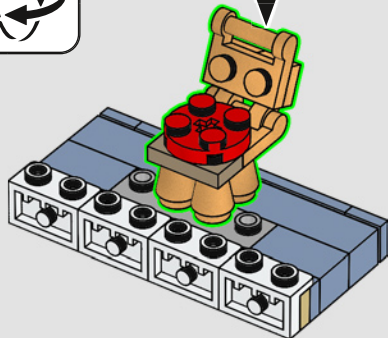
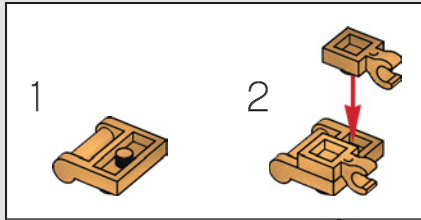
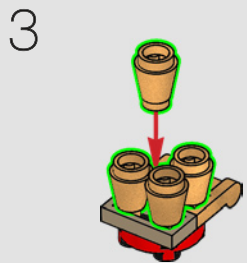

56

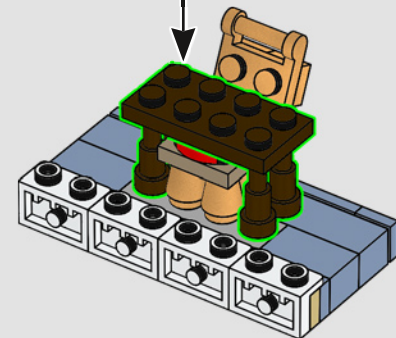
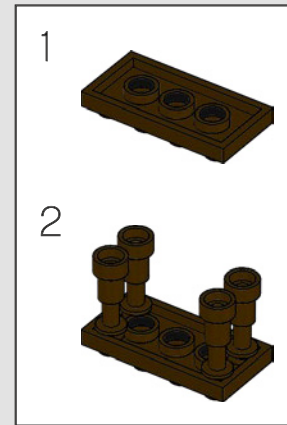

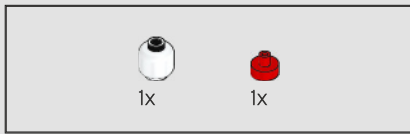

57

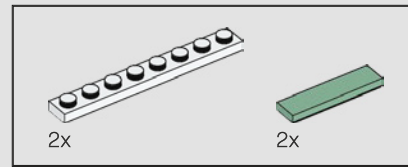
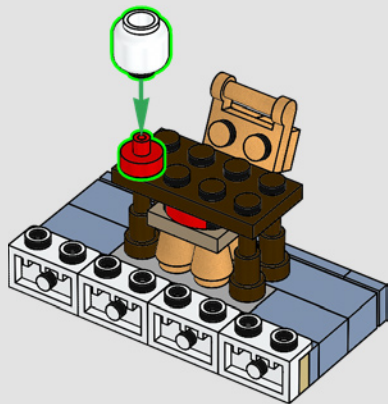

58

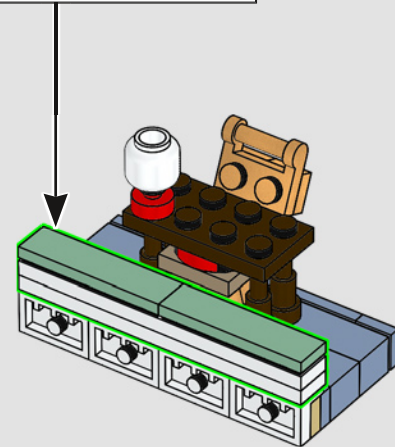
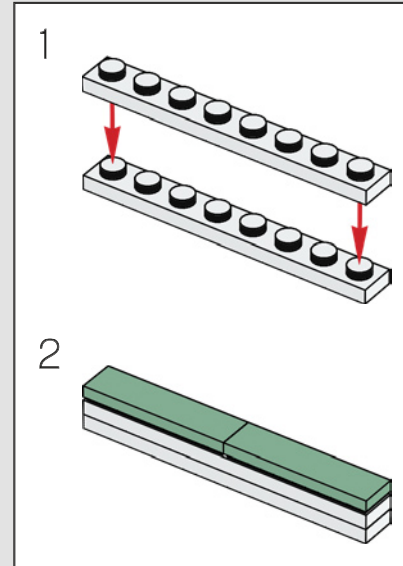



59

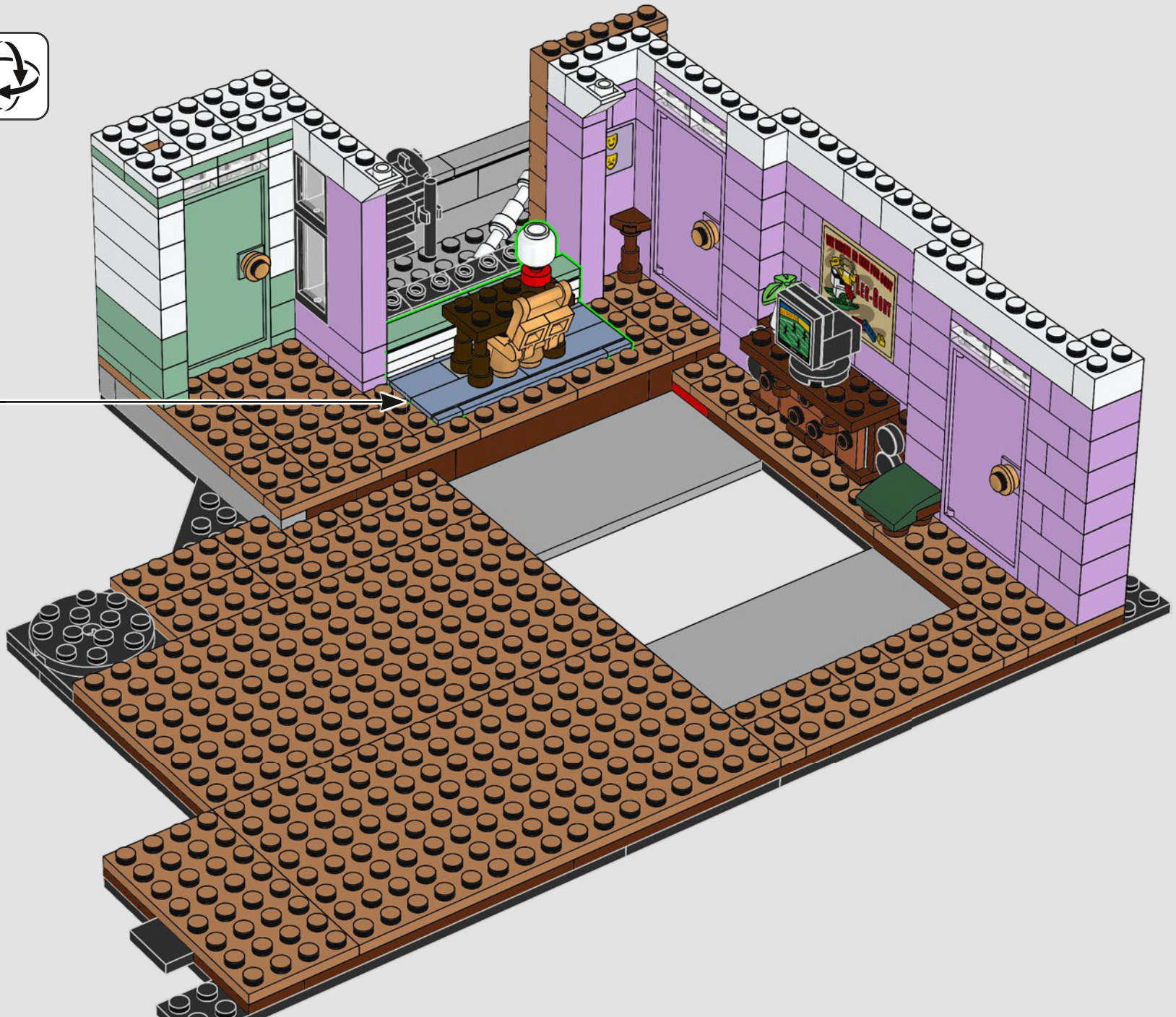

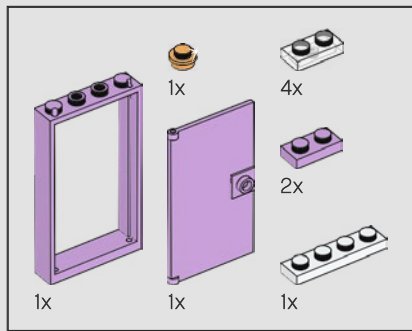

60

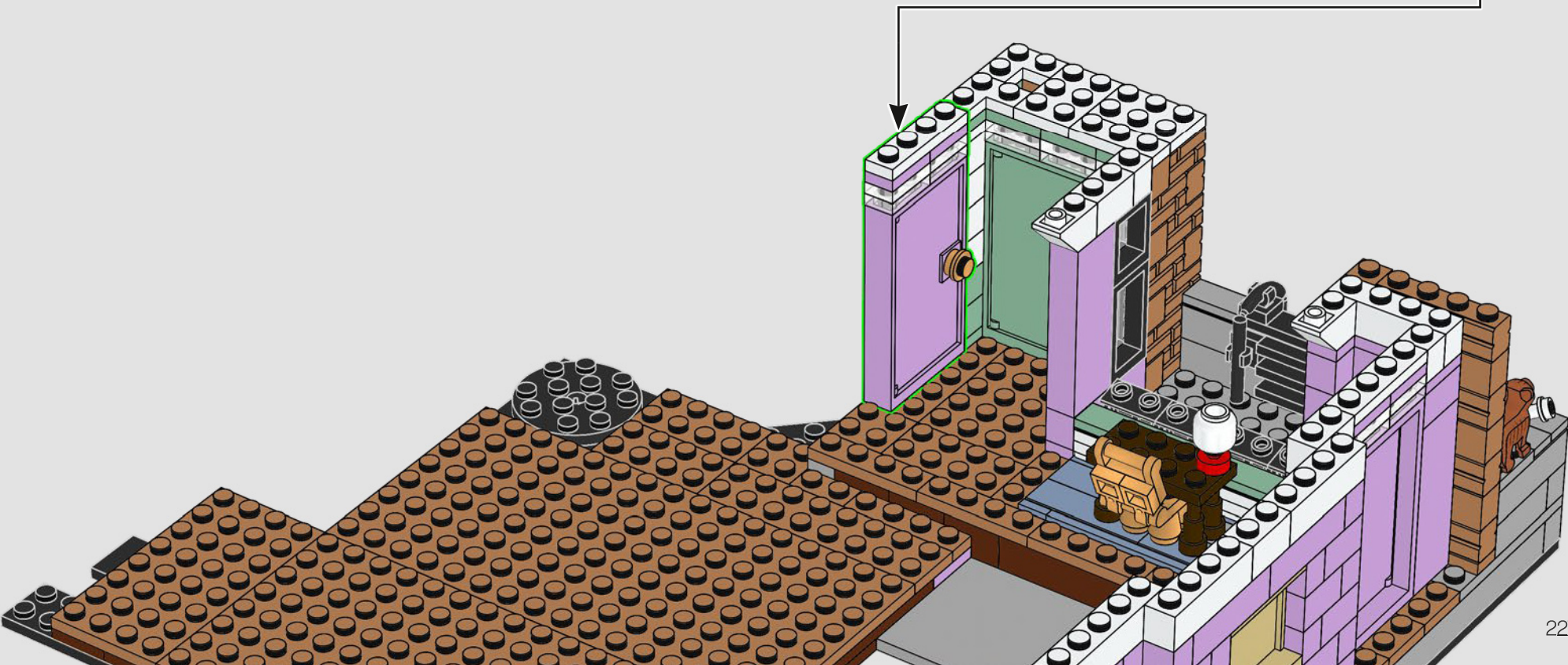
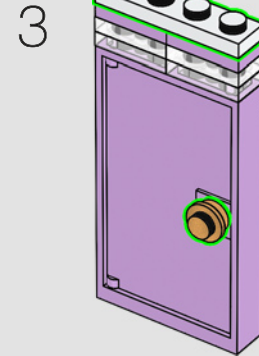
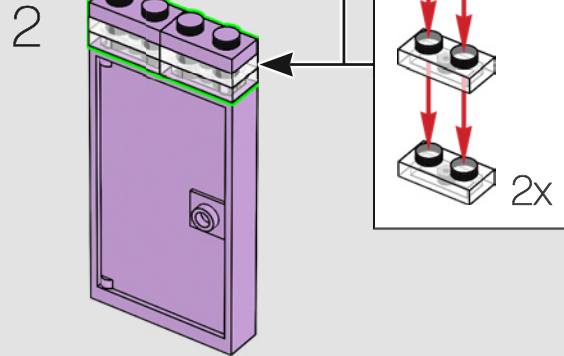
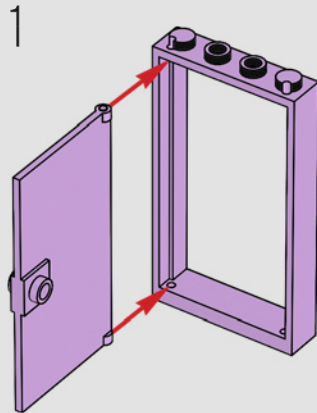

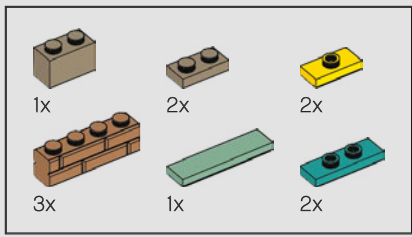

61

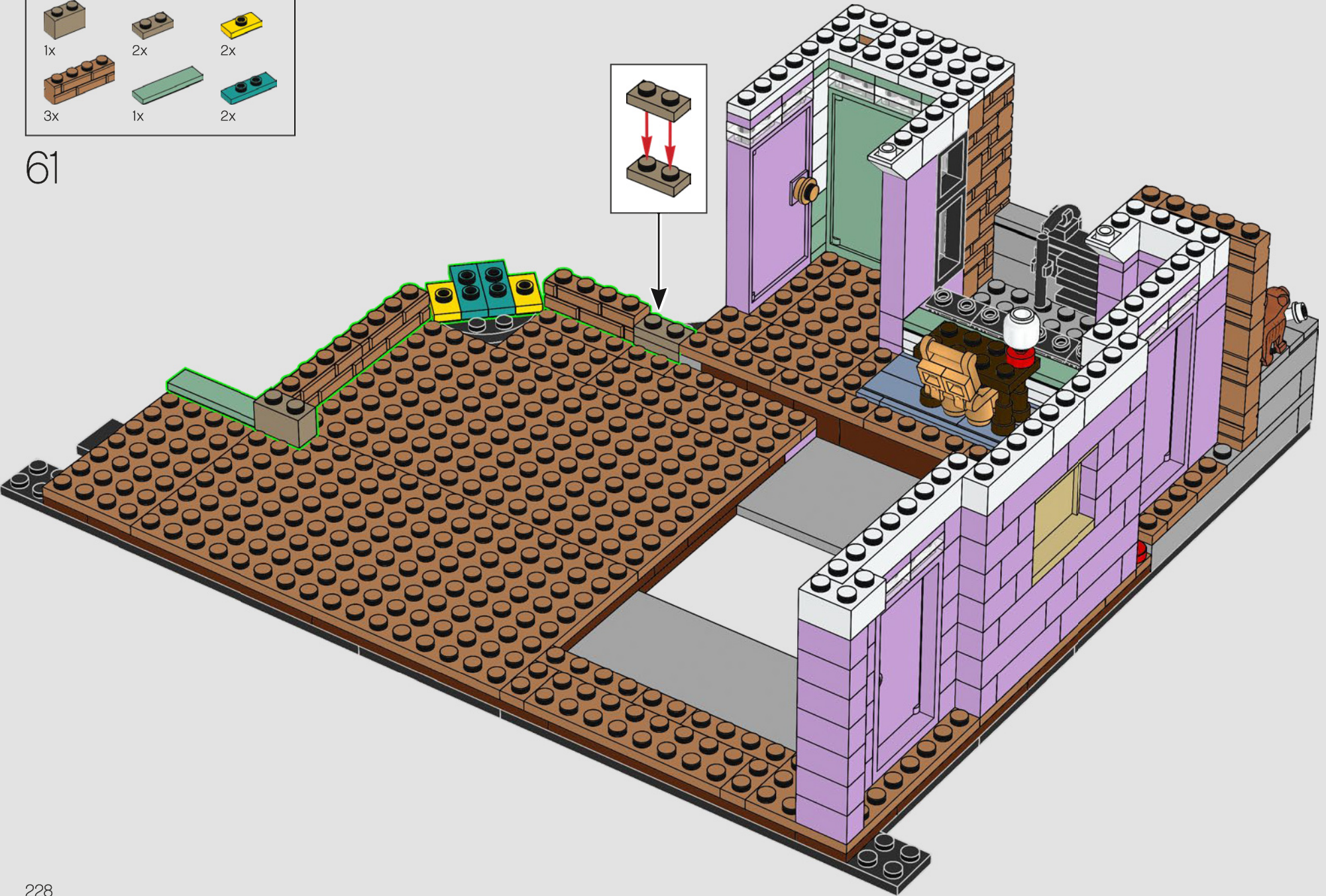
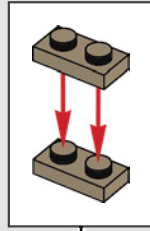

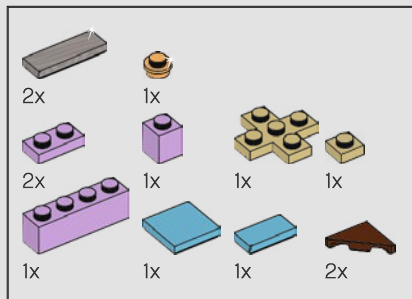

62

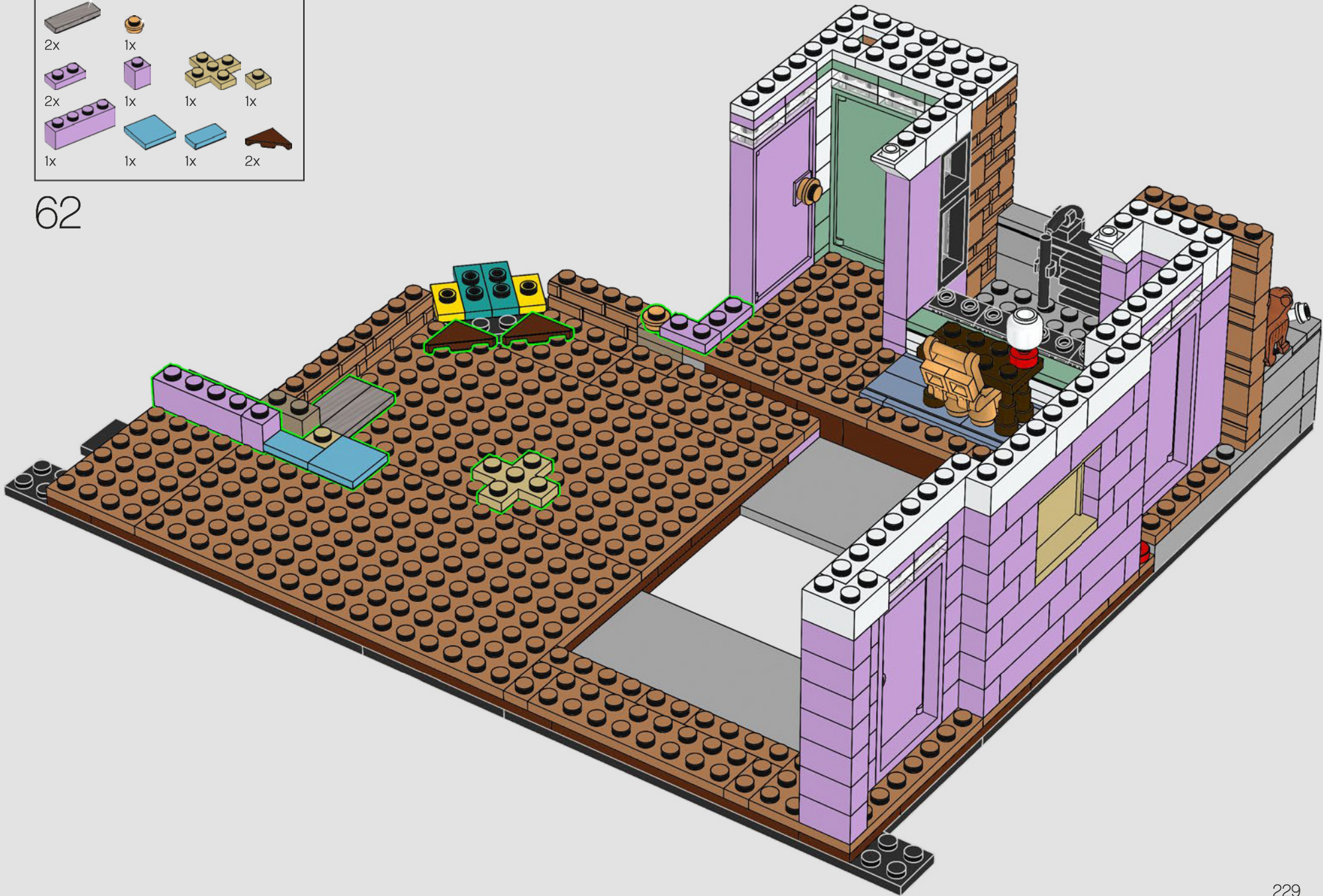

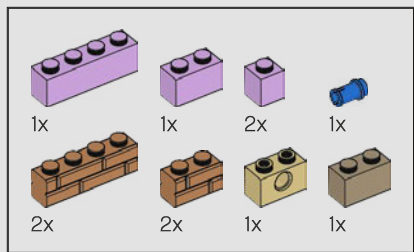

63

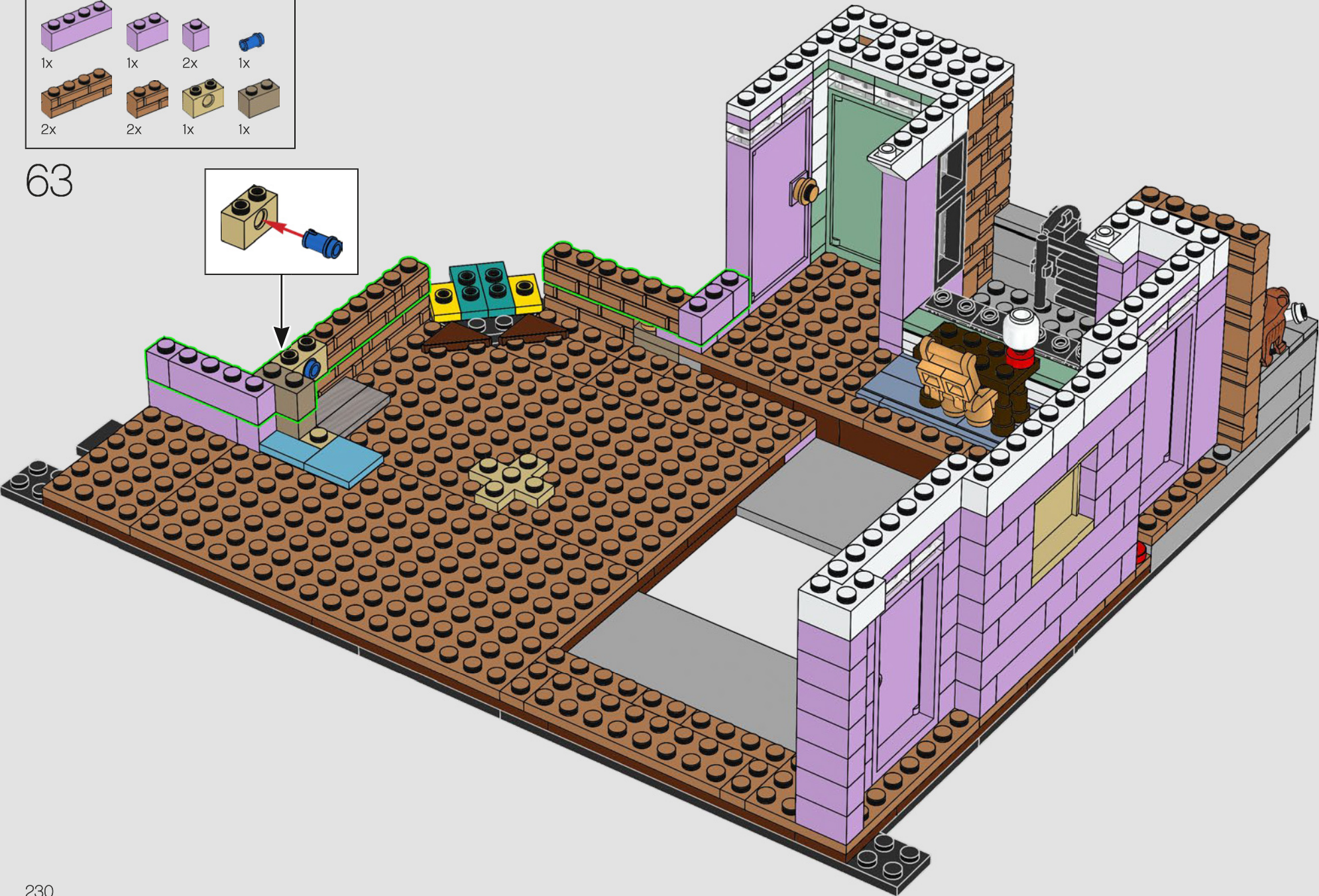
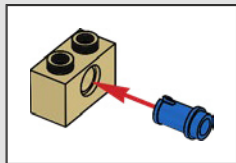

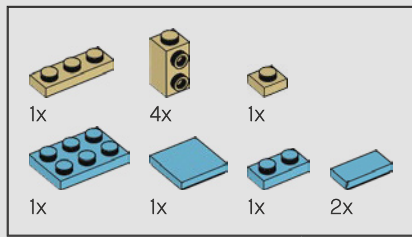

64

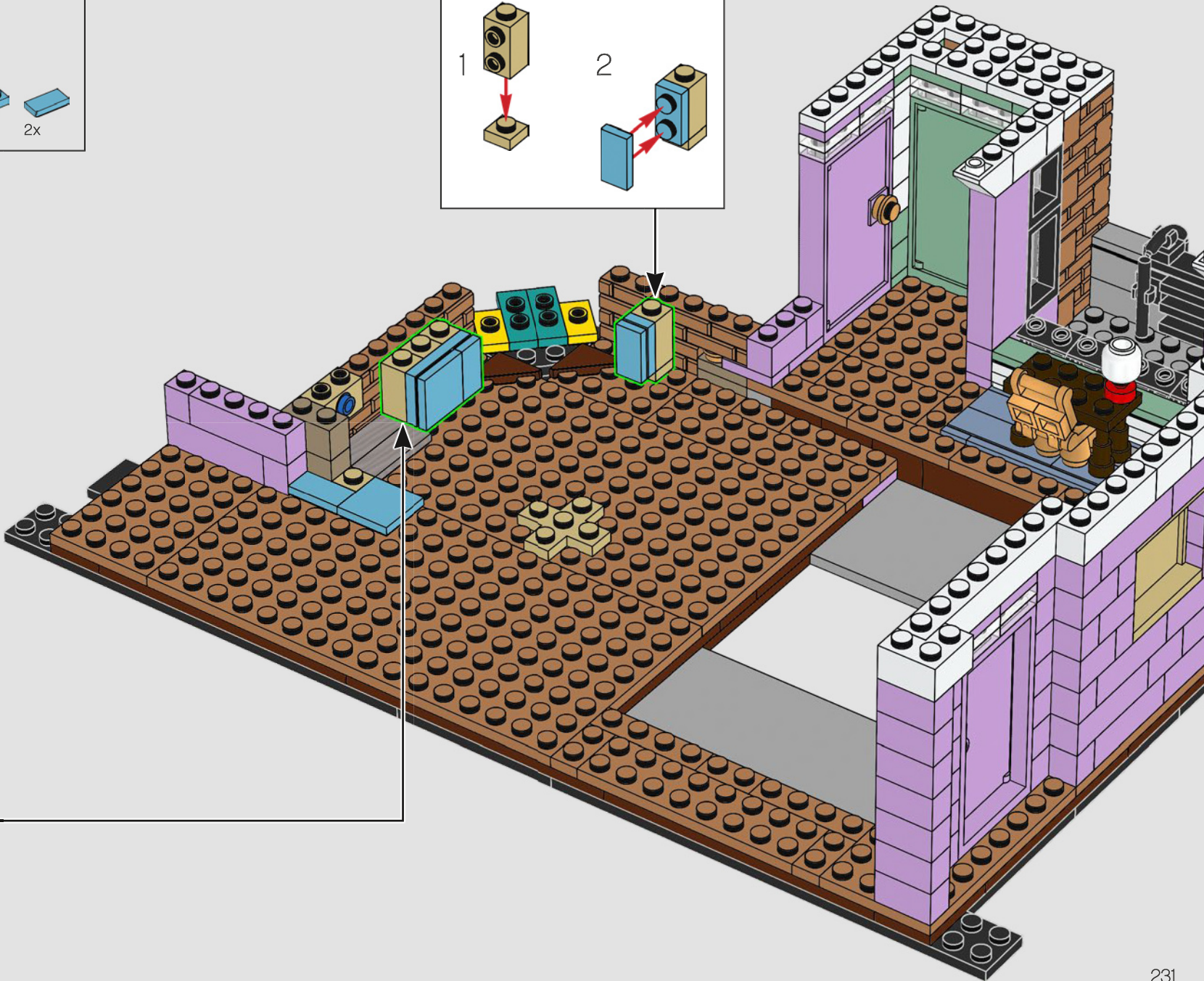
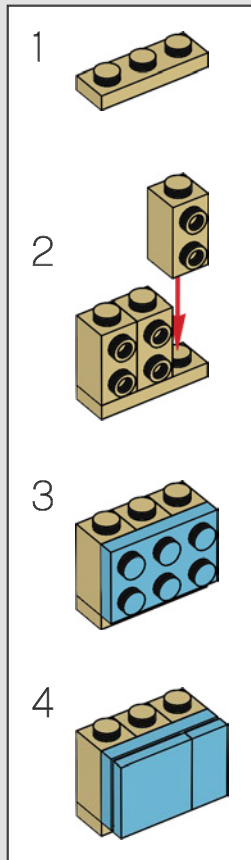
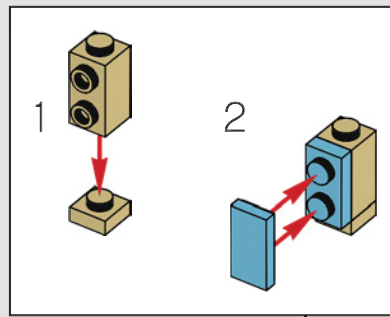

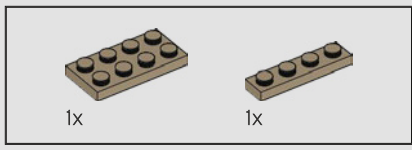

65

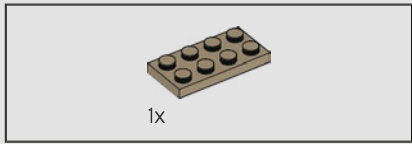
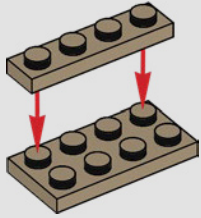

66

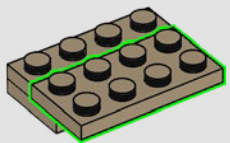

67

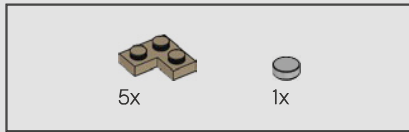
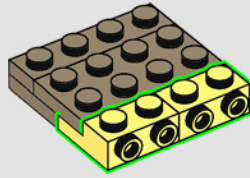

68

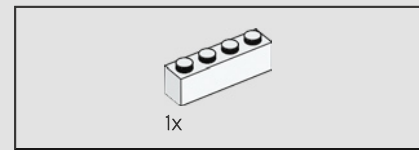
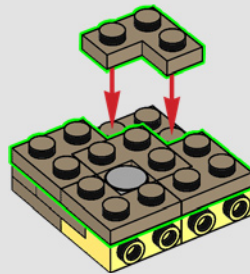

69

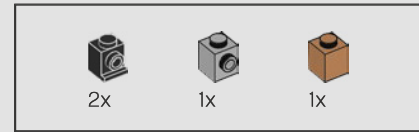
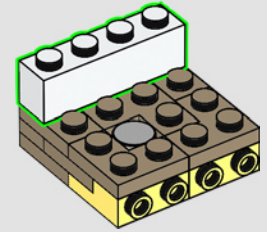

70

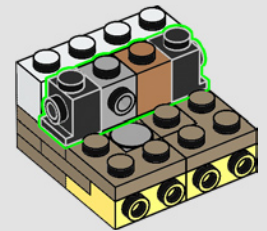



71

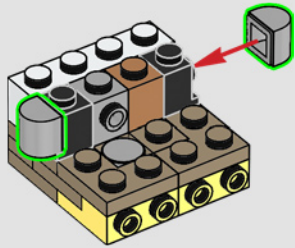

72

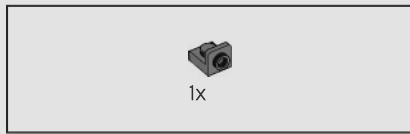
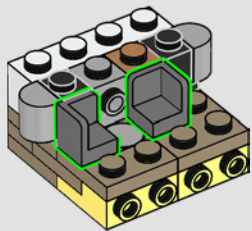

73

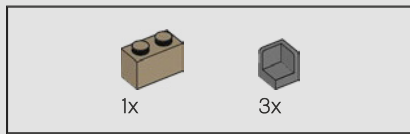
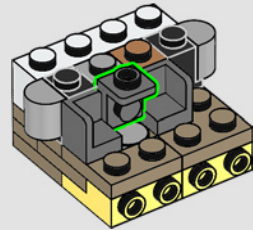

74

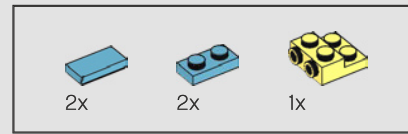
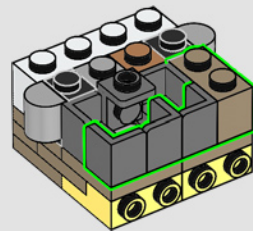

75

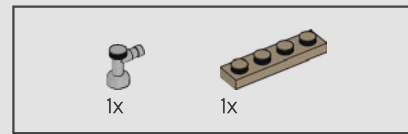
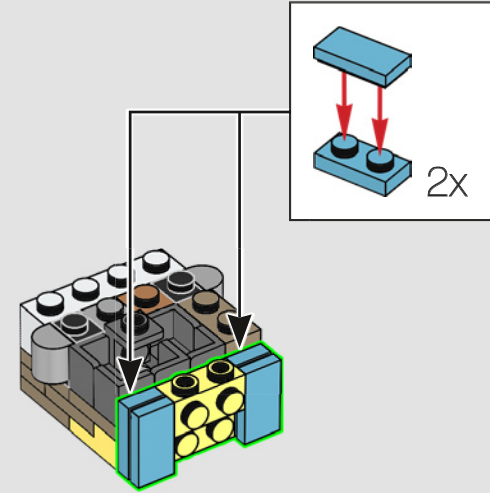

76

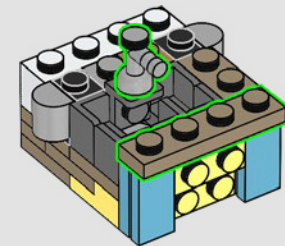

77

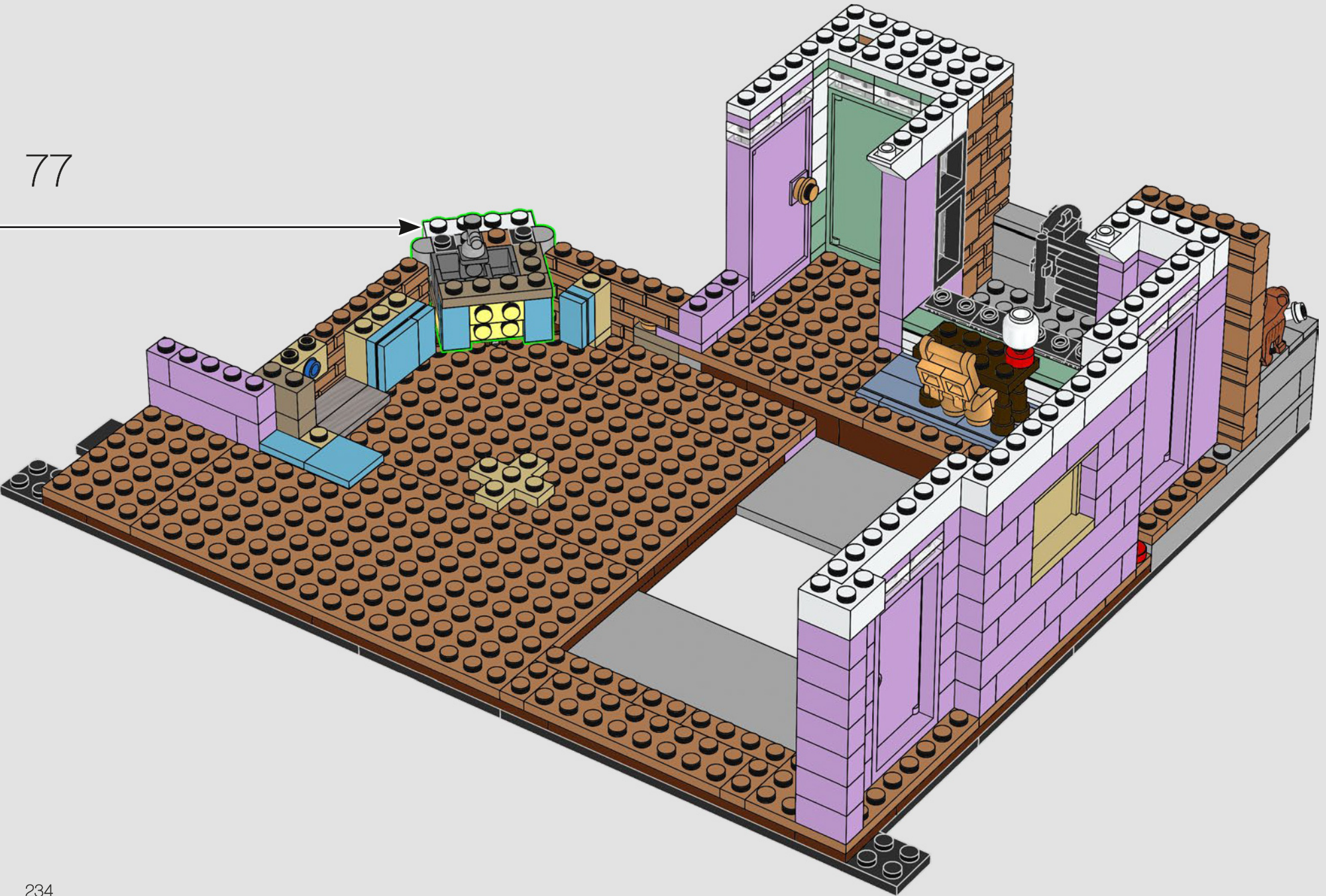

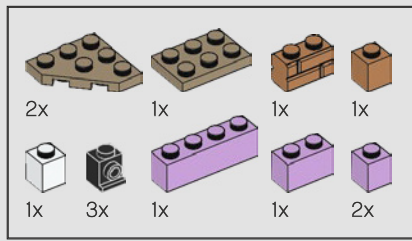

78

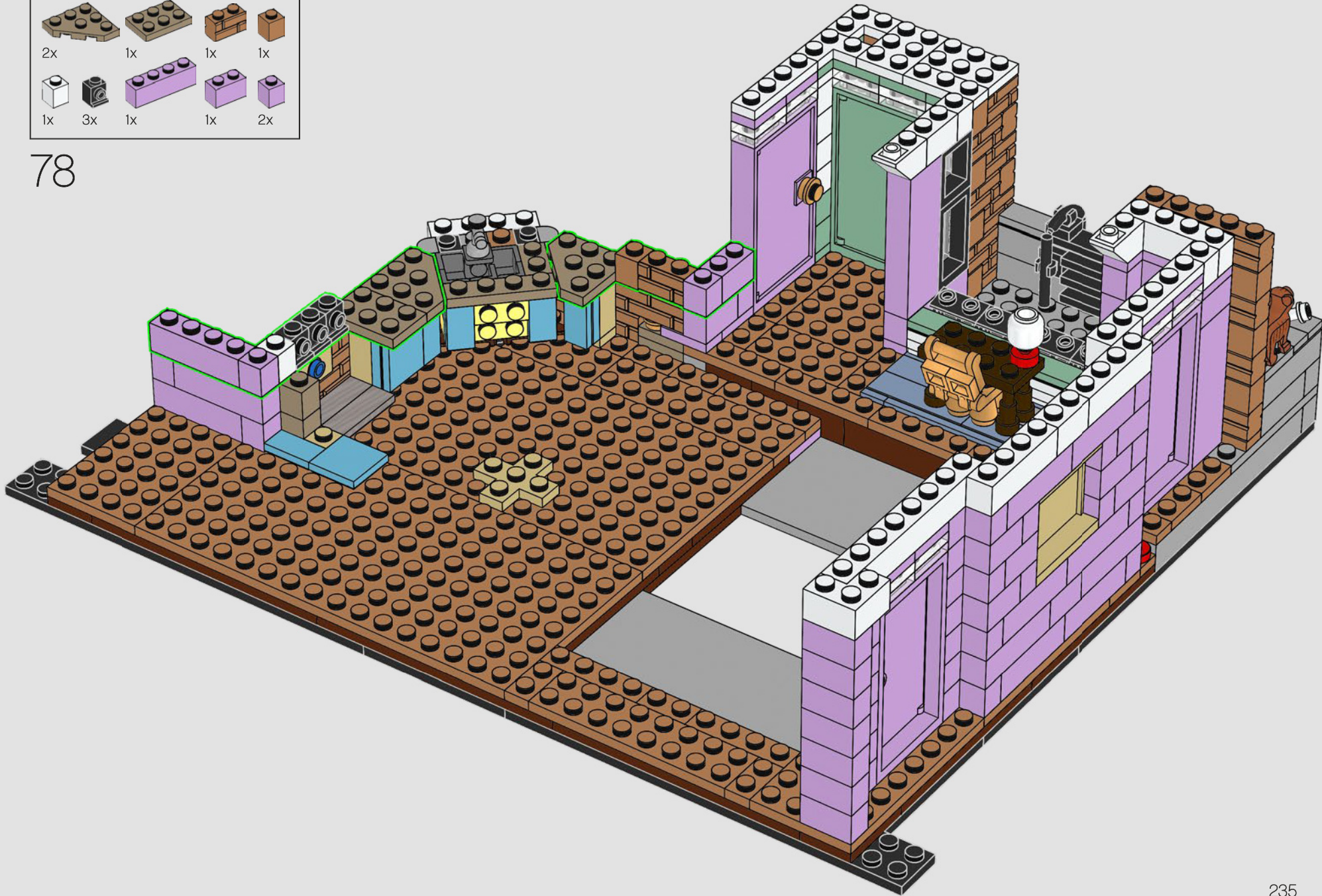

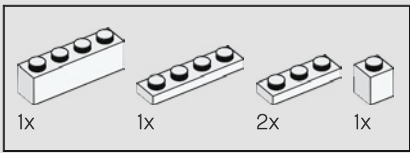

79

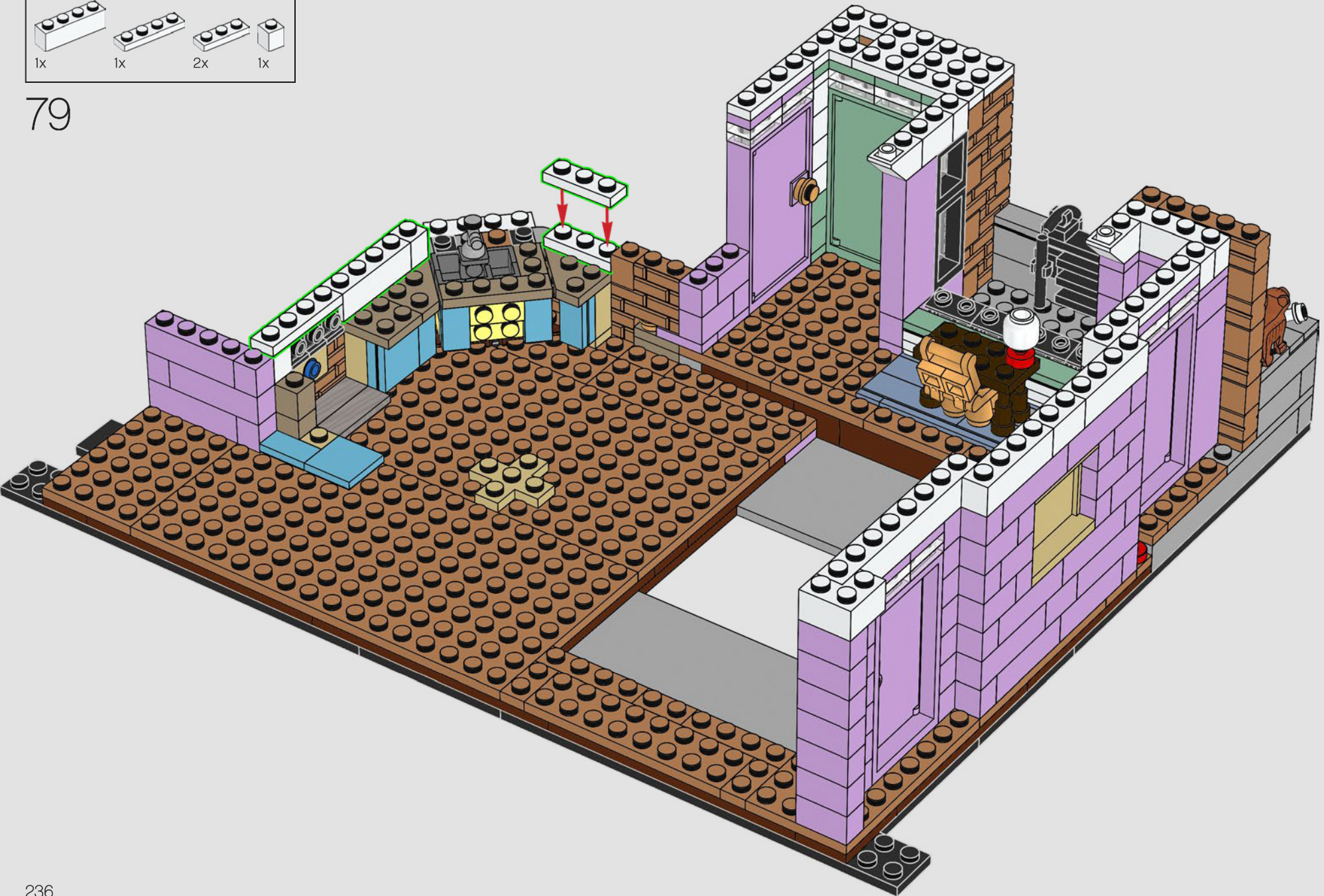

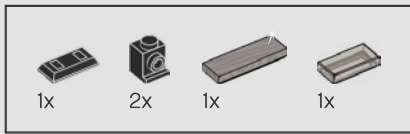

80

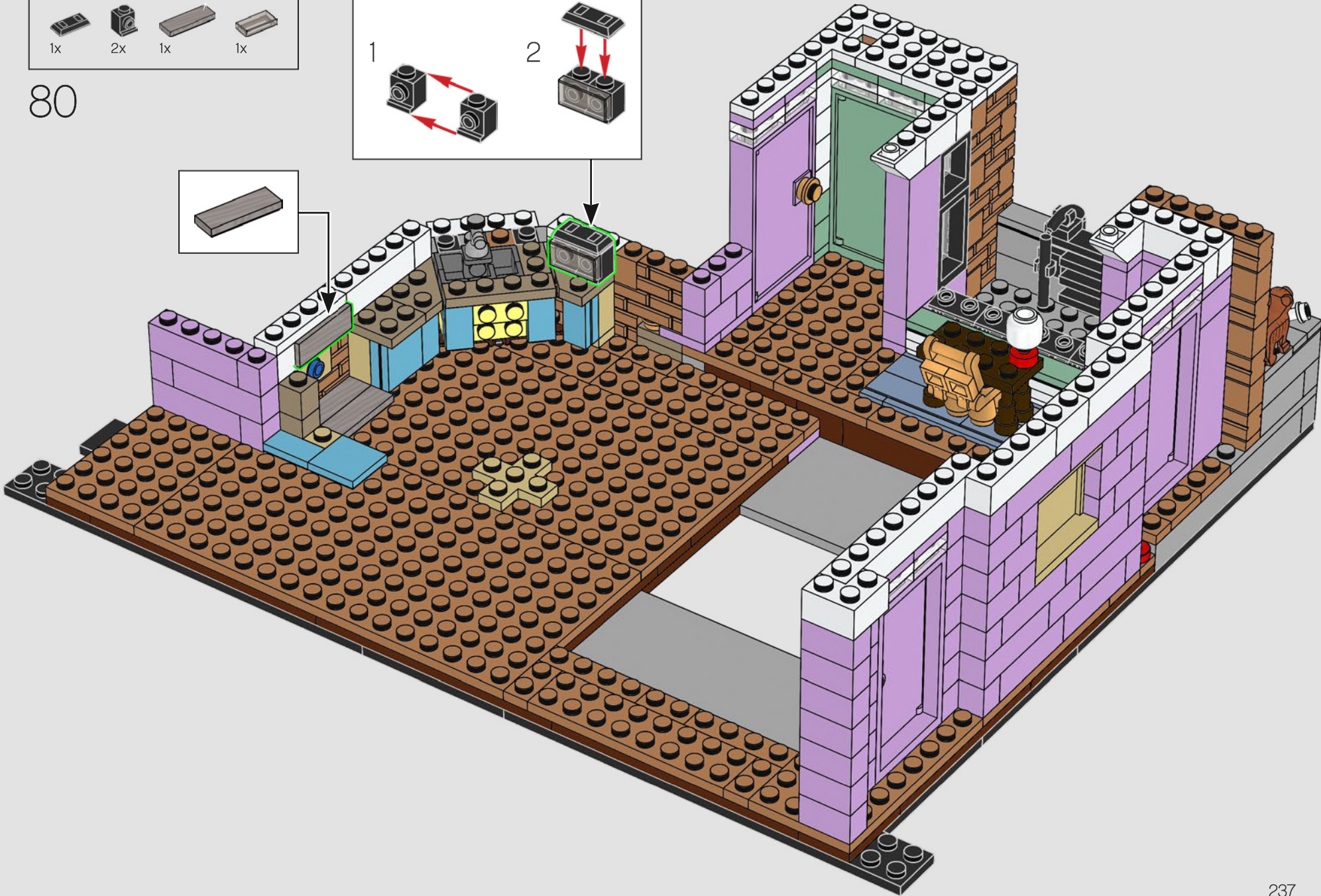
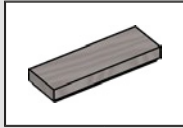
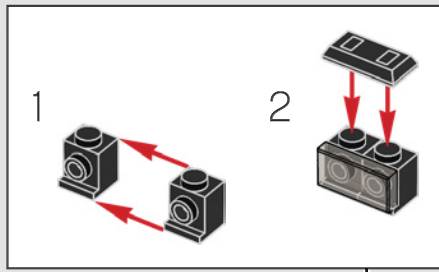

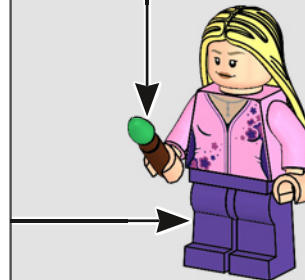
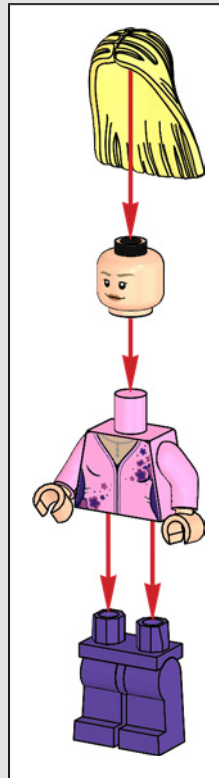
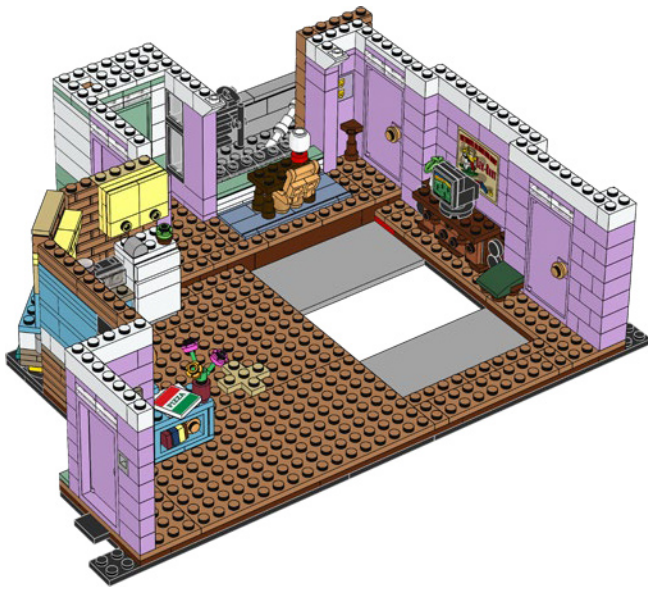
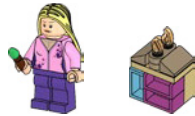
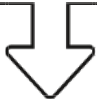

Phoebe's colorful, handmade dollhouse... which accidentally burned down!

La maison de poupée de Phoebe colorée et faite à la main... qui a accidentellement été brûlée !

La colorida casa de muñecas hecha a mano de Phoebe... ¡que terminó reducida a cenizas por accidente!



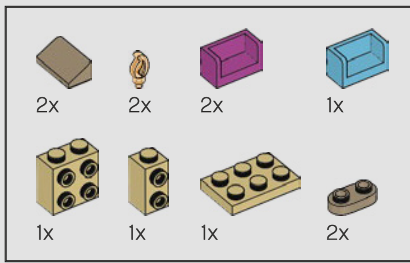

1

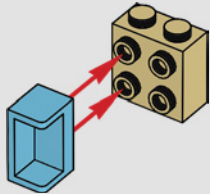

2

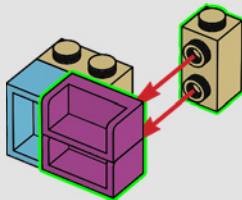

3

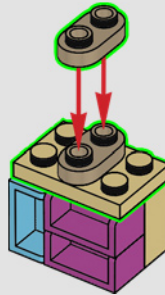

4

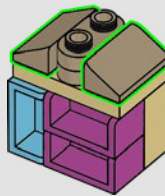

5

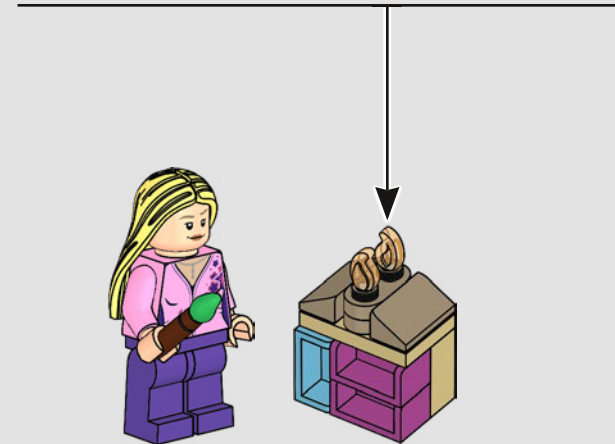
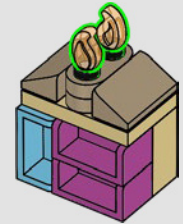

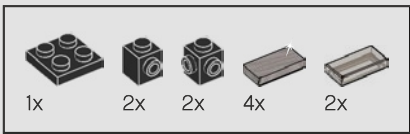

81

1

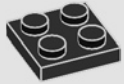

2

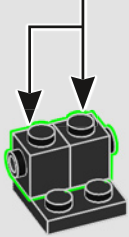

3

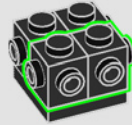

4

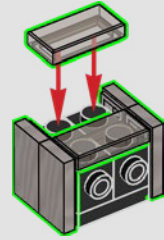

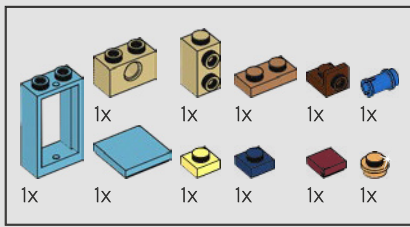

82

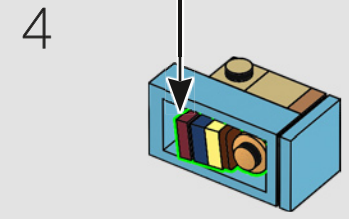
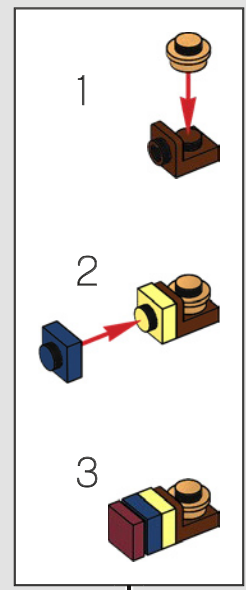
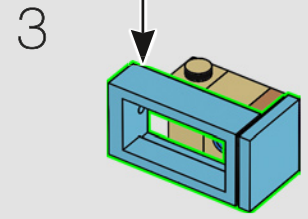
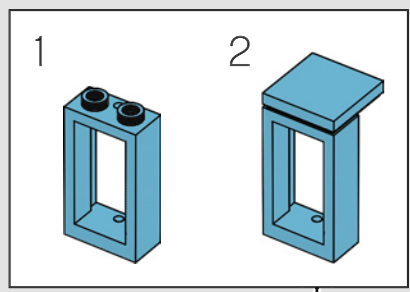
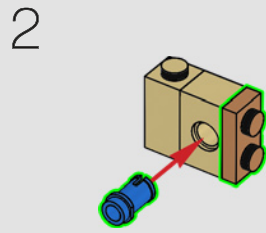
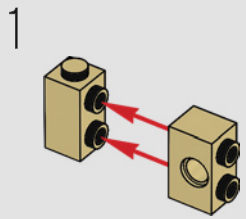

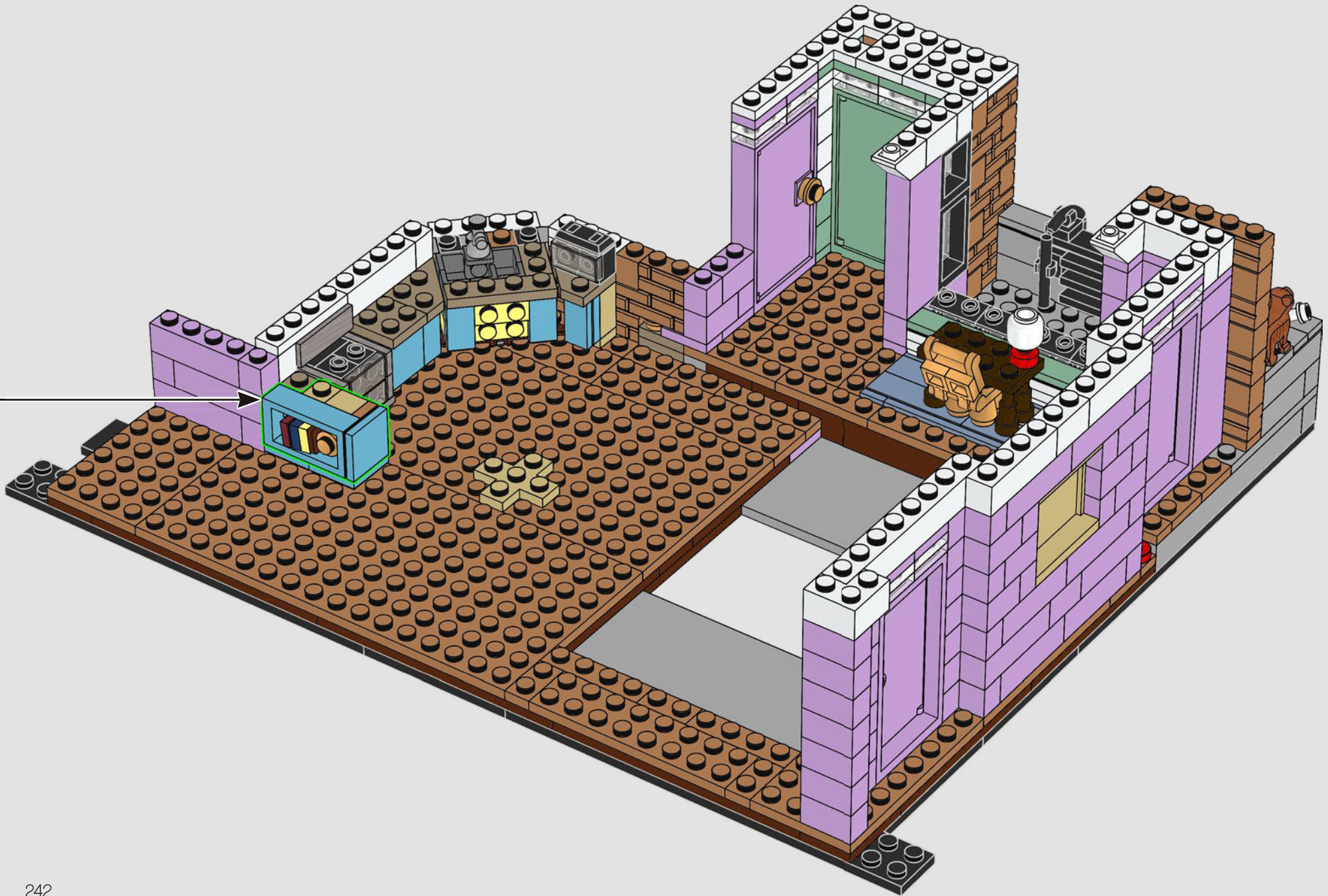

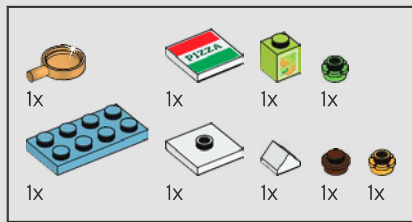

83

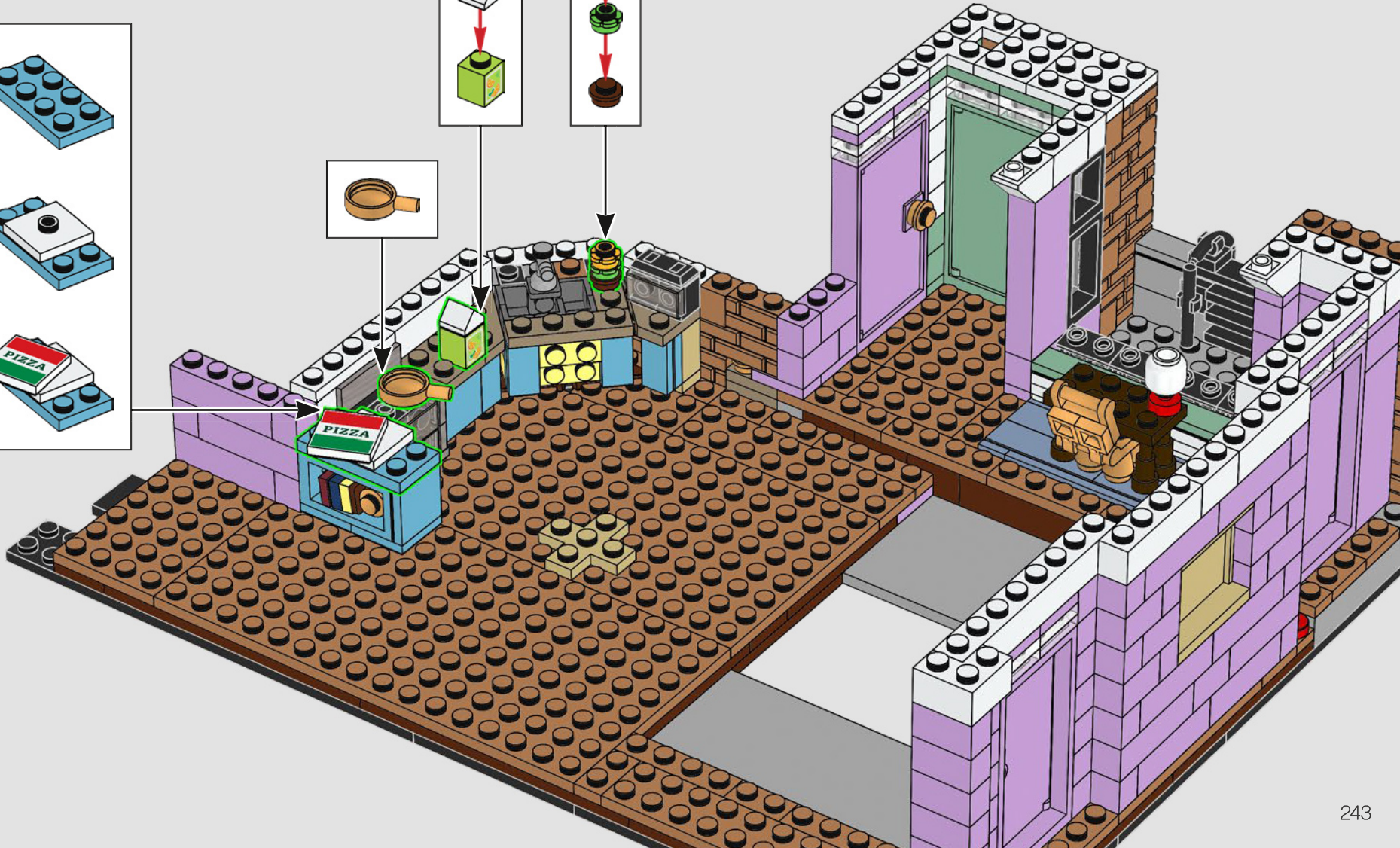
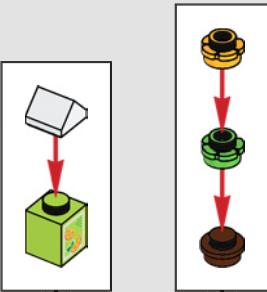
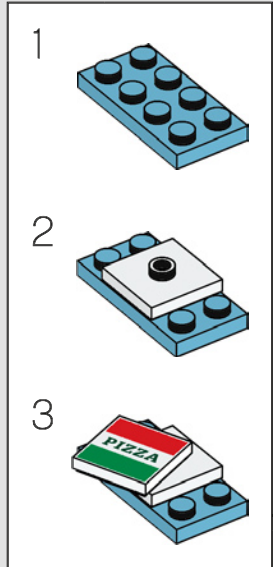

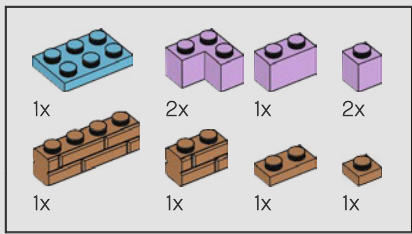

84

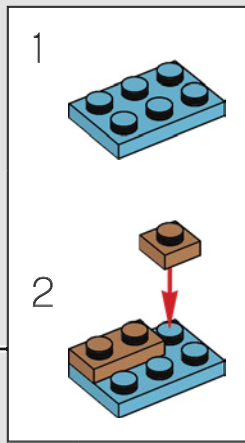

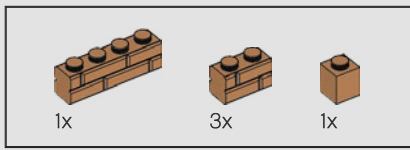

85

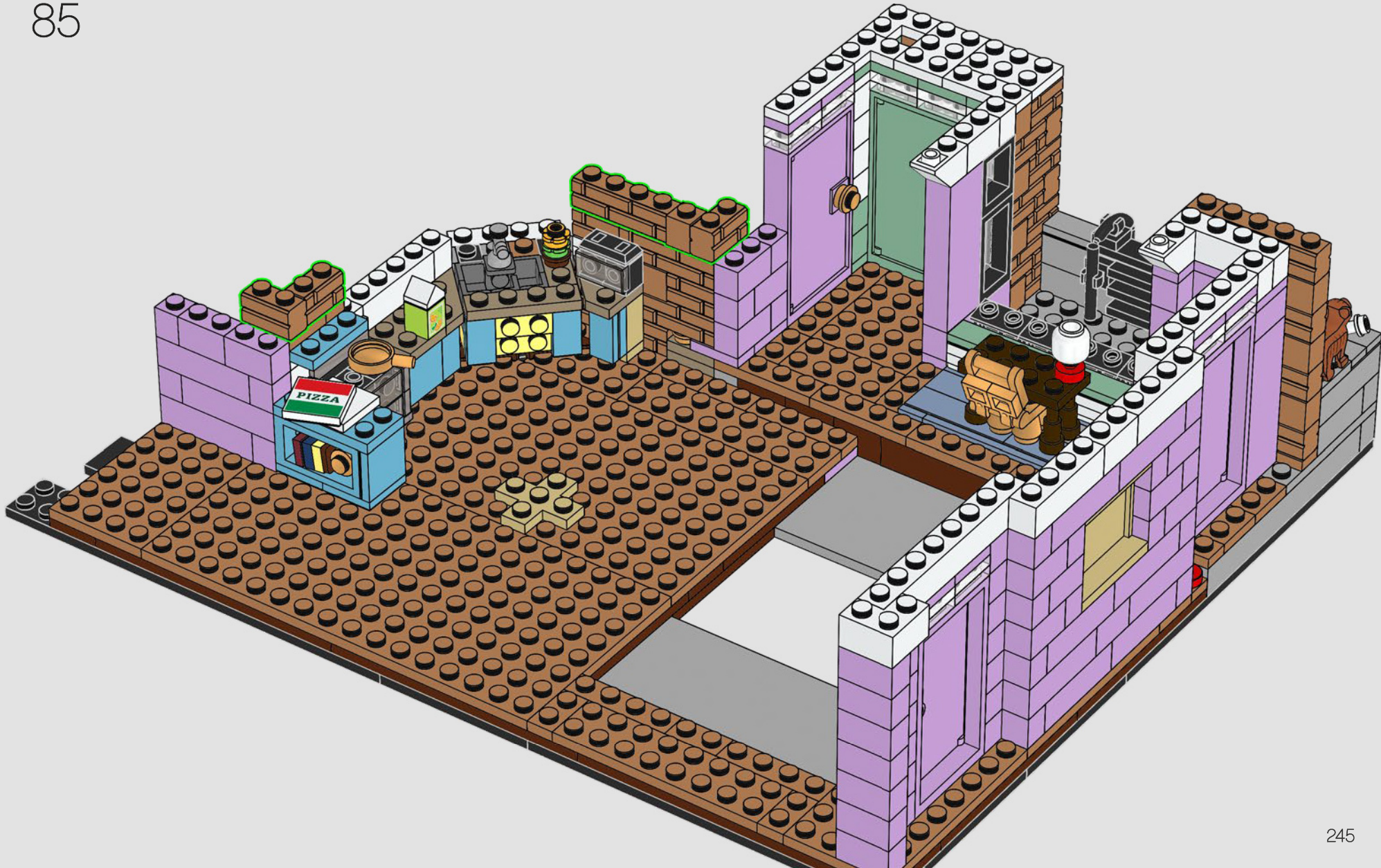

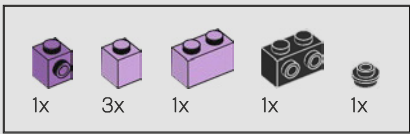

86

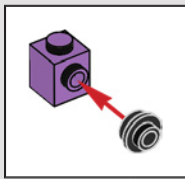

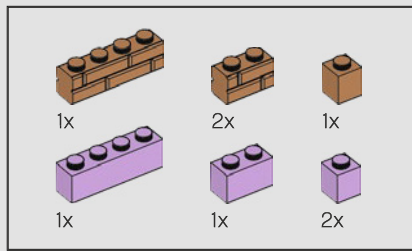

87



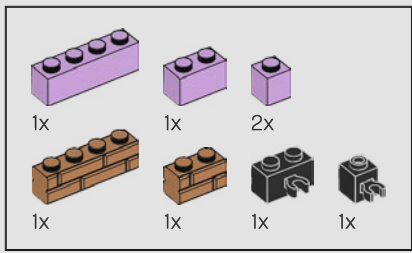

88



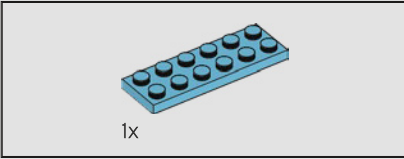
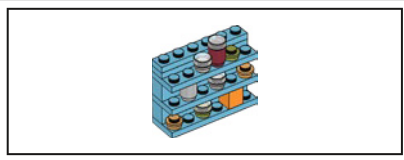

1x

89

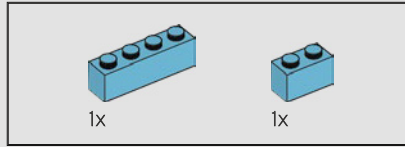
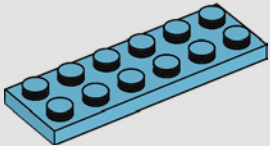

90

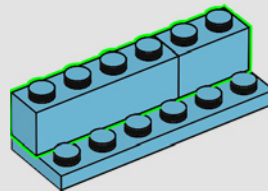

91

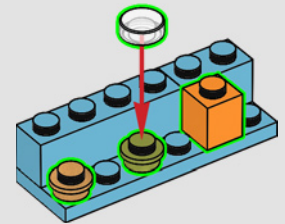

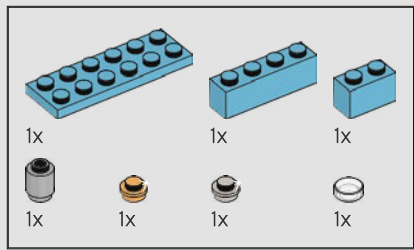

92

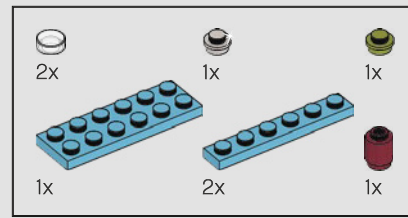
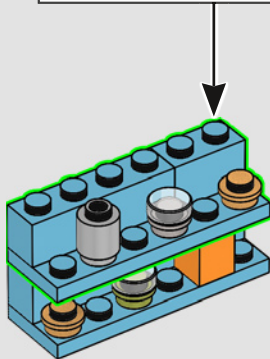
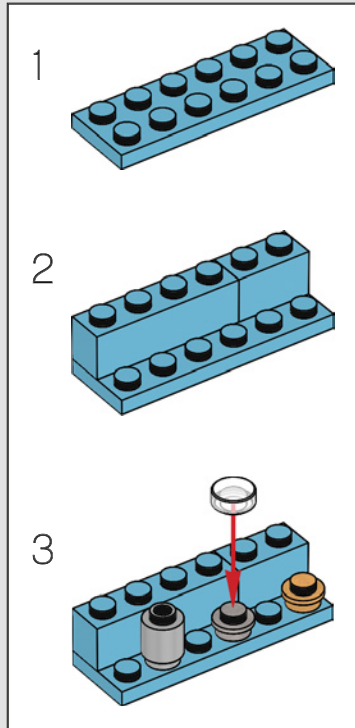

93

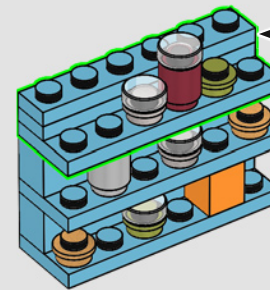
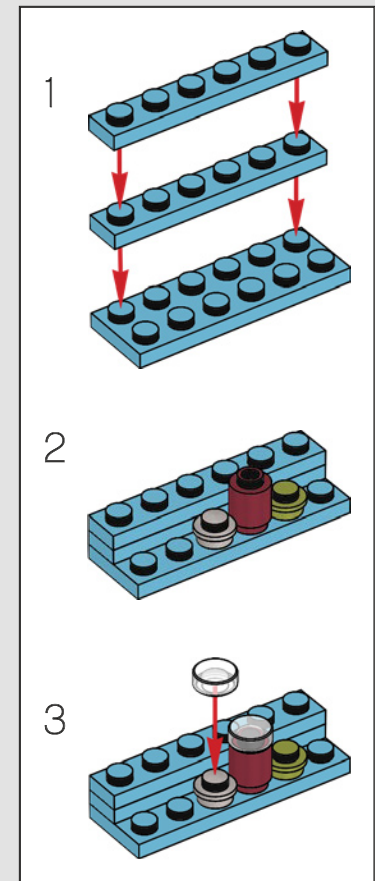

94

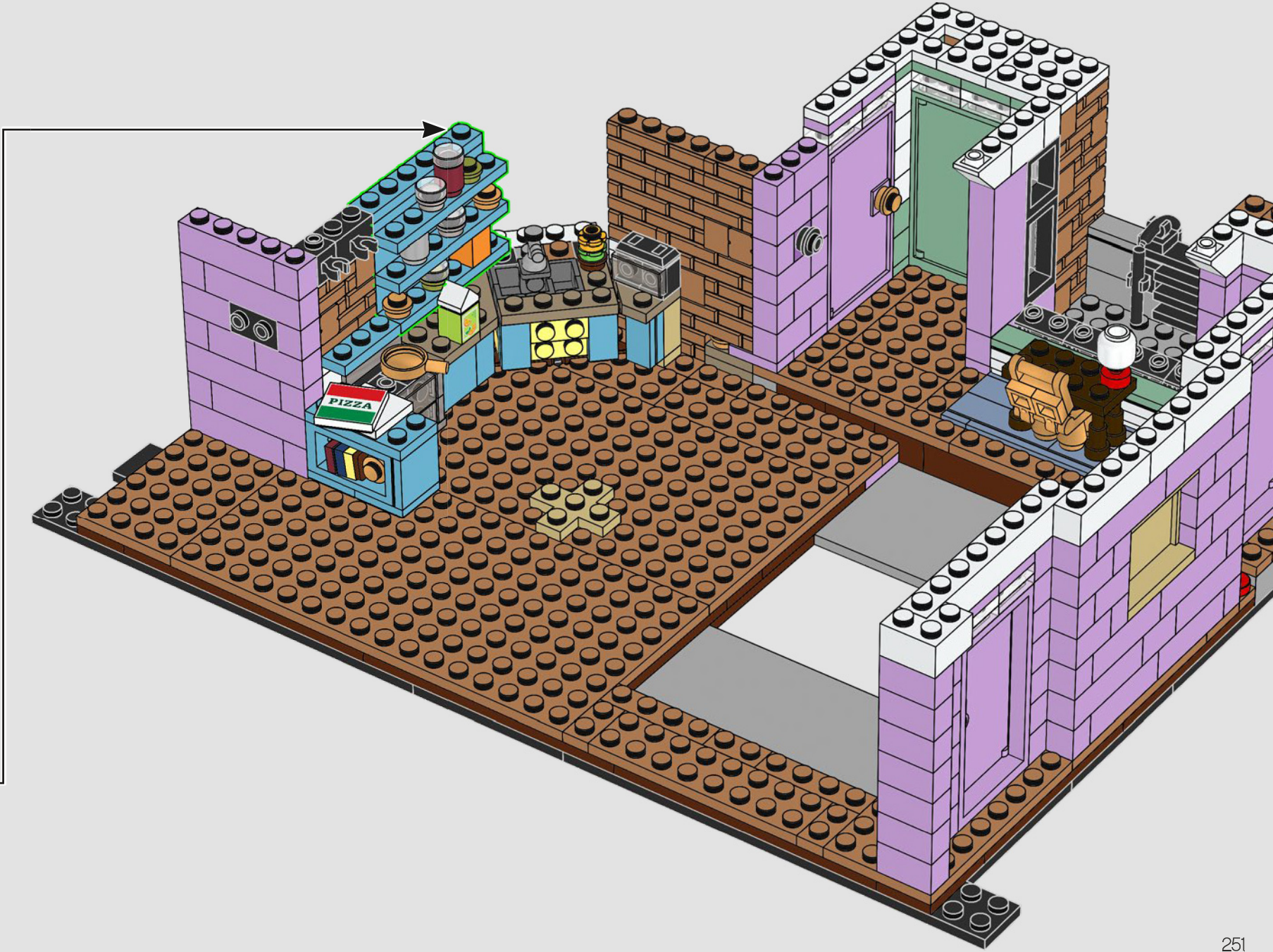

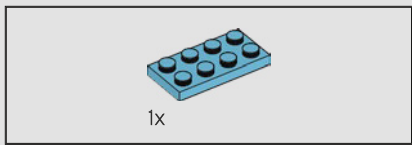

95

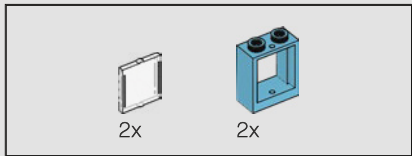
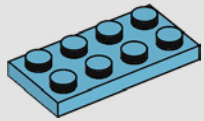

96

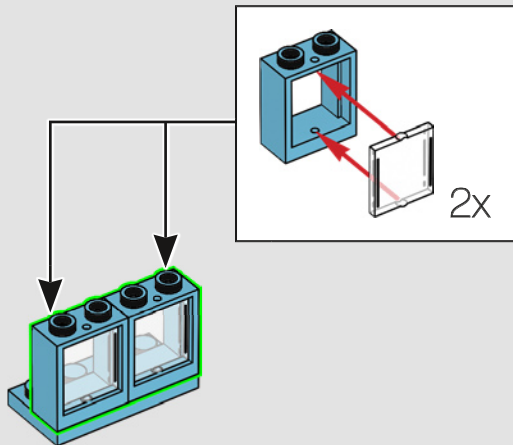

97

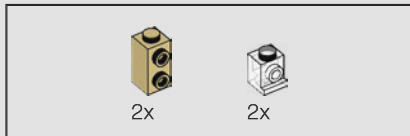
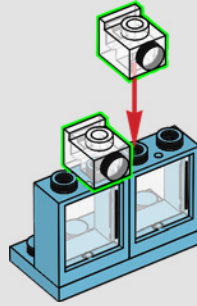

98

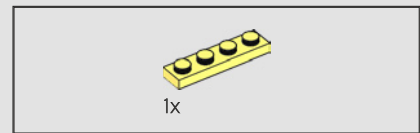
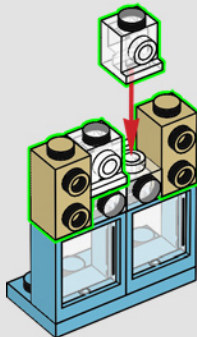

99

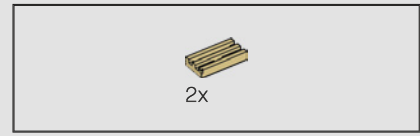
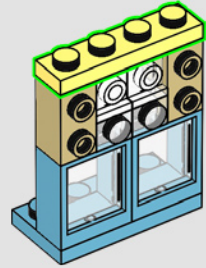

100

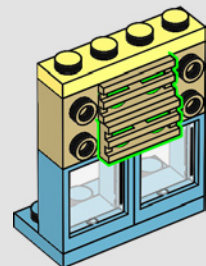

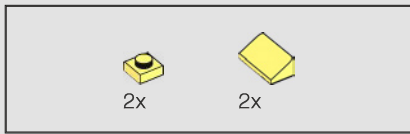

101

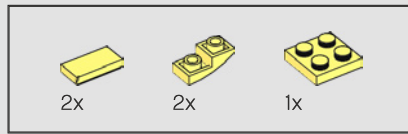
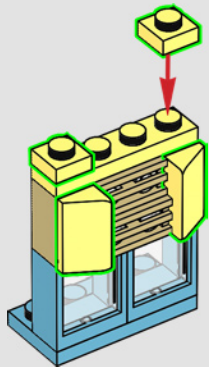

102

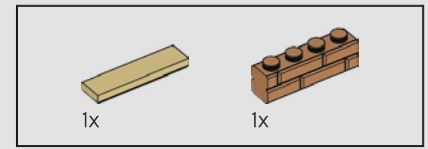
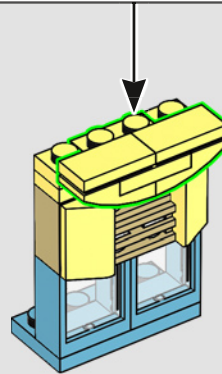
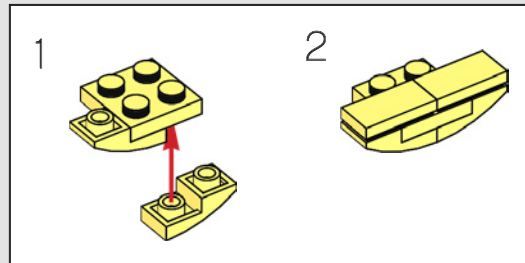

103

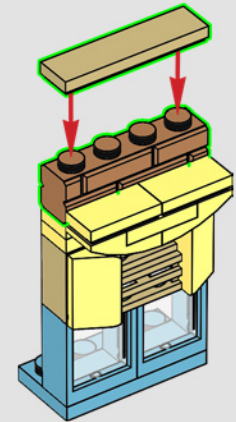

104

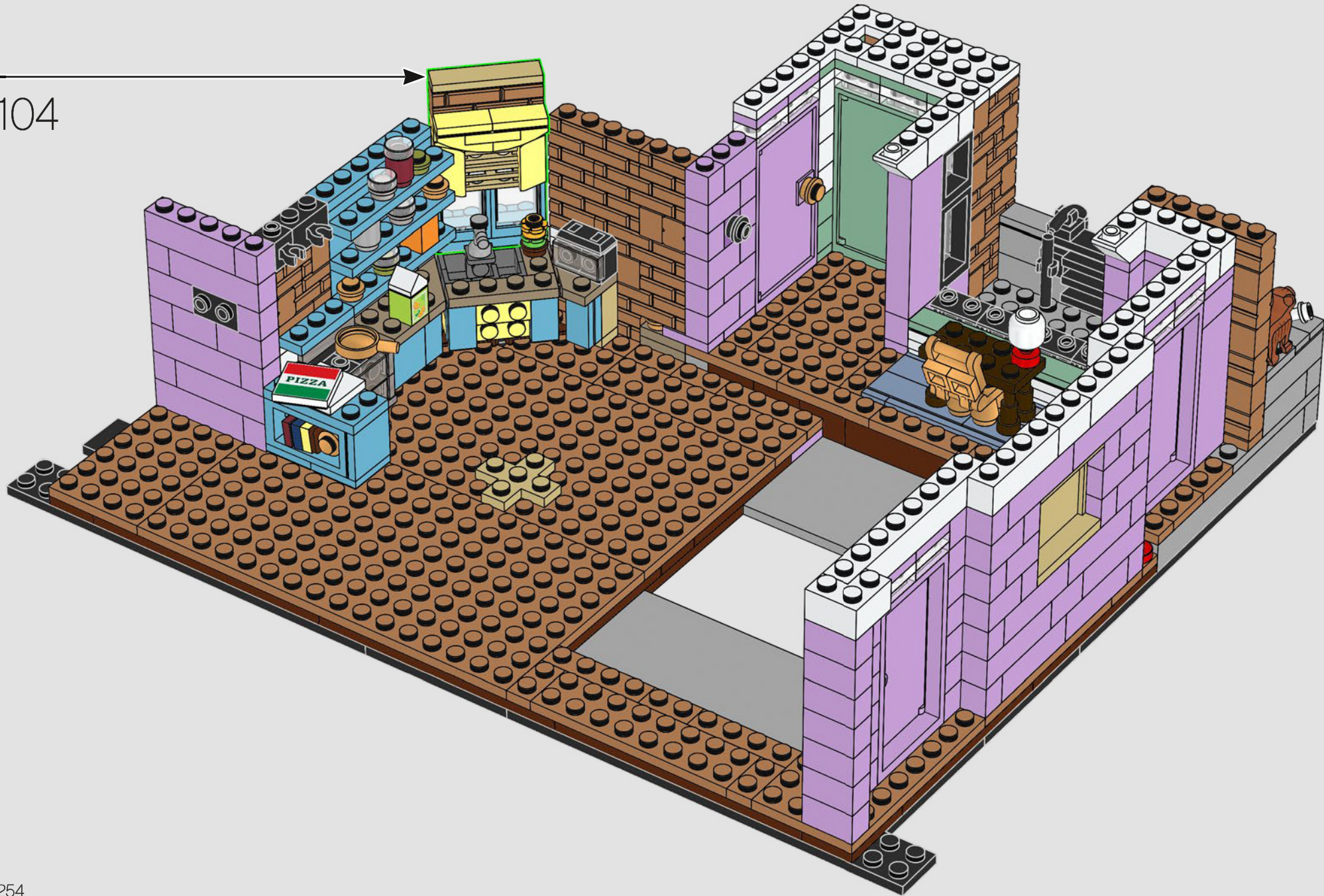

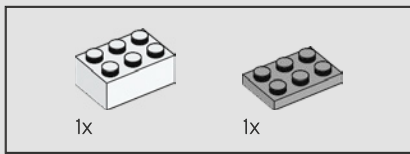

105

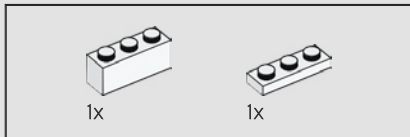
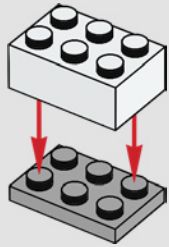

106

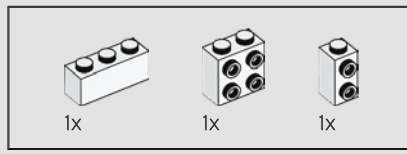
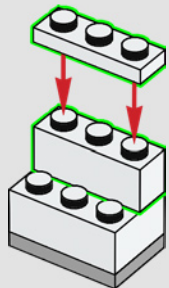

107

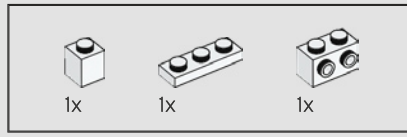
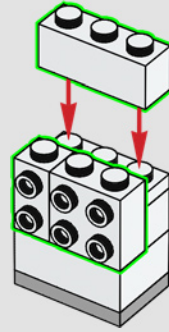

108

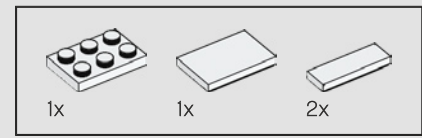
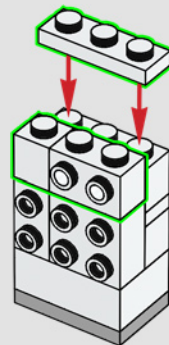

109

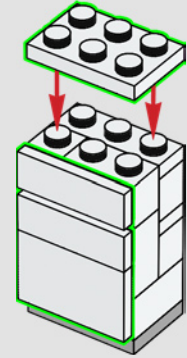

110

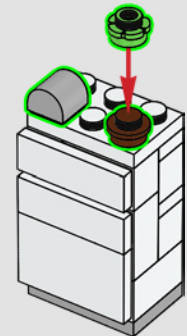

111

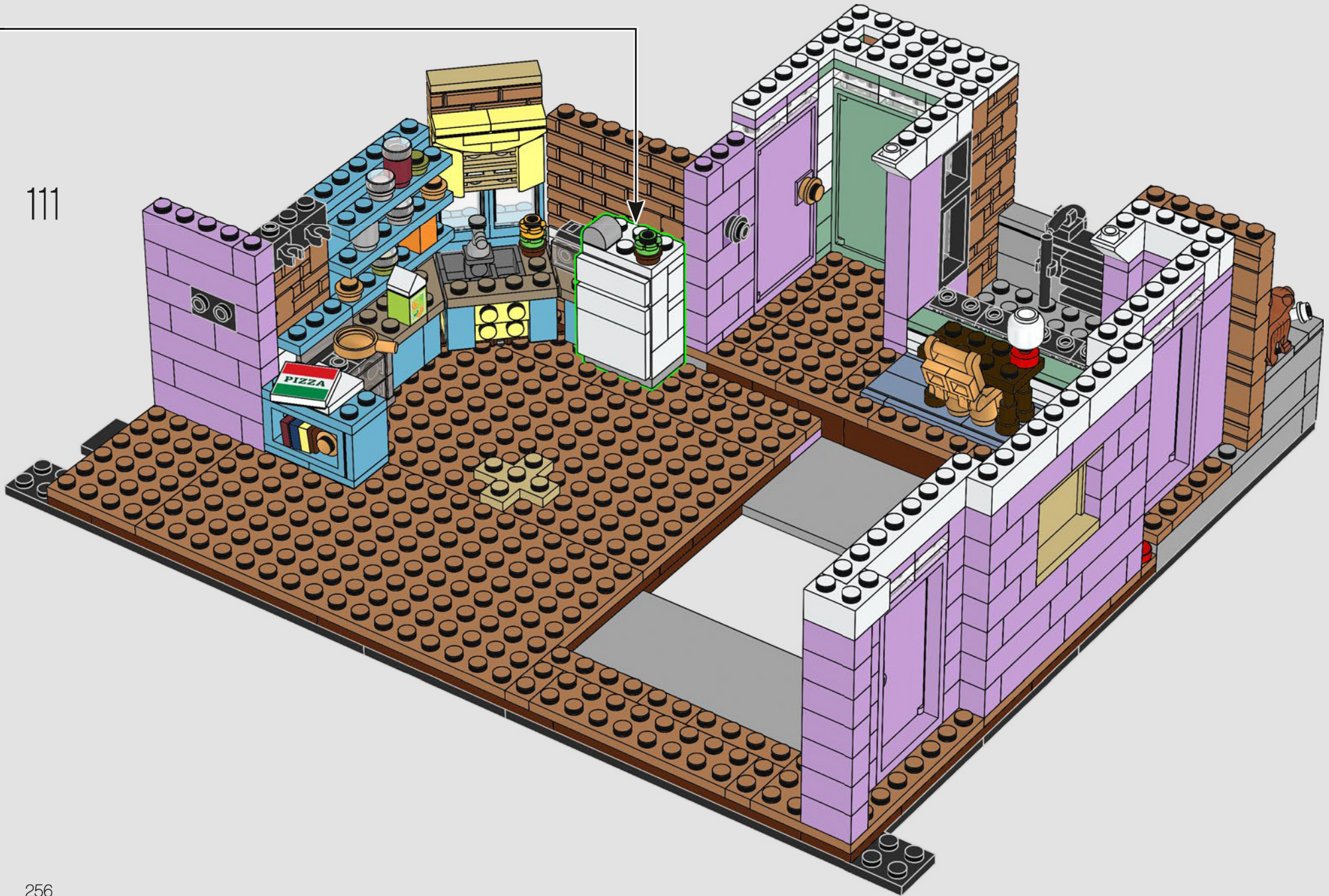

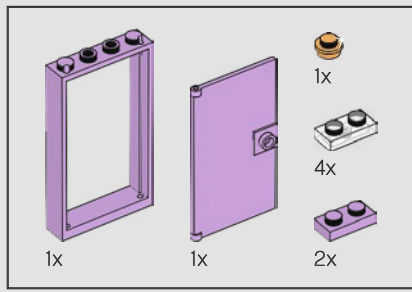

112

1

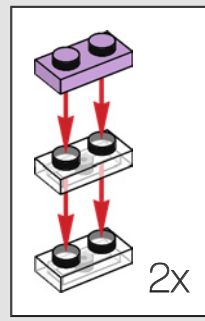
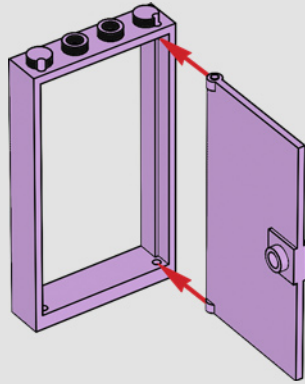

2

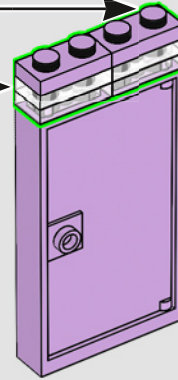

3

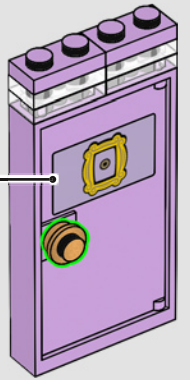

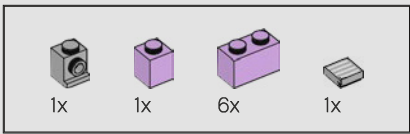

113

1

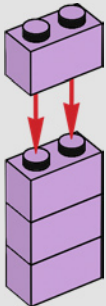

2

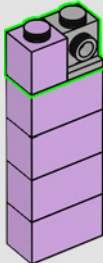

3

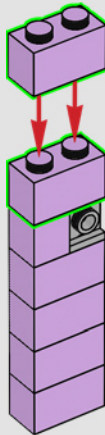

4

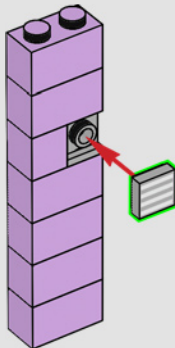

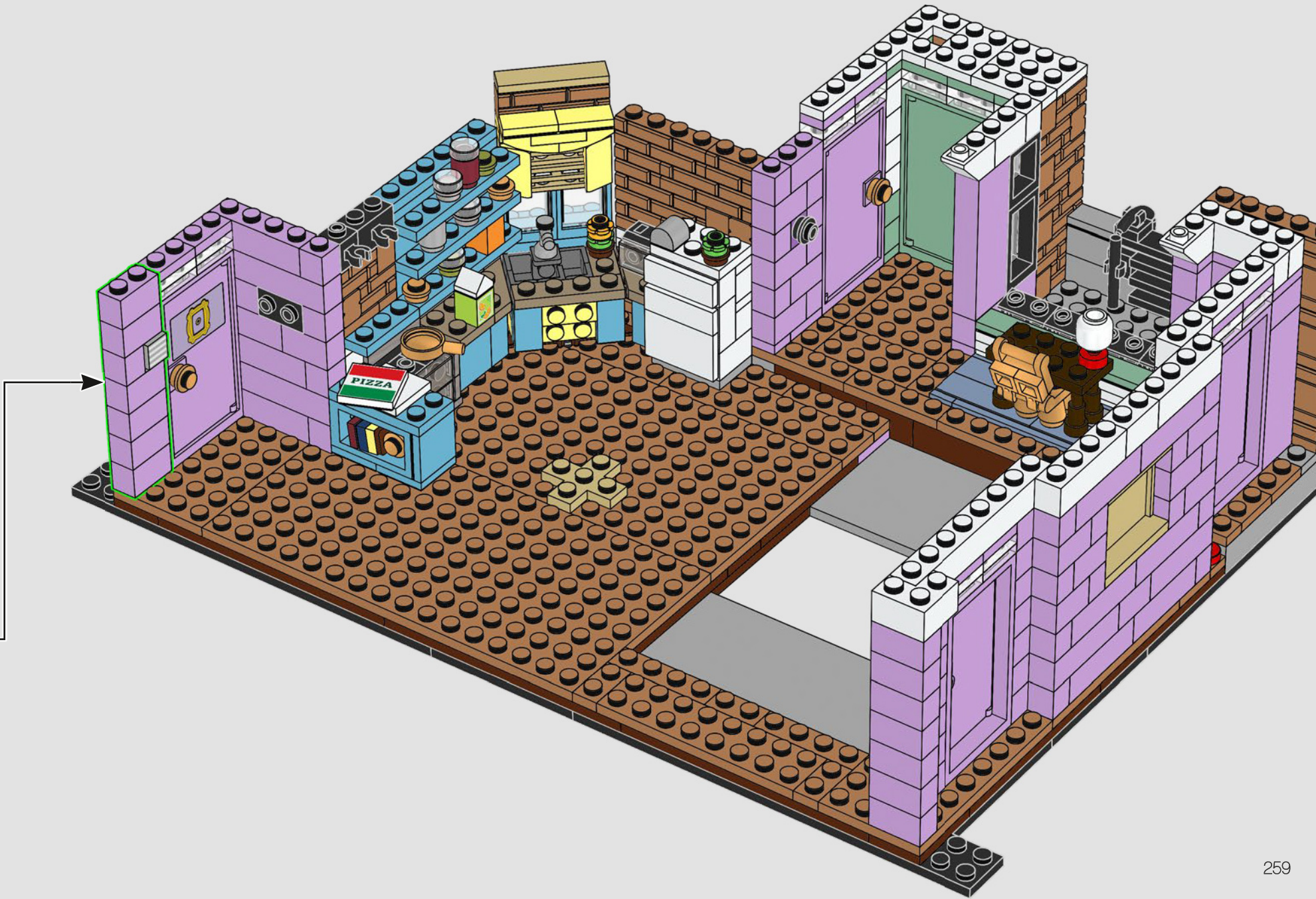

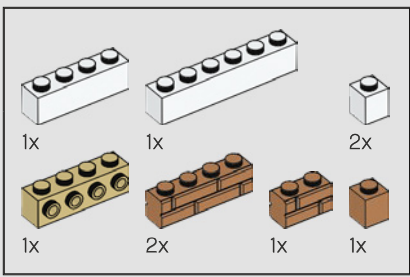

114



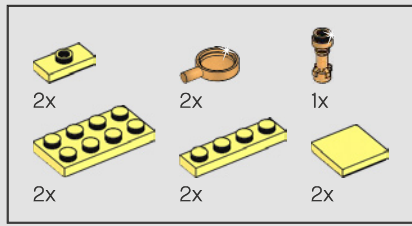

115

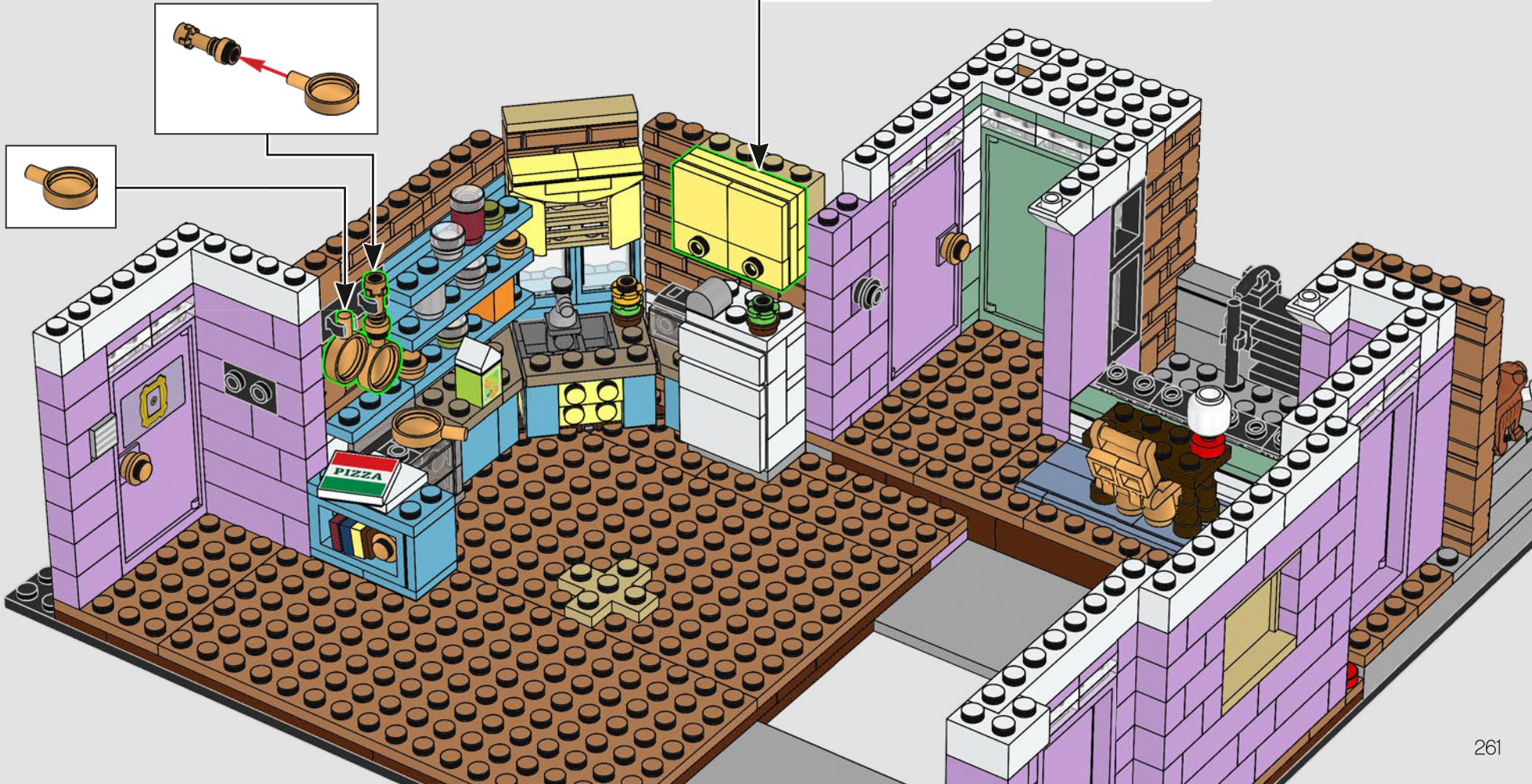
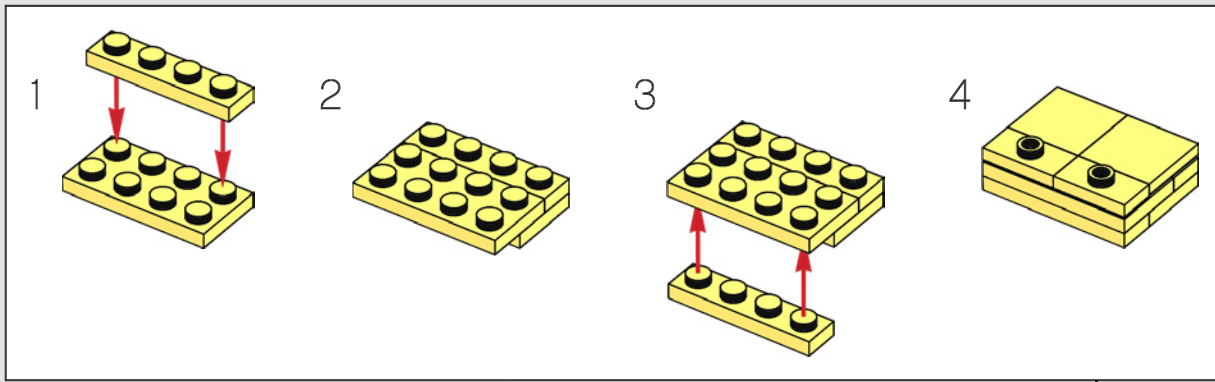



116

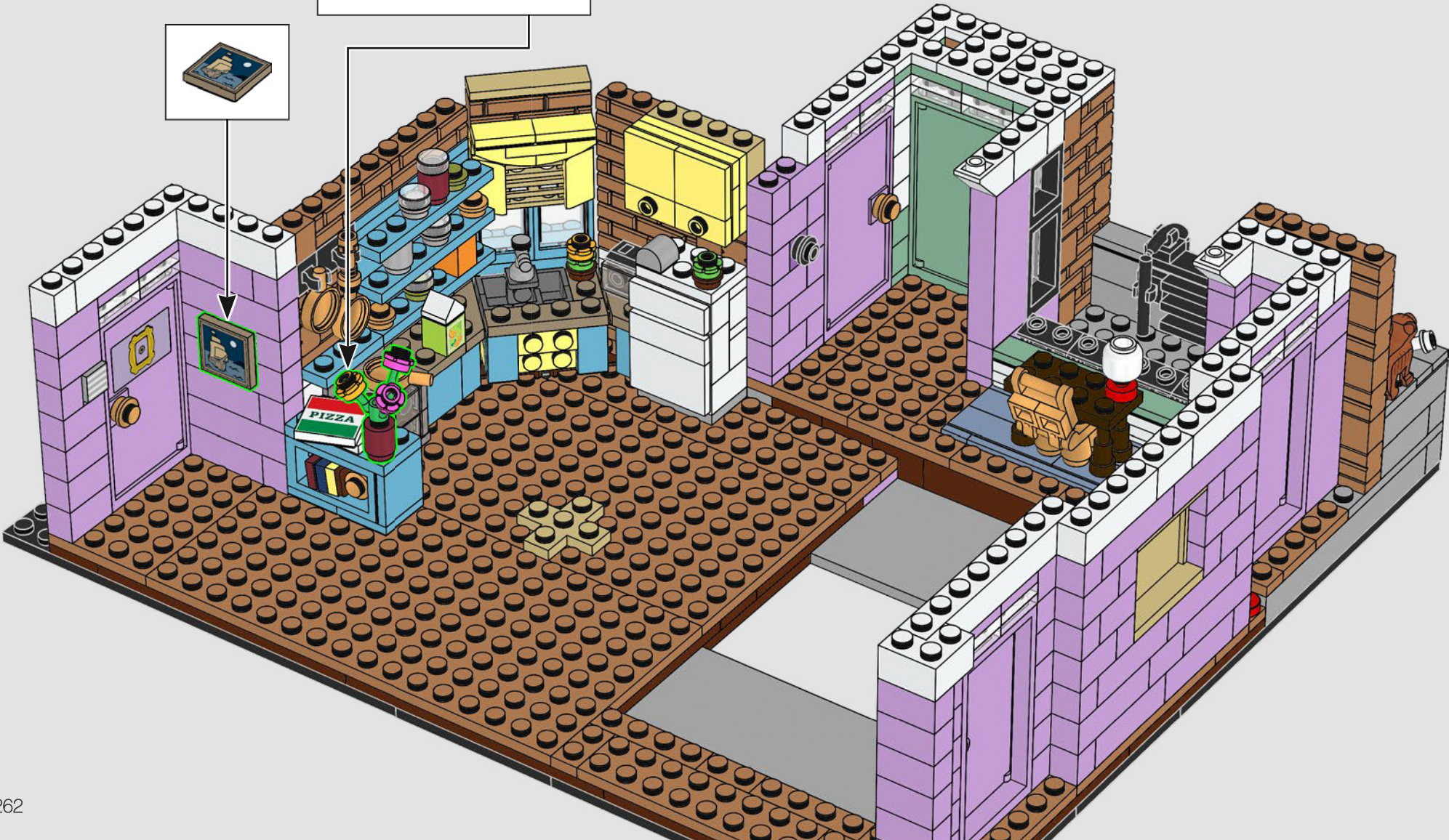
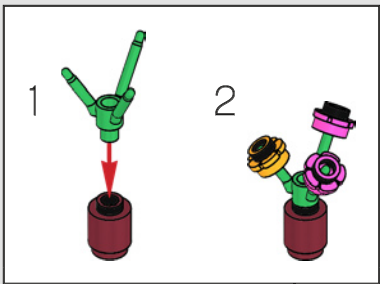

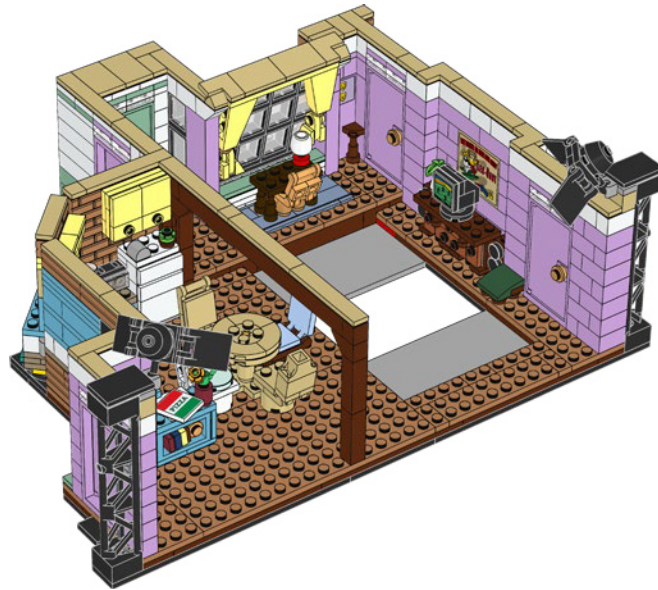
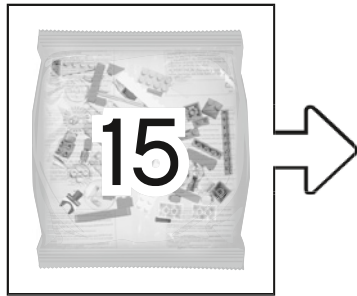

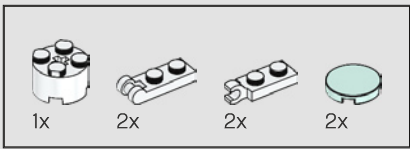

117

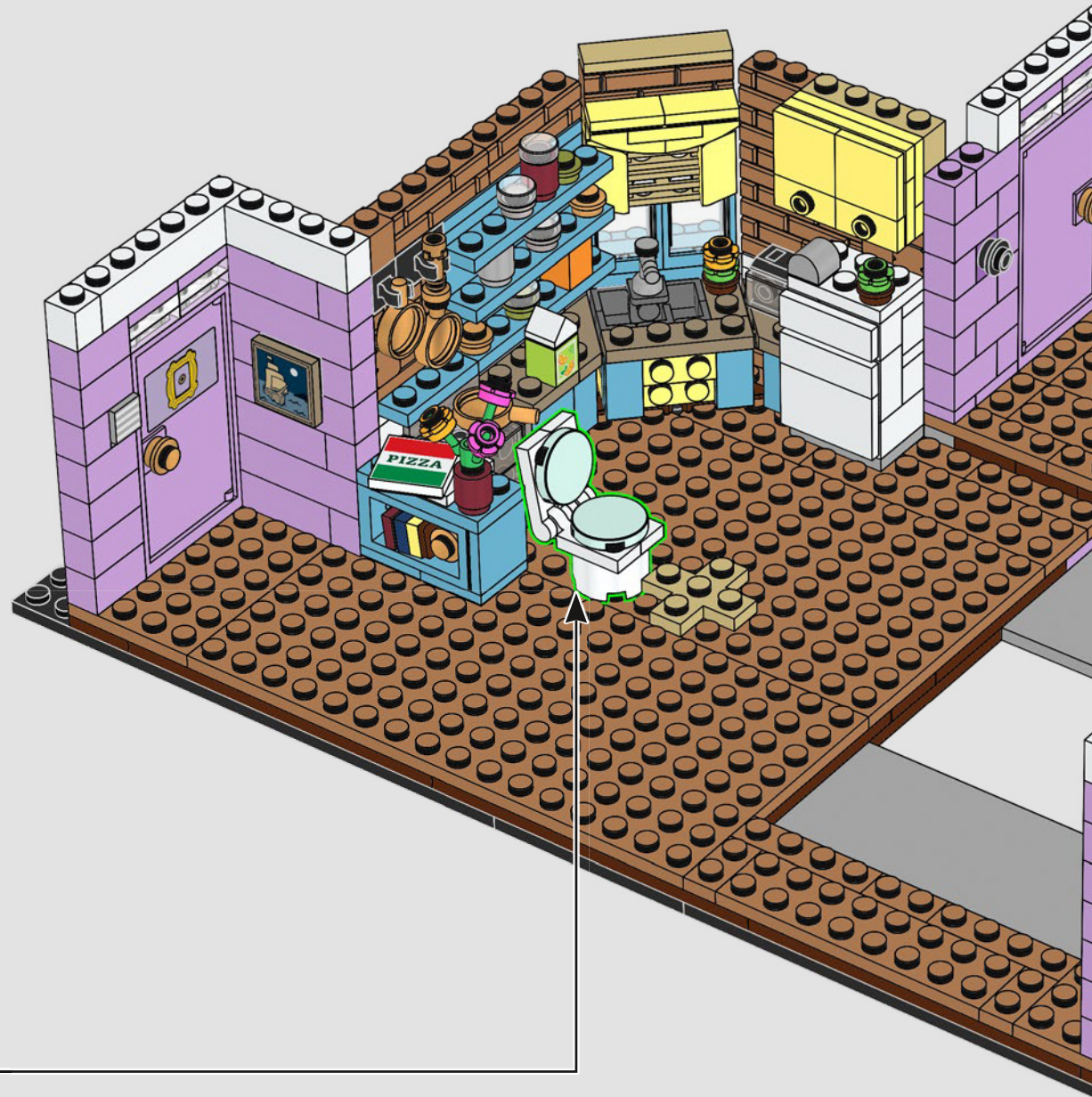
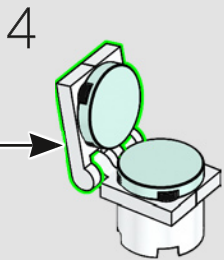
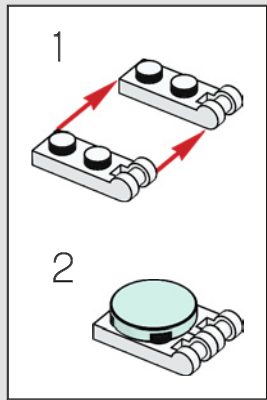
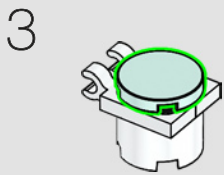
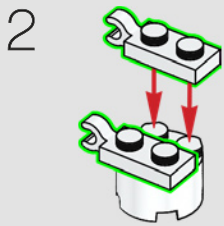
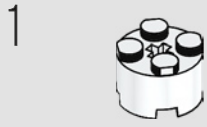

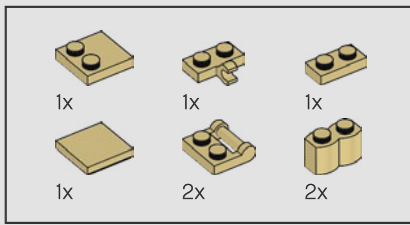

118

1



2

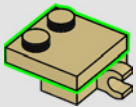

3

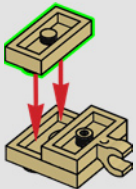

4

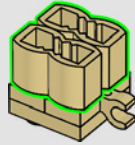

1

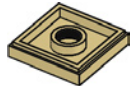

2

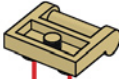

5

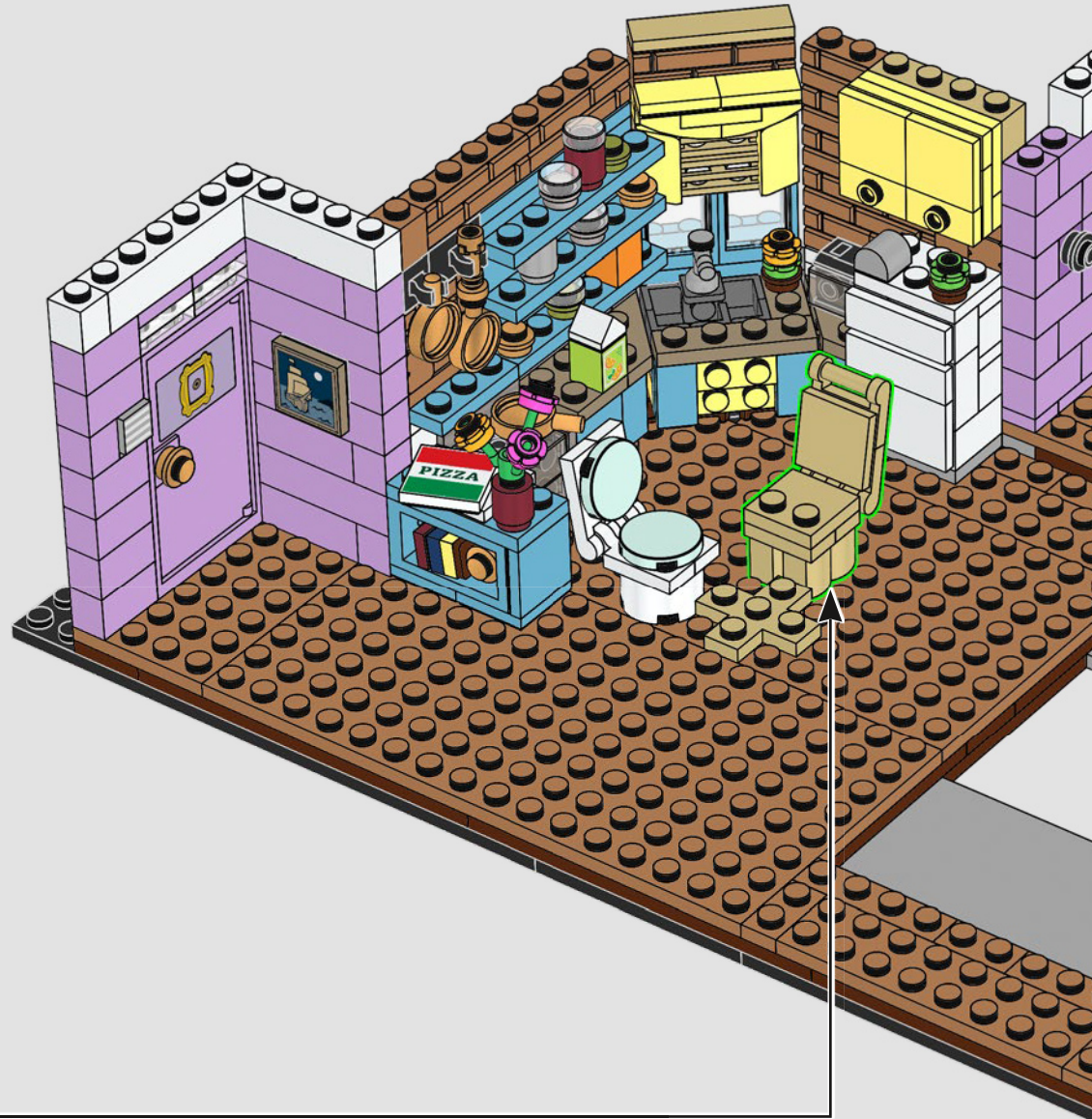
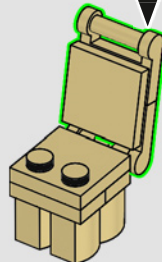

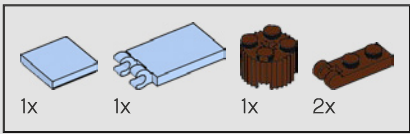

119

1



2



3

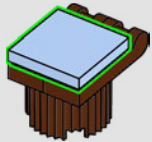

4

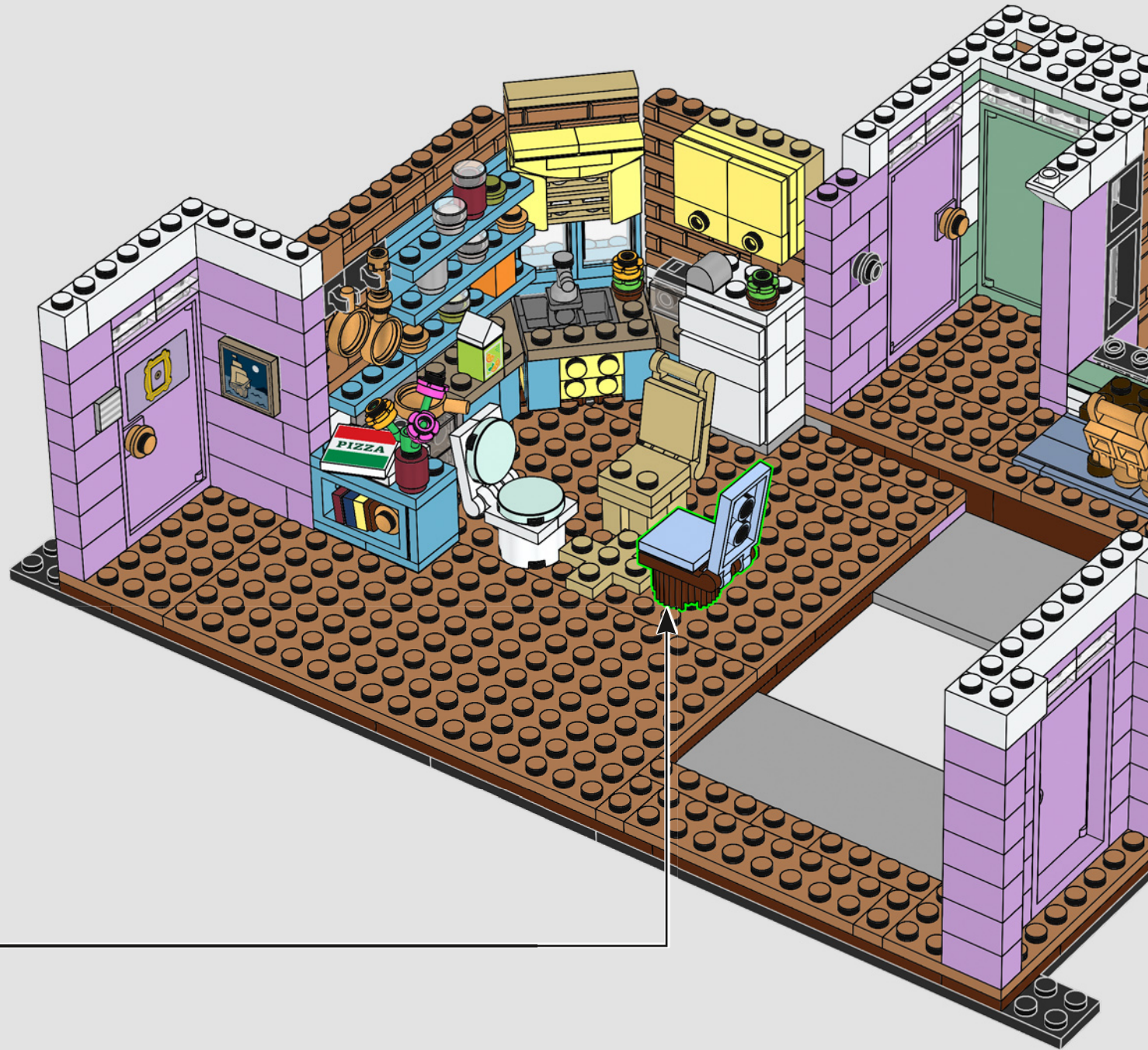
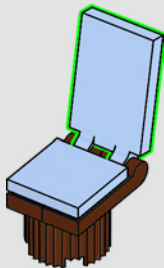

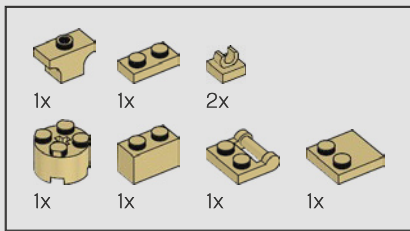

120

1

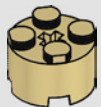

2

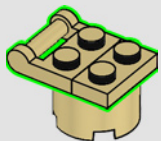

3

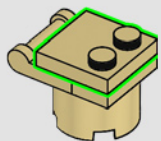

1



2



3

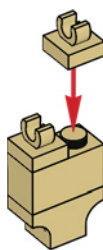

4

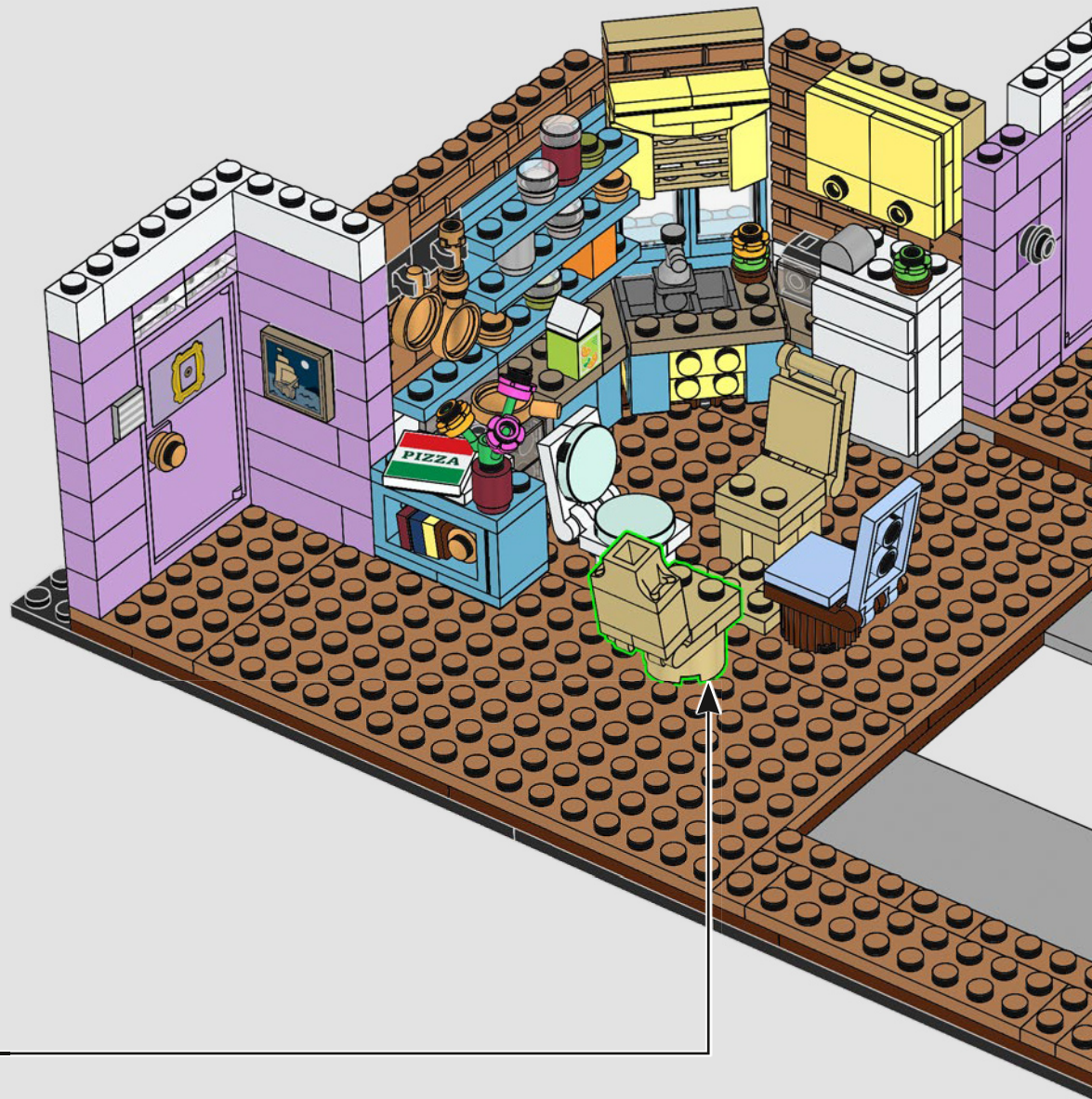
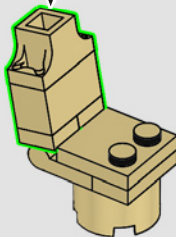

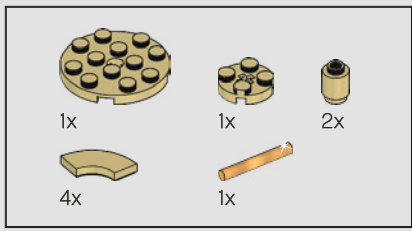

121

1



2

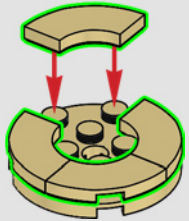

3

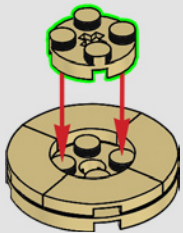

4

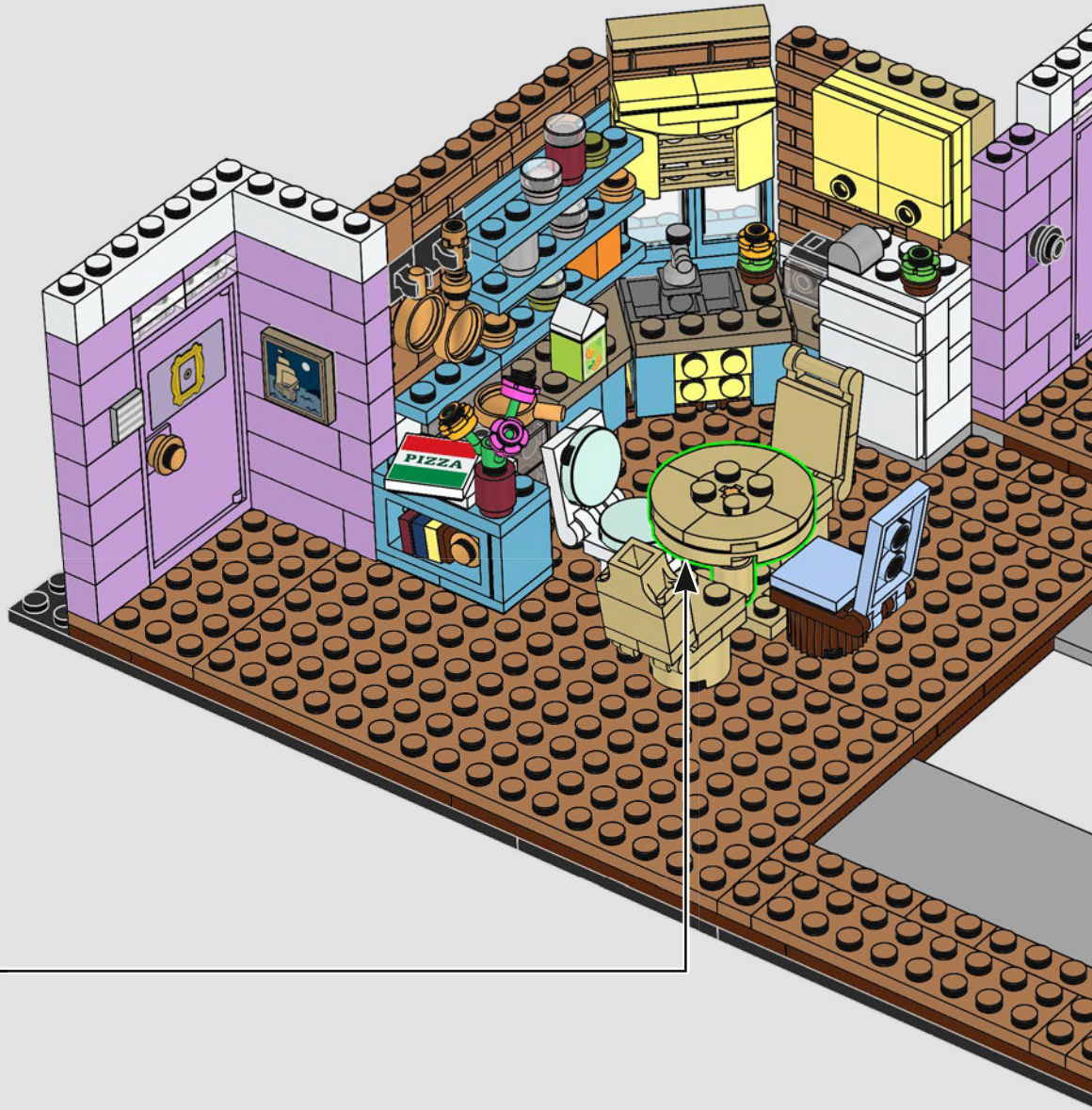
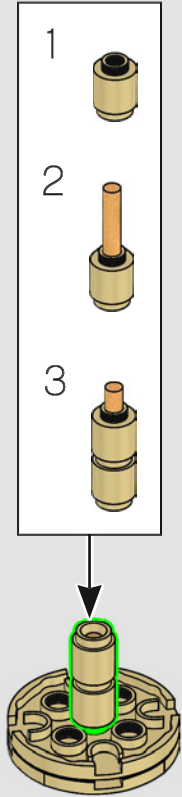

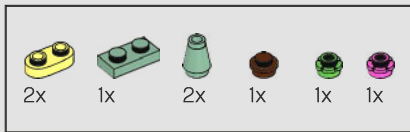

122

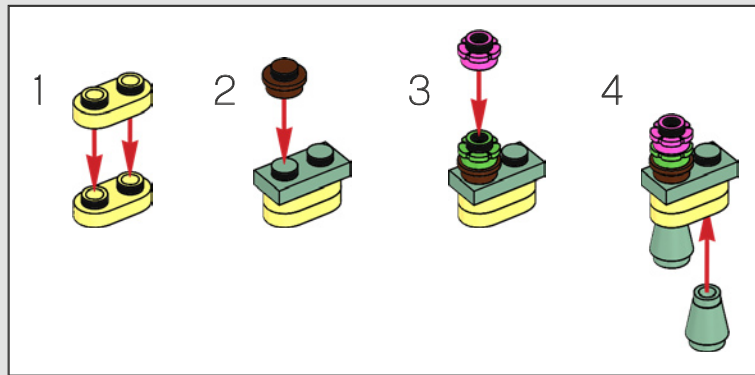

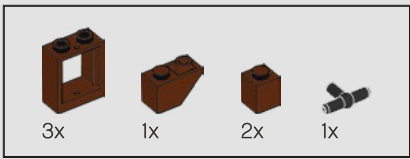

123

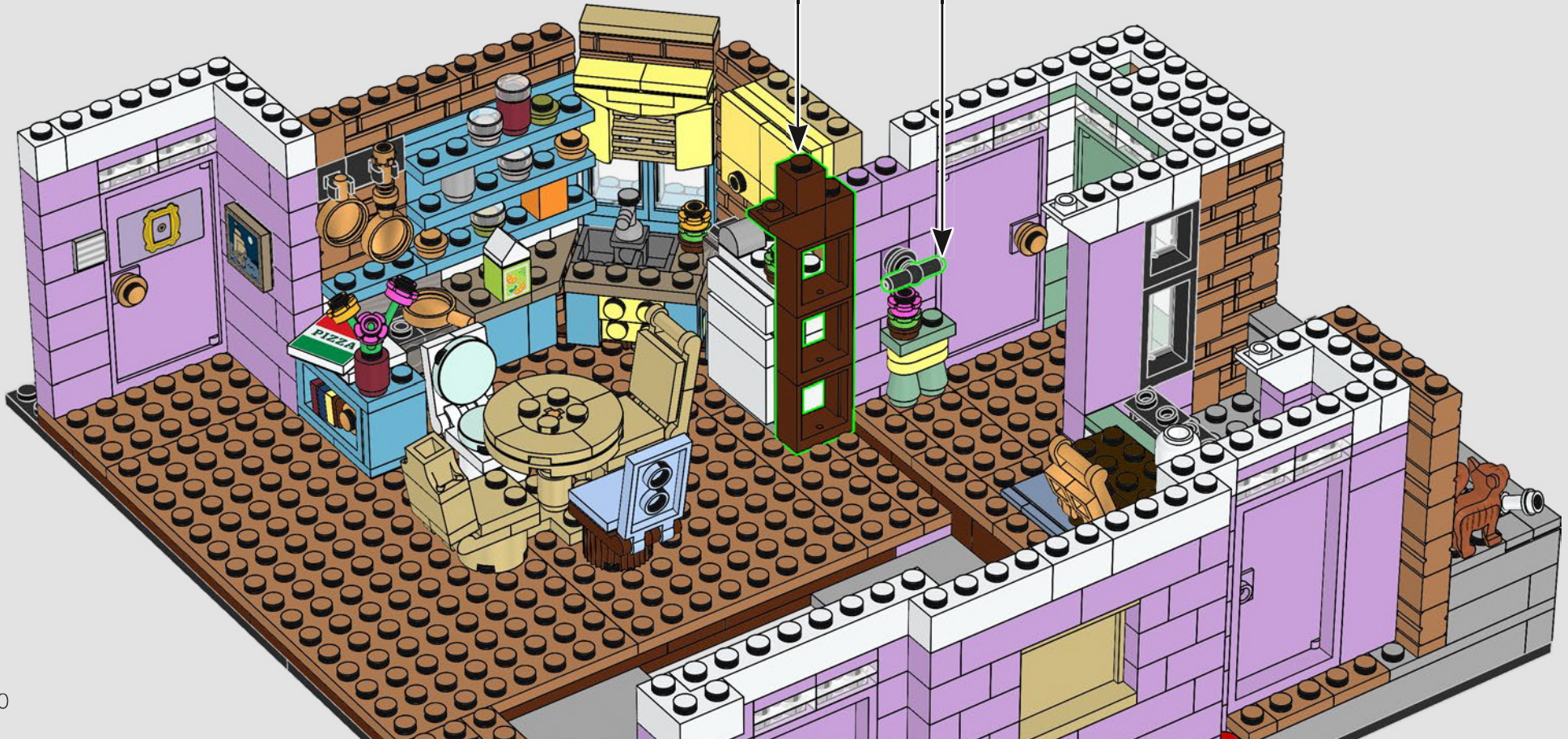
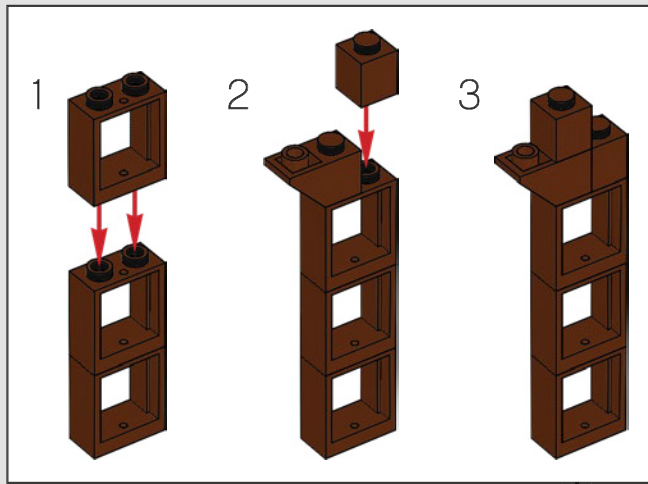

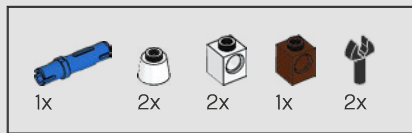

124

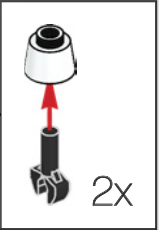
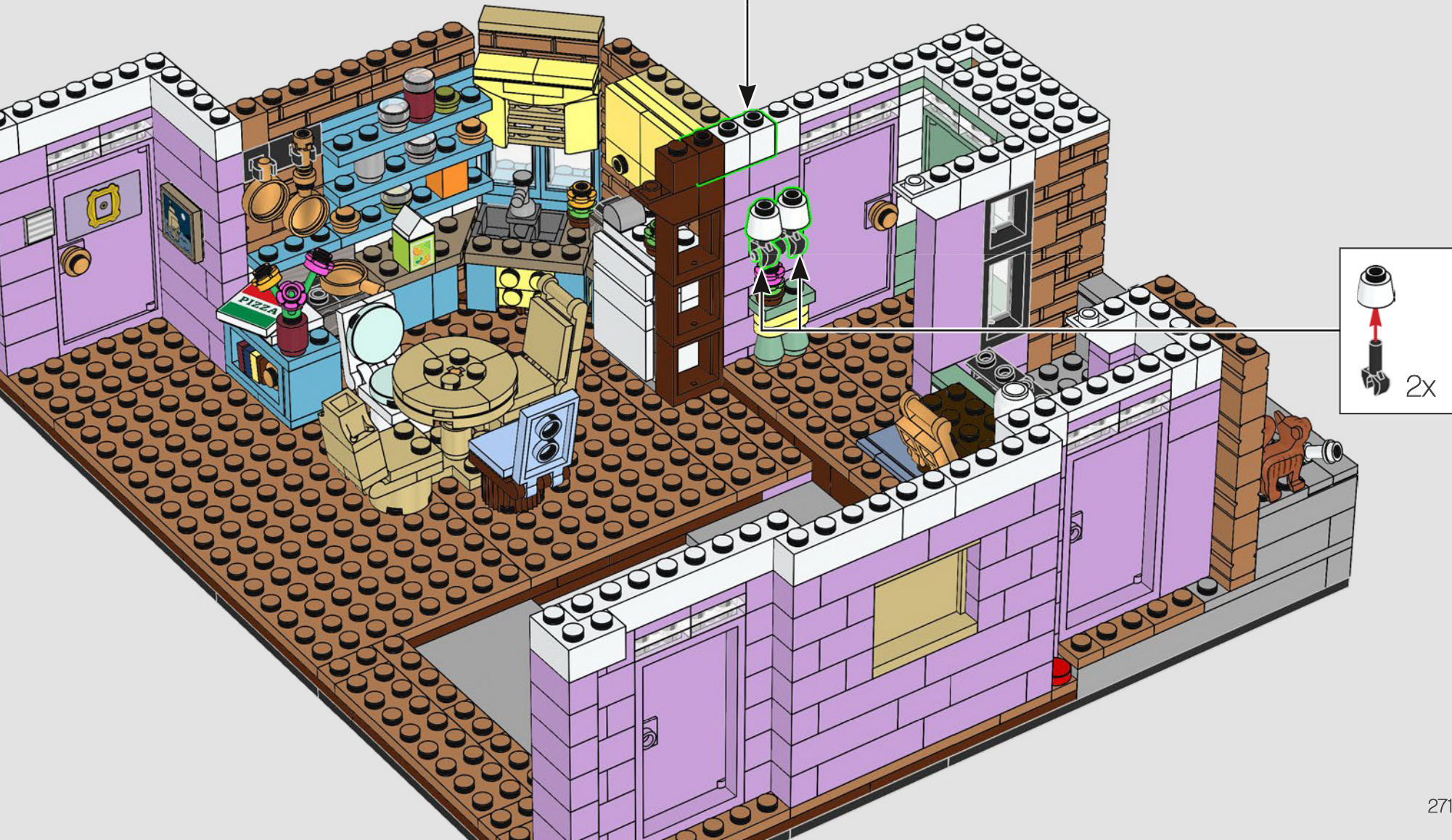
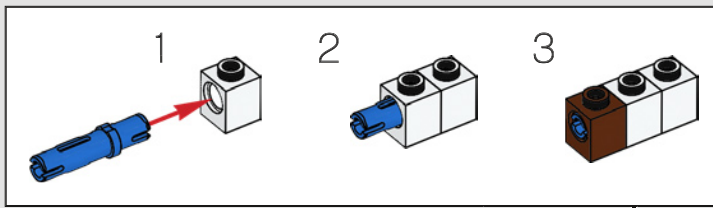

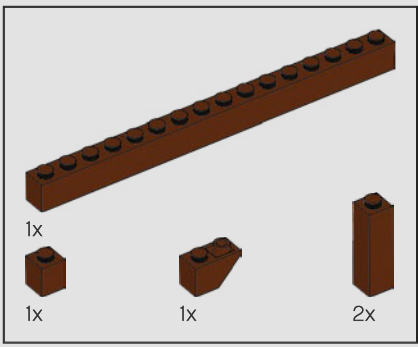

125

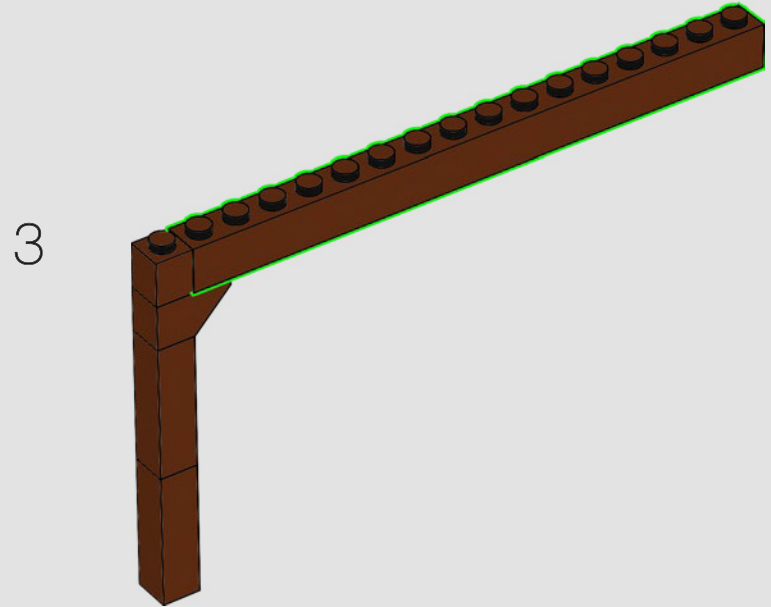
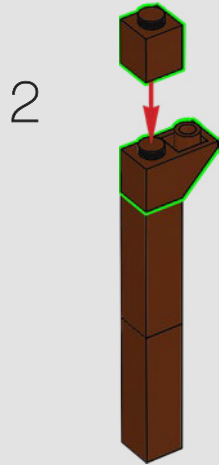
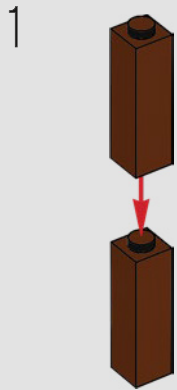



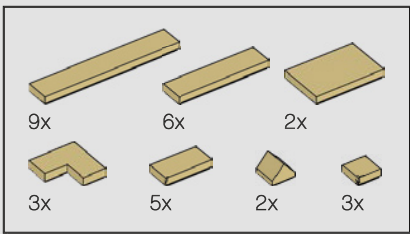

126



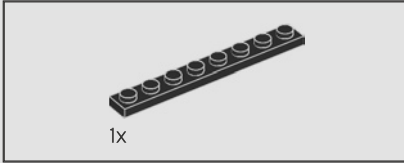
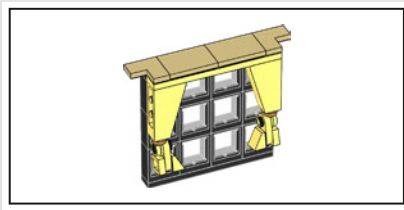

127

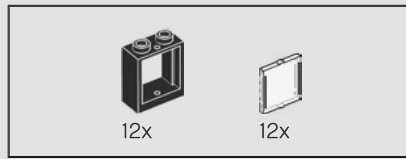
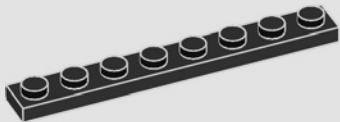

128

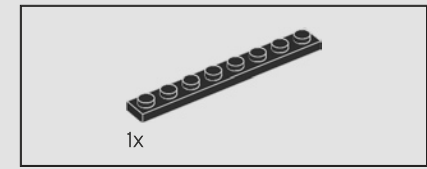
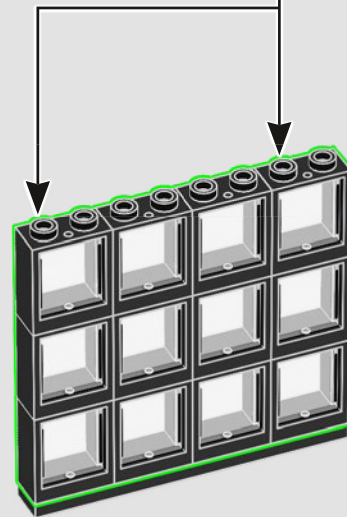
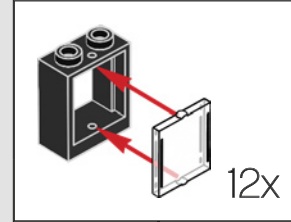

129

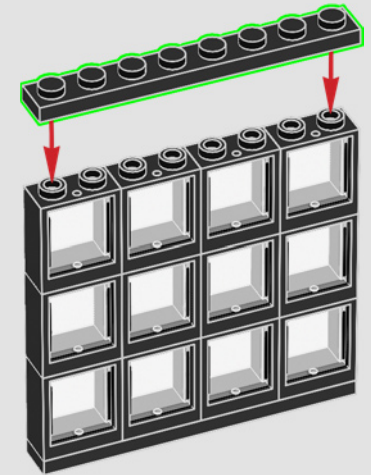

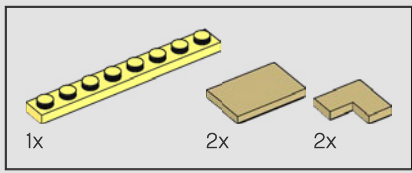

130

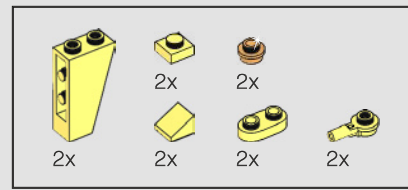
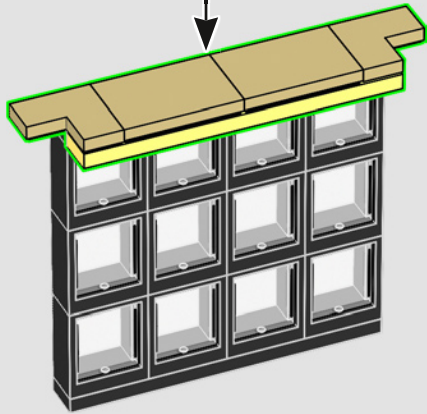
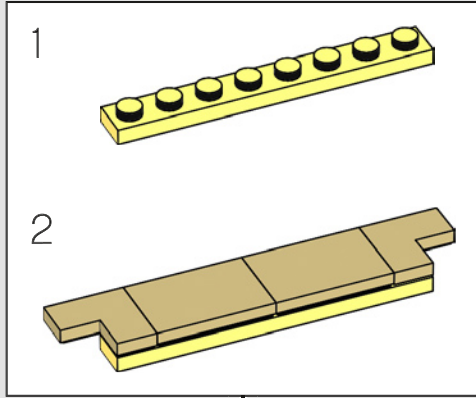

131

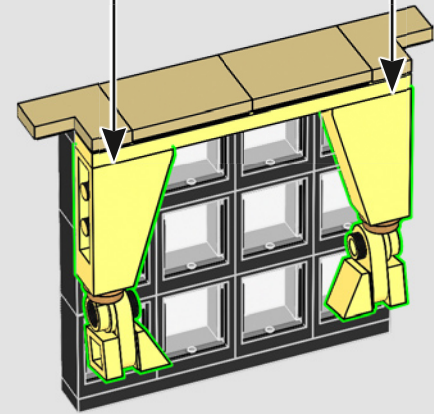
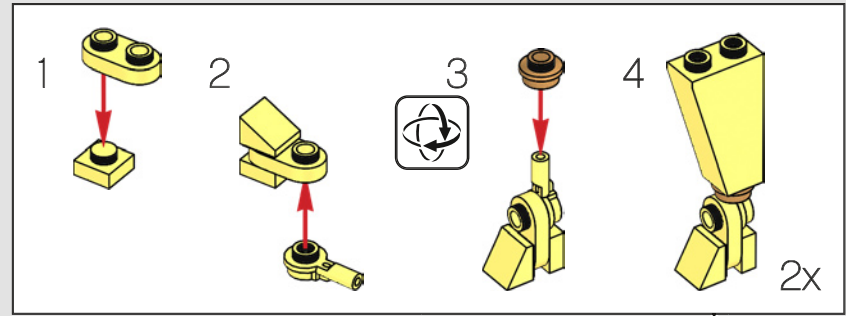

132



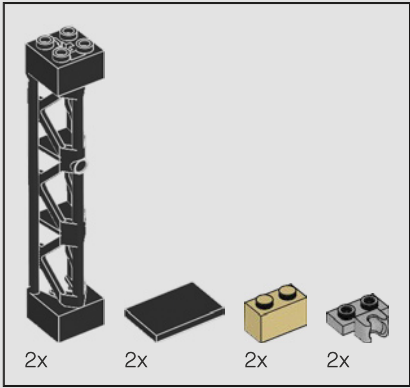
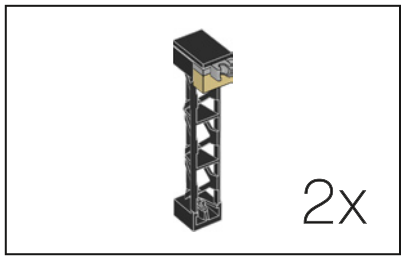

133

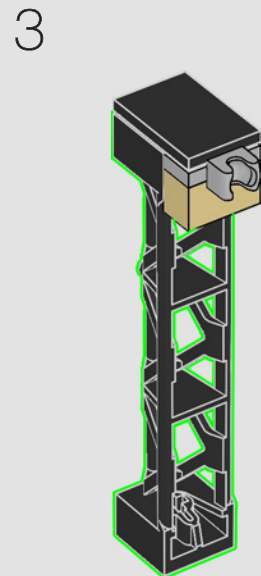
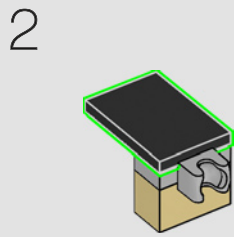
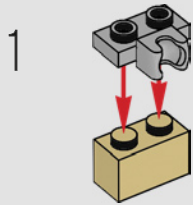



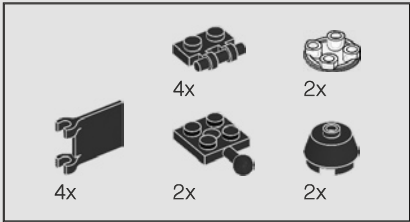
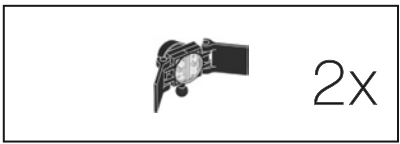

134

1



2

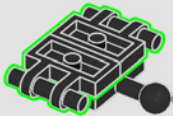

3



4

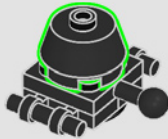

5

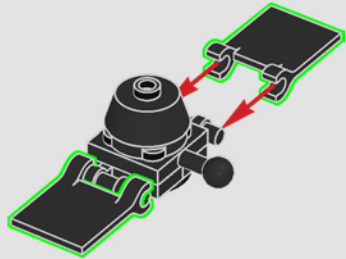

2x



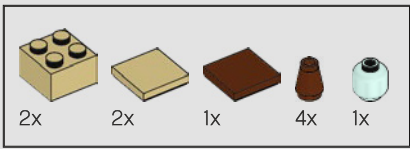

135

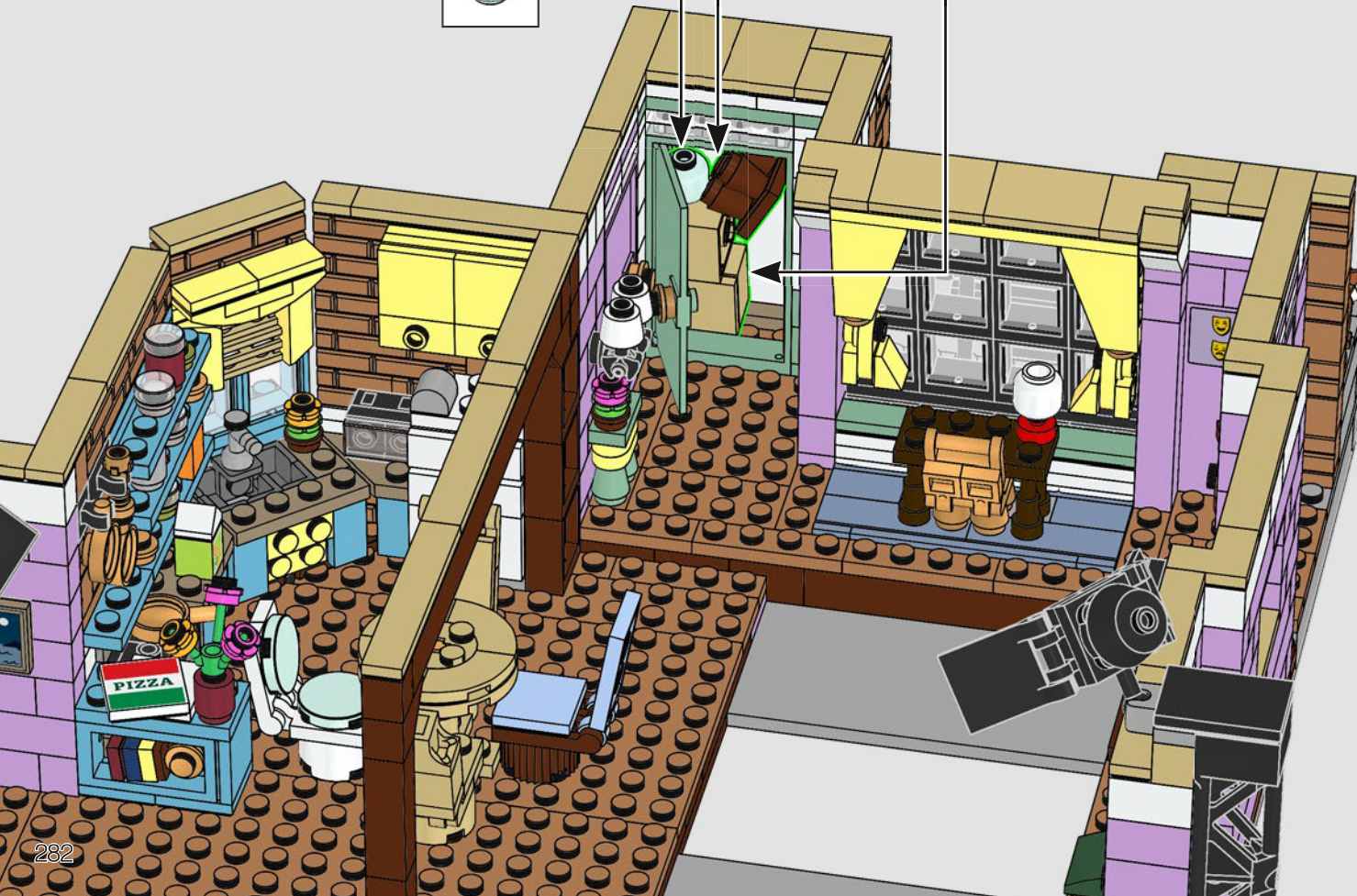
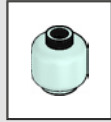
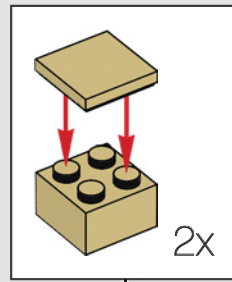
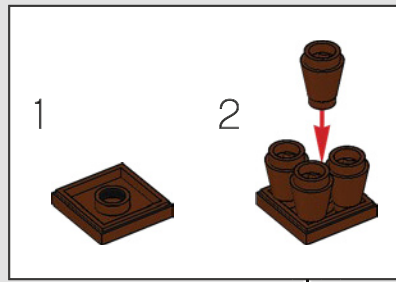

● The closet, stuffed full of junk, was tidy Monica's hiding spot for all her mess.

● Le placard plein à craquer que la très ordonnée Monica utilisait pour cacher son désordre.

● El clóset, atiborrado de todo tipo de cosas, es donde Monica escondía todo su desorden.



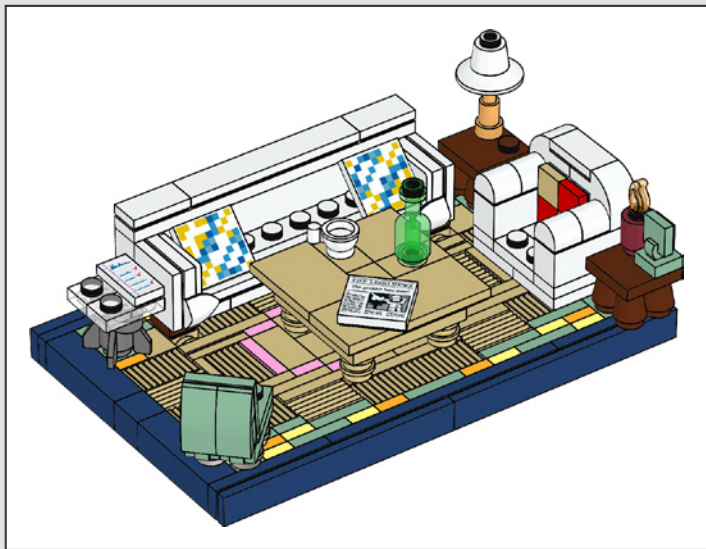

136



137



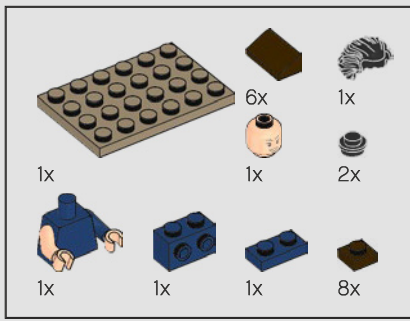

138

Meet Gladys, the ugly, awful sculpture made by Phoebe that she thought was wonderful but everyone else hated.

Voici Gladys, l'épouvantable sculpture faite par Phoebe qui la trouvait merveilleuse, mais que tout le monde détestait.

Conoce a Gladys, la horrenda escultura hecha por Phoebe. Ella la consideraba maravillosa, aunque a todos los demás les pareciera espantosa.



1

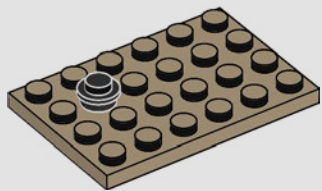

2

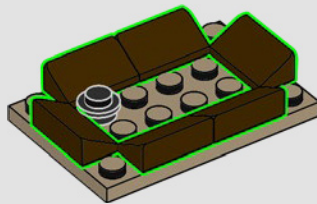

3

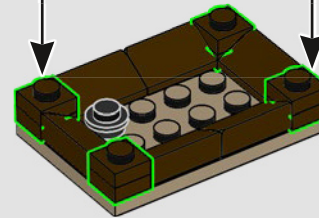

4

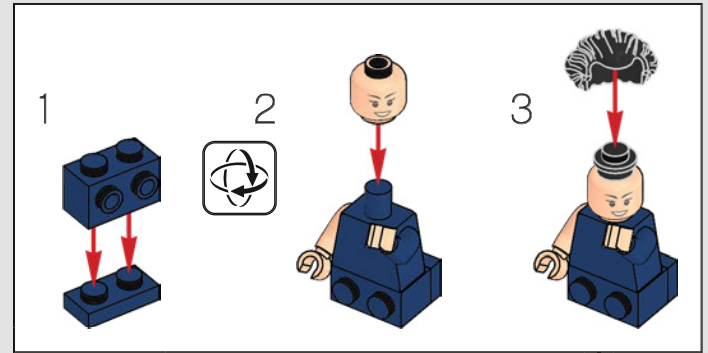
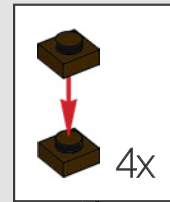
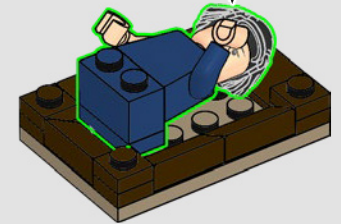

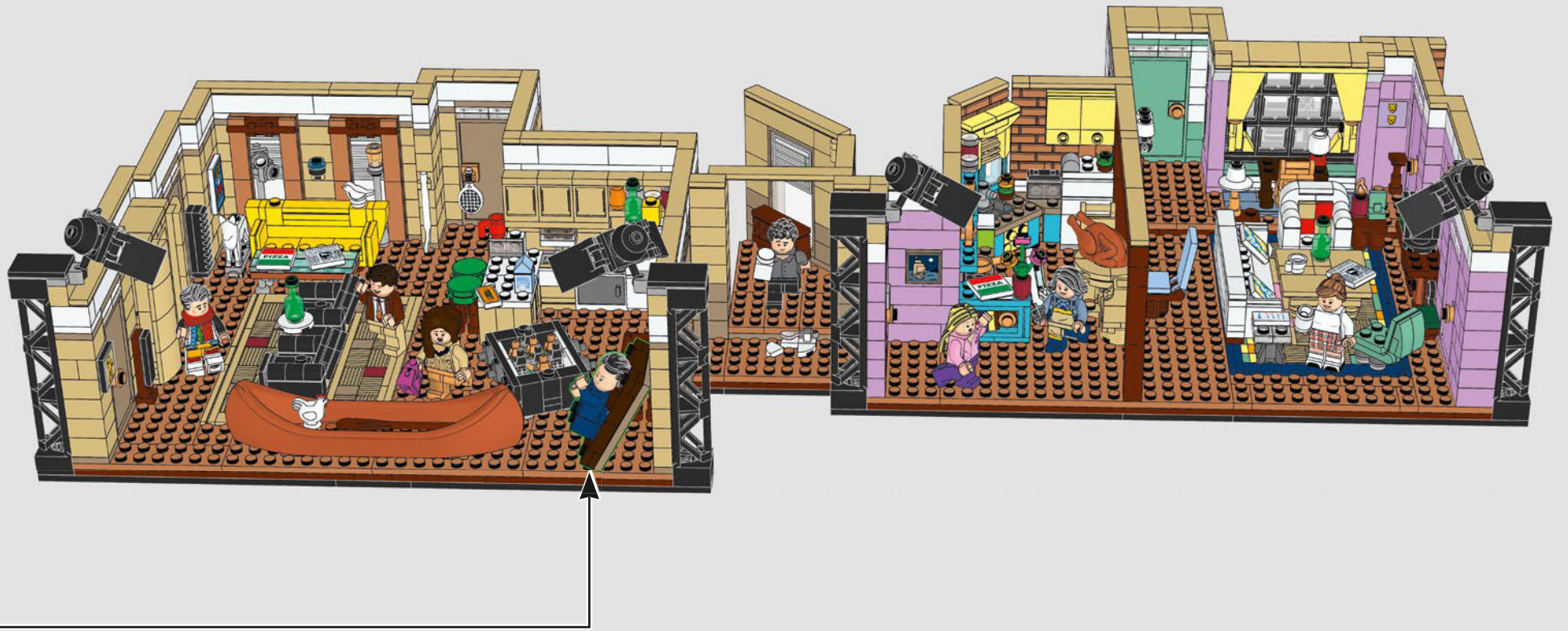



FEEDBACK AND WIN



FEEDBACK AND WIN

Your feedback will help shape the future development of this product series.

Please visit:

FEEDBACK UND GEWINNEN

Dein Feedback trägt zur Weiterentwicklung dieser Produktreihe bei.

Geh auf:

COMMENTEZ ET GAGNEZ

Vos commentaires nous aideront à concevoir les futurs produits de cette gamme.

Rendez-vous sur :

COMENTA Y GANA

Tu opinión nos ayudará a dar forma al desarrollo de esta serie de productos en el futuro.

Visita:

反馈有奖

您的反馈将有助于我们在今后改进本系列产品。

请访问：

LEGO.com/productfeedback

By completing, you will automatically enter a drawing to win a LEGO® set.

Terms & Conditions apply.

Durch Ausfüllen nimmst du automatisch an der Verlosung eines LEGO® Preises teil.

Es gelten die Teilnahmebedingungen.

En envoyant vos commentaires, vous serez automatiquement inscrit(e) à un tirage au sort qui vous permettra de remporter un prix LEGO®.

Offre soumise à conditions.

Al contestar, participarás automáticamente en el sorteo y podrás ganar un set LEGO®.

Sujeto a Términos y Condiciones.

完成我们的反馈调查，即可自动进入抽奖环节，赢取乐高®套装。

适用《条款和条件》。



1x 6276148	2x 654101	2x 6285777	2x 6361170	2x 6104805	1x 6360037	1x 6236423	9x 6221467	7x 6175367	1x 4113993	3x 4143005
1x 4518400	3x 6218841	10x 302301	8x 362201	2x 4560178	2x 6252969	2x 6313119	8x 6046924	11x 4550324	1x 4113993	1x 6299413
1x 6284572	10x 300501	6x 306901	9x 362301	10x 300901	4x 4179771	1x 6364438	4x 4185177	15x 4113233	4x 4114324	4x 302424
1x 6052312	2x 6046905	4x 6218823	3x 4558168	1x 663601	8x 4579260	2x 4124456	1x 4114084	1x 4201062	10x 4544139	2x 4624985
3x 6173141	1x 6063275	4x 6070327	1x 6256050	2x 379501	20x 4113915	4x 6092587	8x 6173057	18x 4113916	5x 4143409	1x 300524
1x 6253309	1x 474001	4x 6070698	1x 6021730	6x 346001	6x 6057517	3x 4205107	4x 6226565	1x 6146877	1x 6284574	4x 403224
1x 362601	1x 614301	6x 6097637	1x 6021730	1x 416201	17x 6232135	8x 4578107	2x 4114306	1x 6302268	1x 6215539	2x 6092583
1x 6263451	1x 6093053	2x 6290444	7x 302101	1x 416201	8x 6256080	2x 6335307	2x 4114077	1x 6146877	2x 307021	2x 6208753
1x 6235083	1x 6338819	2x 6175184	5x 6156667	1x 300801	1x 4140562	17x 4114026	33x 4124455	1x 6302268	2x 307021	2x 306824
1x 302401	1x 6350040	1x 6126046	2x 6218212	2x 447701	1x 4125220	10x 4162465	10x 4124455	1x 4114309	1x 389921	2x 306824
1x 6348055	1x 6329599	2x 306801	2x 6218212	2x 447701	1x 4125220	5x 4121921	10x 4124455	1x 4114309	1x 6298924	3x 6224666
2x 407001	1x 6192534	1x 302201	2x 306801	1x 4619665	2x 4218749	1x 6061575	5x 4121921	2x 4124067	5x 403221	2x 4247771
3x 6172366	1x 6192534	1x 302201	1x 306801	1x 4619665	2x 4218749	7x 6211966	1x 6061575	2x 4124067	2x 302321	2x 302124
4x 6258135	2x 366501	10x 242001	1x 300201	1x 300201	40x 4655900	1x 6211966	1x 6061575	21x 4112982	1x 300121	2x 371024
2x 4558952	8x 300401	5x 235701	17x 301001	1x 300201	1x 4107623	6x 6214334	7x 6211966	2x 4124067	1x 4112982	2x 302124
1x 6286834	1x 6058177	2x 4515364	6x 371001	2x 417070	10x 4161734	1x 6334219	2x 6211966	11x 4157277	1x 4113858	1x 243124
				2x 6230284	2x 6230284	3x 4217562	2x 6211966	1x 4243824	1x 6130004	1x 300924
				9x 4125253	36x 4109995	2x 4565387	2x 4118790			



- 2x 6111685
- 1x 6262030
- 7x 6001824
- 2x 6231386
- 2x 6015449
- 13x 4528604
- 7x 4521914
- 8x 6310835
- 1x 4633881
- 5x 6310830
- 17x 4550168
- 4x 6344040
- 5x 6328307
- 1x 6035540
- 11x 4626904
- 4x 6001822
- 8x 6262970
- 2x 6038637
- 3x 4267874
- 1x 6015424
- 1x 4247151
- 7x 6156492
- 1x 6167894
- 4x 4184108
- 4x 4255413
- 3x 6345563
- 1x 6338823
- 1x 4528981
- 2x 6135606
- 4x 4502089
- 2x 4507080
- 4x 6250216
- 1x 6101285
- 2x 6134280
- 1x 6223913
- 8x 6099189
- 4x 6009656
- 1x 6348059
- 2x 6360112
- 18x 4655080
- 2x 6278553
- 2x 4616581
- 1x 6186823
- 1x 6133896
- 2x 6258387
- 1x 6346547
- 2x 4521947
- 3x 6192923
- 1x 6342692
- 4x 4539099
- 1x 4550169
- 2x 4541376
- 3x 6357747
- 1x 6172233
- 2x 6209681
- 11x 6073040
- 1x 6359662
- 1x 6284586
- 12x 4529242
- 10x 4216581
- 3x 4211242
- 6x 6348057
- 1x 6149677
- 8x 4221744
- 2x 4211288
- 2x 6177699
- 1x 4620075
- 2x 6201911
- 9x 6238874
- 1x 6174229
- 1x 6167879
- 2x 6153863
- 1x 6036503
- 2x 4223303
- 2x 6092590
- 5x 4211150
- 4x 4211151
- 3x 4595814
- 2x 4211222
- 13x 6310449
- 2x 6273865
- 1x 4271949
- 7x 4216695
- 2x 6196221
- 4x 6102975
- 2x 6116613
- 5x 4211189
- 2x 4216668
- 3x 4211190
- 1x 4211194
- 1x 4283660
- 7x 4211186
- 6x 4221590
- 2x 4609635
- 1x 4211247
- 4x 4263776
- 14x 4211211
- 1x 4217848
- 8x 4223683
- 3x 4211207
- 1x 4211214
- 3x 6096716
- 1x 6258989
- 2x 6170418
- 1x 6249246
- 2x 4211412
- 3x 6284071
- 2x 4529241
- 4x 4211525
- 1x 6168647
- 5x 4211503
- 1x 4211483
- 2x 6286223
- 2x 4211476
- 2x 6308012
- 3x 6262085
- 2x 4211415
- 2x 4558953
- 2x 4213567
- 1x 6311384
- 4x 6261375
- 4x 6043656
- 3x 6066097
- 2x 4211388
- 1x 4211398
- 1x 4211414
- 1x 6261353
- 2x 4211428
- 1x 4211429
- 1x 4211396
- 2x 4211636
- 2x 4211394
- 1x 4211549
- 1x 4211837
- 1x 4211392
- 1x 4211404
- 4x 4211521
- 1x 4211405

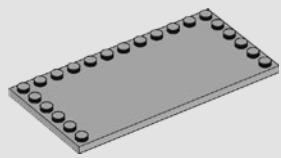

4x
4211836

4x
6271752

5x
6025235

1x
6225494

1x
6331222

3x
6221607

1x
4210811

2x
6284702

1x
6228085

1x
6162894

1x
6360050

3x
6209679

4x
6031883

2x
4654128

2x
6002148

21x
6058014

2x
6296498

4x
6296501

2x
6296963

2x
6296510

1x
6346546

2x
6195266

2x
6061201

2x
6296507

2x
6222971

2x
6286832

2x
6316265

3x
6296521

3x
6248756

2x
6296524

1x
6248761

1x
4586410

1x
6338817

1x
6338820

1x
6343013

1x
6338824

1x
6338826

1x
6338828

1x
6338831

1x
6162427

1x
6347939

1x
6347975

1x
6347849

1x
6347981

1x
6348014

1x
6347824

1x
6347873

1x
6347869

1x
6003147

4x
6335932

4x
4529247

2x
6190252

12x
4523159

1x
6262138

2x
6284379

3x
6138068

1x
4512021

2x
4538126

2x
4585493

4x
6109752

2x
6287425

4x
6092674

1x
6248486

3x
6097419

5x
4649741

1x
6286836

3x
6060857

2x
4619513

1x
6070757

2x
6036238

2x
4655256

2x
4625036

3x
6146926

1x
6093529

8x
6194729

1x
6223146

6x
6127366

1x
6348012

4x
4538950

1x
6226792

20x
6057986

6x
6215606

1x
6093260

6x
6218360

21x
4656783

2x
6102994

4x
6056383

2x
6177535

8x
6102998

20x
6055309

15x
6167700

12x
6093494

4x
6295464

6x
6226644

1x
6346548

24x
6218145

2x
6272111

1x
6196796

7x
4633691

2x
6215447

1x
4624615

1x
6175870

2x
6096948

1x
6125776

23x
6097053

15x
6099190

31x
6099352

4x
6290505

4x
6344038

1x
6273909

2x
6258990

4x
6217492

3x
6217498

16x
6097870

14x
6097867

4x
6344416



Customer Service
Kundenservice
Service Consommateurs
Servicio Al Consumidor
LEGO.com/service or dial



: 00800 5346 5555
: 1-800-422-5346

